

# C.A.K.

The **CATALOGUE**

45<sup>th</sup> 2013  
EDITION

40 years   
Quality - Innovation - Value

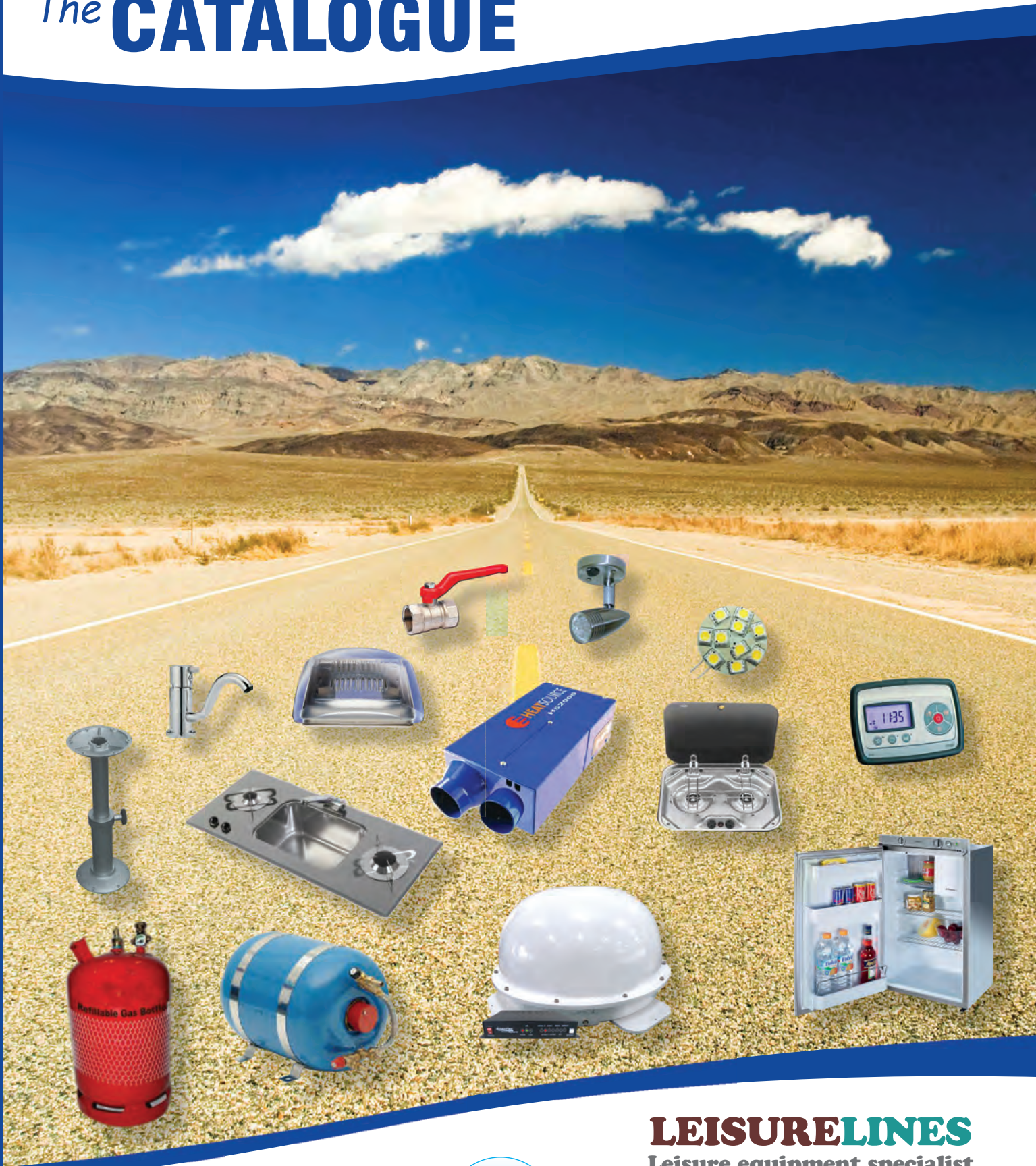

**SupremeTech**  
Installation - Service - Repair



**LEISURELINES**  
Leisure equipment specialist

**NAUTIC PRODUCTS**

The Complete Water Systems & Interior Equipment Specialist

# WELCOME TO THE 45th C.A.K. TANKS CATALOGUE

There are many ways we can be of service to you.....

## The CATALOGUE...

The 130 page Mail Order catalogue in your hand has a considerable selection of our range of equipment. It provides a gateway to our full range of products and services. We are with you whenever you need our assistance, be that new equipment or an urgent spare part while you are on holiday. We ship throughout Europe and worldwide to wherever you are. Join our thousands of satisfied customers! For over 4 decades, our reputation as a successful manufacturer and supplier has grown from strength to strength and much of this success can be attributed to our ability to offer great value with unparalleled customer service to match.



Quality - Innovation - Value  
The Complete Water Systems  
& Interior Equipment Specialist



## Visit our Warehouse Store in Kenilworth...

Our retail front counter is located within our warehouse in Kenilworth. We're open Monday to Thursday from 8am to 5.15pm, Friday 8am to 4.30pm and closed holidays. We have a lot of the small components on display, but there's not much browsing possible because most products are boxed for Mail order shipping. But tell us what you want and we'll go grab it from our massive selection for you to look at. It's no trouble at all. We will also offer you technical advice to help you choose the best match of products to fulfill your needs. Our on-site Technical centre can offer you service assistance also. Obtain expert advice from our highly trained and friendly sales team. With such a huge product range and so many items to choose from, be rest assured our knowledgeable staff will help you choose the right products to suit your needs and ensure hassle free use of your purchase.

**Important note:** Our stock changes drastically all day, every day. Please call ahead to verify stock of any MUST HAVE items.

## Visit our New Online Shop...

### LEISURELINES.net

#### Leisure Equipment Specialist

Our products are now available to purchase at your convenience in our online store. There is mainly our catalogue range online, we have many more products and extensive spare parts available direct from our warehouse. The webstore of CAK Tanks Long established and most respected manufacturer and supplier of Caravan, Motorhome & Narrowboat equipment. Visit our premises for full back up,

*Quality service and support we are NOT just a website!!*



## Have our Technical Centre assist you...



### SupremeTech

#### Installation - Service - Repair

#### YOUR FRIENDLY SERVICE & FITTING CENTRE

WE CAN CARRY OUT ALL REPAIRS, SERVICING AND ANNUAL CHECKS AT OUR WORKSHOP WHICH IS CONVENIENTLY SITUATED ON THE OUTSKIRTS OF KENILWORTH AT PRINCES DRIVE INDUSTRIAL ESTATE. WE ARE ALSO ABLE TO SUPPLY AND FIT NEW EQUIPMENT AND ACCESSORIES TO YOUR MOTORHOME, CARAVAN, HORSEBOX OR SPECIAL VEHICLE - ALL AT A TIME CONVENIENT TO YOU

CALL or E-MAIL FOR A QUOTE OR TO MAKE A BOOKING  
Tel: 0844 414 2630 / E-Mail: sales@supremetech.co.uk  
www.supremetech.co.uk

IF YOU PREFER TO USE YOUR MOBILE PLEASE TEXT:-  
CAK(space)SERV(space) Your Name and Query (maximum 140 characters) to 60777 and we will call you back.



We can handle horseboxes (subject to workshop height restriction)



Email your requirements Or contact us on the good old fashioned Phone

**ORDERLINE 0844 414 2324      FAX: 0844 414 2425**

**sales@caktanks.com      www.caktanks.com**

**Trade & Export enquiries: sales@caktanks.co.uk**

**OVER 45 YEARS DEDICATED SERVICE TO THE LEISURE INDUSTRY**

**WATER TANKS** *Pages 7-18*

Fixed Tanks	Wheeled Tanks	Portable Canisters
Tankleen	Under Chassis	Aqua Tanks

**WATER TANKS - ACCESSORIES** *Pages 19-23*

Water Fillers	Tanks Insulation	Easy Drain Valves
Fuel Fillers	Access Caps & Hatches	Solenoid Valves
Cassette Hoses	Discharge Hose	Supadrain
Fillmate	40mm Rigid Tubing	Mega Drain
De-Frost Elements	Valterra Valves	Ultra Drain
USA Slide Valves		Slide Valves

**WATER - PLUMBING** *Pages 24-26*

28mm Semi-Rigid Waste	Pipe Cutters	Drain Taps
Smell Traps	Reinforced Hose	Strainers
Non-Return Valves	Supaflex Hose	Hose Sockets
Skin Fittings	Hose Connectors	Quick Connectors
	Hose Clips	Push Fit Plumbing

**WATER - PUMPS** *Pages 27-29*

Shurflo Accessories	Portable Shower Pumps/Accumulator	Foot Switches
Comet Pumps	Whale Pumps	Strainers
Whale Supafill	Surge Damper	Non Return Valves
Whale Portable	Whale Submersible	Watermaster
	Whale Inline	Aquasource Mains

**WATER - TAPS & SHOWERS** *Pages 28 & 30-35*

Whale Single & Mixers	Simple Taps	Deluxe
Combination	Surge Damper	Ultimate
External Showers	Aquasource	Accessories
Shower Heads	Filters	Spares
	Mixer Units	Microswitches

**KITCHEN SMEV** *Pages 36-45*

Hobs	Marine Cookers	Dish Racks
Worktop Waste Bin	Cutting Boards	Ovens
Mini Grill	Sinks / Drainers	Glass Covers
Sink Wastes	Cooker Hoods	Cramer
Combo Units	Sink Base Mats	Glass Hobs

**FRIDGES** *Pages 46-50*

Thetford Dometic	Cooling Fans	Compressor
3 Way Gas	Vents	Freezers
	WAECO	Drawer Fridges

**HEATING** *Pages 51-57*

Propex Truma	Convactor	Radiators
Webasto Diesel	Blown Air Ducting	Thermostatic Valves
Calorifiers	Gas Fittings	Isolation Valve
	Whale	Awning Kit

**GAS** *Pages 58-62*

Leak Detector	Gas Tanks	PTFE Tape
Aerosol	Regulators	Lined Pipe Clips
Gaslow Refillable	Fittings	Truma Remote
Hose & Pigtails	LPG Sticker	GAS IT Refillable
Bottle Spanners	Copper Pipe	

**TOILETS** *Pages 63-67*

Thetford Cassettes	Dometic Porta Pottis's	Chemicals
Slide EZ-Valves	Electra Magic	Bravura
SOG Units	Service Doors	Aqua Magic Mk.V

**BATHROOM** *Pages 68-69*

Baths	Shower Mats	Tip-Ups
Shower Trays	Shower/Awning	Cabinets
Sink Wastes	Decking	Washbasins

**VENTILATION** *Pages 70-74*

280 X 280 Series	Spoilers	Seitz
400 X 400 Series	Fiamma	Heki
Sol-A-Vents	Fixed Vents	Ventilation Fans
Trav-L-Cool	Dometic	Air Conditioning

**LIGHTING** *Pages 75-84*

Replacement Bulbs	Halogen Lighting	Fluorescent
LED Lighting	Waterproof	Exterior / Awning

**ELECTRICAL** *Pages 85-101*

TV Aerials	Control Systems	Oscillating Fans
CO Alarms	Gas Alarms	Consumer Units
Fuses + Resettable	Battery Chargers	Hair Dryer 12V
ALKO	Fuse Boxes	Iron 12V
Water Level Gauges	Mains Input Lead	Inverters
Tank De-Frost	Mains Input Sockets	Droppers
Elements	Switches	Converters
Solar Panels + Kits	Sockets	Temp Gauges
Relays	CBE / Berker	Voltage Gauges
Televisions	Satellite	Generators

**DOORS & LOCKS** *Pages 102-103*

Heosafe Cab Locks	Zadi Locks	Thetford Doors
Door Frames	Exterior Locks	Wet Lockers
Door Retainers	Battery Boxes	
Door Locks	Access Flaps	

**CAB SCREENS** *Page 104*

Thermal Screens	External DIY Fabric	Suction Cups
		Eyelets

**PUBLICATIONS** *Page 105*

Haynes	John Wickersham	Lindsay Porter
--------	-----------------	----------------

**FURNITURE FITTINGS** *Pages 106-111*

Barkeepers	Magazine Net	Furniture Board
Push Button Locks	Locker Door Stays	Wall Board
Folding Supports	TV Brackets/Swivels	Edging
Door Catches	Carrier Bag Holder	Slotting Tools
Bed Slats	Handles	Hinges

**FURNITURE FITTINGS - TABLES** *Pages 112-114*

Folding Legs	Flap Supports	Telescopic Table
Island Legs	Table Slide Bars	Support (Electric)
Swivel Table Leg	Lowering Frames	TV Mounts

**SEALANT & FIXINGS** *Page 115*

Sikaflex	Butyl	Screw Packs
Silicone	Spray Adhesive	Bolt Packs

**INTERIOR** *Pages 116-119*

Windows	Luggage Nets	Rock N Roll Hinge
Bunk Safety Nets	Curtain Rail	Lining Carpet
Chains / Padlocks	Curtain Fittings	Vinyl Flooring
Garage Matting	Acrylic Mirror Tiles	Seating Fabric
Door Curtains	Window Wash Rack	Ratchet Straps
Garage Rails	Bunk Ladders	Edge Finishing

**EXTERIOR** *Page 120-121*

Stabilising Jacks	Exhaust Finishers	Levelling Blocks / Chocks
Access Ladders	Entrance Steps	
Dometic Awnings	Carefree Awnings	

**ENTRANCE STEPS** *Pages 122-123*

Manual	Step Mats	Uniko 6-in-1
Electric	Slide Out	Uniko Ramp Profile

**SAFETY** *Page 124*

Hi Viz Vest	Spare Bulb Kits	Warning Triangle
Fire Blanket	First Aid Kit	Auxiliary Mirror
Fire Bucket	Blindspot Mirror	Fire Extinguishers

**SEAT SWIVELS** *Page 125*

FASP	MAPA	BASIC
------	------	-------

**MARINE** *Pages 126-131*

SEE SEPARATE MARINE INDEX ON PAGE 131

**PETS ON TOUR**

See our website [www.caktanks.com](http://www.caktanks.com)

**CLEARANCE CENTRE**

See our website [www.caktanks.com](http://www.caktanks.com)



# TANKS ORDERING INFORMATION (Please read before going any further)



Water Tanks

Buy securely online at [Leisurelines.net](http://Leisurelines.net)

Our one piece heavy duty polyethylene moulded plastic tanks (wall thickness from 4 mm to 12 mm depending on size) can be fitted with our welded hose fittings during production to suit any application or requirement at no extra cost. Our tanks are designed for the safe, reliable storage and transport of drinking water & grey or black waste water, industrial chemicals and much more (not designed for petrol or paraffin fuel storage). They are available in a wide variety of shapes and sizes; we offer the most extensive range of 250+ sizes. Every effort is made to ensure Tank sizes and capacities are accurate, but due to the production process variations can occur. Rotomoulded to be seamless, one-piece, watertight vessels, our tanks will not leak, split, rust or corrode. All our tanks are manufactured to meet the requirements for food and water collection. All our tanks are moulded; they are not welded together from flat sheet plastic with joins that will crack prematurely. Because our tanks have no joins it ensures a very long and trouble free life.

The tanks are black to prevent the growth of algae so your fresh water will stay fresh longer with no aftertaste. Don't be put off by the colour we only use the highest grades of virgin polymers to produce our tanks. Being black no light can enter to the water and therefore no algae and other organisms can grow therefore there will be no bad tastes, your fresh water will stay fresh longer. It is important to use food quality hoses as most water tastes come from the waterborne chlorine leaching plasticizers out of the flexible hoses, leaving a medical/plastic taste (blue hose syndrome). Most of our smaller tanks have anti surge baffles; a C.A.K. TANKS patented Invention, to prevent excessive water movement. Being moulded and having no joins ensures a long and trouble free life. We cannot make tanks to individual made to measure sizes as all our tanks require a mould. For bulk requirements of 100 items a mould could be made.

### AVAILABILITY

All tanks are usually held in stock but required fittings are installed to individual needs from customer supplied drawings and therefore there is a turnaround time for production. Please order in plenty of time as in busy periods you can wait up to three-four weeks for delivery. IF YOU REQUIRE A TANK MORE URGENTLY HAVE A LOOK AT OUR BLUE AQUA TANKS WHICH ARE AVAILABLE FROM STOCK FOR YOU TO INSTALL YOUR OWN NUT IN FITTINGS ( see catalogue page 24)

### TANK PRICE INCLUDES

Welded hose fittings in a position to suit your requirements. Welded hose fitting sizes available:- Straight fittings 40mm, 1 1/2", 1", 3/4", 15mm, 1/2", 12mm, 10 mm. For individual fitting requirements please send sketch of drain tap & hose fitting positions with order. See reverse of order form. **We do not take verbal instructions for the positioning of tank fittings, WE MUST RECEIVE A SKETCH OF THE POSITIONS. See price list for guidance on what information is needed on your drawing. Nut in fittings are at extra cost.**

### ADDITIONAL EQUIPMENT INSTALLATION

Level indicators, hatches & sub pump adaptors can be fitted to black tanks while in production at no extra charge for labour.

### TANK PRICE INCLUDES

Welded hose fittings in a position to suit your requirements. Welded hose fitting sizes available:- Straight fittings 40mm, 1 1/2", 1", 3/4", 15mm, 1/2", 12mm, 10 mm. For individual fitting requirements please send sketch of drain tap & hose fitting positions with order. See reverse of order form. We do not take verbal instructions for the positioning of tank fittings.

### TO FIND YOUR TANK

The tanks appear in the catalogue in length order with longest size first. Firstly look in the vehicle applications table to see if your vehicle is listed. If it is, you must measure to confirm the tank will fit where it is intended to go. Many vehicles are modified in some way from the manufacturers' standard that could prevent the standard tank from fitting. If your vehicle is not in the list, find the maximum length you have and work through the catalogue tank lists to find the best tank shape to fit your available space. Although tanks may be marked F or W (Fresh or Waste) they can be used for both applications, but you will need to inform us how you intend to connect the tanks. Our tanks cannot be used for petrol or diesel. Year information: <98 means up to and including that year, 98> means that year and after.

### IN ORDER TO ENSURE THE TANK YOU ORDER WILL FIT YOUR NEEDS WE RECOMMEND THE FOLLOWING:

- Carefully measure the available space (length, width and height) whether it is under the chassis, in a bed box etc. where you plan to install your tank. Since these tanks are generally rectangular in shape, keep in mind they may be used in any position, though if placed up on edge, they will need bracing and supporting. Plan for additional space when fittings and/or fill lids are required. Fittings in general protrude around 60mm (2.5 ")
- Remember that most of our tanks are one piece sealed mouldings. This means there are no predetermined access holes. If you want to fill and empty the tank, which we assume you do, you will want to select fittings and accessories that are appropriate for your project. See our entire selection of tank fittings, filler caps and lids, in our catalogue. Tanks marked FRC, RRC & MTC have the option of our fully sealed cap at a specific position on the tank. If you require an access cap in the base of your tank only tanks with RRC are suitable, unless you specify our 10" hatch THSO10 to be installed. No other caps or hatches are suitable to be installed in the base.
- Once you have selected the fittings that are necessary to complete your project, fill out our Order Form. And enclose a suitable sketch drawing for tanks where you wish us to place fittings in a non standard application. You can of course order the tank plain and order separately an Access Cap / Hatch and a selection of Nut In Fittings to assemble the tank yourself.
- It is very important to be as precise as possible when specifying tank fittings and accessories. Location, type and size of fittings must be noted clearly on your drawing. If more than one fitting is being specified, mark each fitting with a letter A, B, C etc. and identify the size and use of each fitting next to your drawing. I.e. 40mm Filler, 10mm vent/breather/overflow, 15mm Pump connection and 25mm drain connection. See back of order form for sizes available. Dimensional drawings are available for all tanks in the catalogue. Copy and enlarge a drawing and send or fax in with your order. Mark tank drawing top, front, back, side & bottom to identify which way up you are using tank.

### EXAMPLE ORDER.

Indicate width, length and height of tank using inches or millimetres.

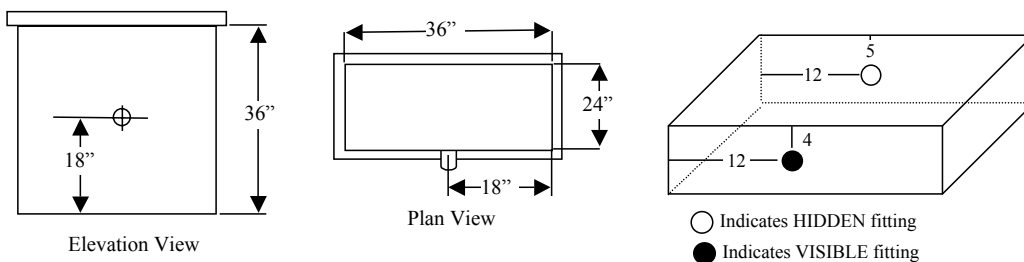

Plan View: indicate the distance of the connection from edge of tank.

Elevation View: indicate in inches or millimetres the height from the centre of the fitting to the base of the tank. Or mark connection as low as possible.

Example: 36" long x 24" wide x 36" High. Fitting is 18" in from end along the 36" sidewall, 18" up from base.



### CAKTSC100 TANKKLEEN FRESH WATER TANK CLEANER & STERILISER.

Tankklean is the only product we recommend for cleaning C.A.K. Tanks and water systems. It is very safe and leaves no after taste as it is used also for cleaning winemaking equipment. Do not be tempted to use chlorine based cleaners as they will attack piping and other plastics leaving a nasty medical taste (See Page 63).



### TLFR15 THETFORD TANK FRESHENER

Recommended by C.A.K. Tanks for waste tank cleaning. Thetford Tank Freshener reduces deposits and grease contamination in your waste tank and pipework. Prevents unpleasant smells, improving hygiene, while promoting trouble free discharge of your tank. The pleasantly pine-scented thickened non-drip formula is not harmful to the environment and safe on all plastics.

Not for fresh or toilet waste tanks. (See page 63).

WE NOW OFFER INSTALLATION & REPAIR SERVICE BY [SupremeTech.co.uk](http://SupremeTech.co.uk)

BELOW WE HAVE LISTED THE CONTENTS OF KITS. YOU DO NOT HAVE TO HAVE THESE KITS YOU CAN ORDER ITEMS INDIVIDUALLY. CODES AND PRICES HAVE BEEN LISTED HERE FOR YOUR CONVENIENCE. TANKS AND KITS DO NOT COME WITH FITTING INSTRUCTIONS, SO IF YOU ARE UNSURE AT THE TIME OF FITTING PLEASE PHONE TECHNICAL DEPARTMENT.

**STANDARD KITS TYPE F AND W. WILL BE SUPPLIED WHEN ORDERING STANDARD KITS (Only available where marked)**

Within the applications list we show a number of kits for tanks to fit specific vehicles, though you may find other tanks will fit in alternative positions. Please measure to ensure the tank you order will fit your vehicle as many vehicles are modified or manufacturers make base vehicle changes in production. For standard kits you do not need to send in a tank drawing. If you find a standard tank will not fit your vehicle, please find an alternative tank from the list and make up the required kit from the individual items within the price list (see kit contents below as a guide). The kit price includes tank fittings where appropriate and installation kit.

**STANDARD FRESH KIT TYPE F KIT CONTENTS (THIS IS WHAT YOU WILL RECEIVE IF ORDERING A STANDARD FRESH TANK KIT) FOR A F20SHORT BLACK FILLER ORDER FB KIT. FOR A F23SHORT WHITE WATER FILLER ORDER FW KIT.**

Fresh Water Tank tailored with hose connections to suit the vehicle, (40 mm inlet, vents, 15 mm pump connector & 1" outlet to fit remote drain tap DTB).

CODE	QTY	DESCRIPTION
F**SHORT	1	WATER FILLER LOCKING
H4S	1 M	40MM SUPAFLEX HOSE
HC4	2	40MM HOSE CLIPS
TB2	1	SET OF FIXING BRACKETS
HBSET4	1	SET OF 4 X 4" HOOKBOLTS
DWO	1	DRINKING WATER STICKER
4RTB	1	BLUE REMOTE TAP KIT 4"



STANDARD KIT F

**STANDARD WASTE KIT TYPE W KIT CONTENTS (THIS IS WHAT YOU WILL RECEIVE IF ORDERING A STANDARD TANK KIT)**

Waste Water Tank tailored with hose fittings to suit the vehicle, (one or more inlets 3/4" 20 mm, vents, & 1" outlet to fit remote drain tap DTG).

CODE	QTY	DESCRIPTION
TB2	1	SET OF FIXING BRACKETS
HBSET4	1	SET OF 4 X 4" HOOKBOLTS
WDS	1	WASTE DRAIN STICKER
4RTG	1	GREY REMOTE TAP KIT 4"



STANDARD KIT W

SOME TANKS IN STANDARD KITS WILL RECEIVE A WELDED CRADLE INSTEAD OF A SET OF BRACKETS (Boxer fresh & T5 waste etc). Ducato, Relay or T5 waste kits have 1 x mtr of H2S supaflex to remote mount the waste drain tap. VW T4 fresh kits have a floor support angle in the kit.

NEW VW T5 FRESH TANK KIT. T5 STEP AND T5 SKIRT TANK PAIR WITH SPECIAL FITTING KIT INCLUDING TANKS USE KIT CODE CAK-T5PAIRB FOR KIT WITH BLACK FILLER OR KIT CODE CAK-T5PAIRW FOR KIT WITH WHITE FILLER.

**FOR TANKS WHERE A STANDARD KIT IS NOT AVAILABLE PLEASE ORDER ONE OF THE FOLLOWING. ORDER UF\*\*B FOR BLACK FILLER OR UF\*\*W FOR WHITE FILLER.**

**UF20 UNIVERSAL FRESH KIT TYPE UF20 KIT CONTENTS (FOR TANKS UP TO 20 GALLONS, 100 LITRES)**  
F\*\*SHORT Locking water filler (black or white as applicable), 1 M H4S 40 mm supaflex inlet hose, 2 X 40mm HC4 hose clips, one set of UTMK fixing strap kit, DWO drinking water sticker, 4RTB remote drain tap.

**UF40 UNIVERSAL FRESH KIT TYPE UF40 KIT CONTENTS (FOR TANKS 20 TO 40 GALLONS, 100-200 LITRES)**

F\*\*SHORT Locking water filler (black or white as applicable), 1 M H4S 40 mm supaflex inlet hose, 2 X 40mm HC4 hose clips, two sets of UTMK fixing strap kit, DWO drinking water sticker, 4RTB remote drain tap.

**UW20 UNIVERSAL WASTE KIT TYPE UW20 KIT CONTENTS (FOR TANKS UP TO 20 GALLONS, 100 LITRES)**

One set of UTMK fixing strap kit, WDS waste drain sticker, 4RTG remote drain tap & hose clips.

**UW40 UNIVERSAL WASTE KIT TYPE UW40 KIT CONTENTS (FOR TANKS 20 TO 40 GALLONS, 100-200 LITRES)**

Two sets of UTMK fixing strap kit, WDS waste drain sticker, 4RTG remote drain tap & hose clips.

In cases of requiring larger capacities two or more tanks can be linked together by means of 1" (25 mm) straight connectors on tank side's one top & one at base. This application is particularly useful for Narrowboats where hatch access is restricted.

**UNIVERSAL TANK MOUNTING KIT**

A neat set of punched strap and mounting fastenings to bolt tank through the floor. Tanks up to 20 gallons (100litres) require one set of UTMK. Tanks from 20 to 40 gallons (100 to 200 litres) will require two sets of UTMK. We do not recommend you use UTMK on tanks larger than 40 gallons, in this case we recommend you contact your local blacksmith to make suitable fixing brackets.

**UTMK** Universal tank mounting kit has 4.5 mtr of coated pre punched banding with kit of fasteners to attach tank.

**UTS** Roll of punched banding strap only 4.5 mtr.

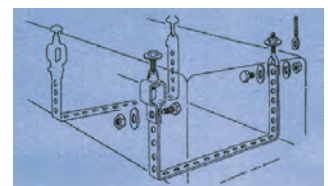

**OPTIONAL 5" RED ACCESS CAP or 4" MALE THREADED CAP**

A fully sealed access cap THCAP5 or THCAP4 can be supplied as an option with this tank at a further charge (see price list) Tanks can be installed with the cap facing upwards or downwards. **PLEASE NOTE** provision of a RRC red cap will increase height of tank by 40mm (1 1/2"). Tanks with FRC or MTC are designed for cap to be at top of tank because cap is recessed, but can be used with cap at base. But you would not be able to use cap for full drainage. Please bear this in mind when ordering.

**CAP OPTION CAN ONLY BE FITTED TO TANKS MARKED FRC, RRC OR MTC AT TIME OF MANUFACTURE.**

**RRC** Raised red cap. THCAP5 Increases height measurement of tank by 40mm (1 1/2")

**FRC** Flush red cap. THCAP5 As this is flush fitted it does not increase tank height measurement.

**MTC** Male threaded cap THCAP4 As this is flush fitted it does not increase tank height measurement.

**TANKS IN SIZE ORDER BY LONGEST SIZE.**  
**WE CAN PUT CONNECTION FITTINGS IN TO SUIT REQUIREMENTS.**  
**WE DO NOT MAKE TANKS TO SPECIFIC SIZES.**  
**SIZES AND CAPACITIES APPROXIMATE.® C.A.K. TANKS DESIGN RIGHT**  
**WE NOW OFFER INSTALLATION & REPAIR SERVICE BY [SupremeTech.co.uk](http://SupremeTech.co.uk)**



# TANKS ORDERING INFORMATION

(Please read before going any further)



## VEHICLE APPLICATIONS LISTING FOR C.A.K. TANKS

(Catalogue Page Number for Tank Drawing is shown in RED)

VEHICLE MAKE	TANK CODE & NAME (KIT TYPE)	APPROXIMATE FITTING POSITION (PLEASE MEASURE)
CITROEN C25	084 SEVEL (F) – 68 lit (11)	AT REAR BEHIND AXLE
TALBOT EXPRESS	065 VILLA (W) – 34 lit (13)	IN CENTRE IN FRONT OF REAR AXLE
FIAT DUCATO 1 & 2 UP TO 94		
CITROEN RELAY TO 01	123 BOXER (F) – 59 lit (11)	EXTERNALLY BELOW PASSENGER SEAT
PEUGEOT BOXER TO 01	121 RELAY (W) – 39 lit (13)	IN CENTRE IN FRONT OF REAR AXLE
FIAT DUCATO 3 / 94 TO 01		
CITROEN RELAY 01 – 06	123 BOXER (F) ALL – 59 lit (11)	EXTERNALLY BELOW PASSENGER SEAT
PEUGEOT BOXER 01 – 06	194 DUCATO (W) ALL – 39 lit (13)	IN CENTRE IN FRONT OF REAR AXLE
FIAT DUCATO 4 / 01 – 06	197 C197 (F) LWB ONLY – 59 lit (11)	CENTRE & SIDE IN FRONT OF N/S REAR WHEEL
CITROEN RELAY 06 ON (X250)	223 (F) MWB & LWB – 66 lit (8)	N/S BETWEEN CHASSIS & HANDBRAKE ROD
PEUGEOT BOXER 06 ON (X250)	233 (F) XLWB ONLY – 91 lit (7)	N/S BETWEEN CHASSIS & HANDBRAKE ROD
FIAT DUCATO 5 / 06 ON (X250)	224 (W) MWB & LWB – 50 lit (11)	O/S BETWEEN CHASSIS & HANDBRAKE ROD
	223 (W) XLWB ONLY – 66 lit (8)	O/S BETWEEN CHASSIS & HANDBRAKE ROD
PEUGEOT EXPERT 2007 ON	229 – (F) EXPERT – 40 lit (12)	(APPROX BETWEEN CHASSIS & EXHAUST)
CITROEN DISPATCH 2007 ON	230 (W) DESPATCH – 21 lit (11)	(APPROX BETWEEN CHASSIS & EXHAUST)
FIAT SCUDO 2007 ON	232 – (F) SCUDO FRESH – 29 lit (13)	(APPROX BETWEEN CHASSIS & EXHAUST)
	231 – (W) SCUDO WASTE – 19.5 lit (14)	(APPROX BETWEEN CHASSIS & EXHAUST)
FORD TRANSIT 86 to 91	088 N G T TANK (F) – 50 lit (12)	O/S BEHIND DRIVERS STEP
FORD TRANSIT 91 ON - SWB	088 N G T TANK (F) – 50 lit (12)	O/S BEHIND DRIVERS STEP
	086 BB5 (W) – 18 lit (15)	N/S BEHIND FUEL TANK
FORD TRANSIT 91ON - LWB	088 N G T TANK (F) – 50 lit (12)	O/S BEHIND DRIVERS STEP
	078 HB13 / 082 SB12 (W) – 52/50 lit (9 / 9)	N/S BEHIND FUEL TANK
TRANSIT 2001 ON – SWB FWD	190 TRANSIT 2000 (F) – 54 lit (8)	O/S BEHIND DRIVERS STEP
	191 OR 192 (W) – 30 lit (12 / 15)	N/S TOWARDS REAR HALF OF STEP & CHASSIS
TRANSIT 2001 ON - MWB RWD	045 MERC 307 (F) – 50 lit (9)	O/S BEHIND DRIVERS STEP
	(W)	
TRANSIT 2001 ON – LWB RWD	126 DART (F) – 68 lit (8)	O/S BEHIND DRIVERS STEP
	061 A10 (W) – 36 lit (10)	N/S BEHIND FUEL TANK
LDV CONVOY (PEUGEOT ENG)	137 TRENT (F) – 73 lit (8)	O/S BEHIND DRIVERS STEP (CHECK EXHAUST)
(FORD ENGINE)	126 DART (F) – 68 lit (8)	O/S BEHIND DRIVERS STEP (CHECK LENGTH)
	020 WAFER (W) – 36 lit (16)	
LDV PILOT/ 200	014 LEYLAND/ SHERPA (F) – 64 lit (11)	O/S BEHIND DRIVERS STEP
MERC 207/8 307/8/10 407/8 PRE 95	045 MERC 307 (F) – 50 lit (9)	OPPOSITE POSITION TO FUEL TANK
SPRINTER/ NEW LT - PETROL	154 SPRINT PETROL (F) – 50 lit (7)	O/S BEHIND & BELOW DRIVERS STEP
SPRINTER/ NEW LT - DIESEL	148 SPRINT DIESEL (F) – 54 lit (10)	O/S BEHIND DRIVERS STEP
	149 MBSW (W) – 29 lit (13)	N/S BEHIND FUEL TANK
NEW SPRINTER / CRAFTER (Approx 2005 onwards)	(F) 045 MERC-50 lit (9) / 126 DART-68 lit (8)	
	(W) 088 NGT-50 lit (12)/ 065 VILLA-34 lit (13)	
RENAULT TRAFFIC	063 A13 (F) – 50 lit (9)	N/S UNDER SIDE DOOR FLOOR
VAUXHALL ARENA	035 MK II VW SM (W) – 32 lit (8)	CENTRALLY MOUNTED
RENAULT NEW TRAFFIC 07/01 ON	209 TRAFFIC – 48 lit (11)	CENTRALLY BEHIND FUEL TANK
VAUXHALL VIVARO	208 VIVARO – 36 lit (11)	CENTRALLY IN FRONT OF FUEL TANK BELOW CAB FLOOR
	210 VIVARO SKIRT – 20 lit (14)	N/S UNDER SKIRT
RENAULT MASTER 99 TO 2009 ON	193 MOVANO (F) MWB & LWB – 81 lit (11)	CENTRE IN FRONT OF REAR AXLE
VAUXHALL MOVANO TO 2009	221 MASTER (W) – 36 lit (12)	BETWEEN FRESH TANK 193 & IN FRONT OF AXLE
	065 VILLA (W) – 34 lit (13)	BEHIND AXLE
VW OLD LT TO 96	022 VW LT FRESH – 68 lit (13)	O/S BEHIND DRIVERS FRONT JACK POINT
	021 VW LT WASTE – 54 lit (15)	O/S FOLLOWS ON BEHIND FRESH
VW T2S 80 TO 90	045 MERC 307 (F) – 50 lit (9)	N/S BEHIND SKIRT UNDER SLIDING DOOR
	065 VILLA (W) – 34 lit (13)	O/S BEHIND SKIRT
VW T4 (Approx 1990 onwards)	079 T4 TANK (F) – 74 lit (11)	CENTRALLY TO REAR OF FUEL TANK
	096 VISION (W) – 31 lit (10)	BELOW SLIDING DOOR STEP
VW T5 (Approx 2003 onwards)	204 T5 STEP – 27 lit (14)	TWIN TANKS O/S UNDER DRIVERS STEP & SKIRT
	205 SKIRT TANK (F) – 21 lit (12)	
	203 T5 WASTE (W) – 38 lit (14)	CENTRE REAR IN FRONT OF SPARE WHEEL NOT SYNCHRO.
	206 / 214 T5 INTERNAL (F) – 42/32 lit (12)	DESIGNED TO FIT UP TO AND OVER REAR WHEEL ARCH

THIS LIST IS NOT EXHAUSTIVE; MANY OTHER TANKS WILL FIT IN OTHER POSITIONS. THIS MAY SUIT YOUR CONVERSION BETTER. ABOVE LIST IS FOR GUIDANCE ONLY. PLEASE MEASURE TO ENSURE THE TANK YOU ORDER WILL FIT YOUR VEHICLE AS MANY VEHICLES ARE MODIFIED FROM STANDARD, OR, MANUFACTURERS MAKE BASE VEHICLE CHANGES IN PRODUCTION.

WE NOW OFFER INSTALLATION & REPAIR SERVICE BY [SupremeTech.co.uk](http://SupremeTech.co.uk)

## THERMOTANK RANGE

Special fully insulated underfloor water tanks. Over five years of design refinement and testing have provided the ultimate water tank. Double skinned & foam insulated with all connections on top to come up through the floor. The tanks are installed with four bolts through the floor rails.

141 – MKI THERMOTANK 16 GALL / 73 LIT			151 – MKII THERMOTANK 13 GALL / 60 LIT			188 – MKIII THERMOTANK 16 GALL / 72 LIT		
Length	Width	Height	Length	Width	Height	Length	Width	Height
43" 1090	25" 636	6 3/4" 170	40" 1015	25 5/8" 600	6 7/8" 175	33 1/2" 850	18 1/4" 465	11" 280

## C.A.K. POLYETHYLENE TANKS

We design, develop and manufacture an extensive range of storage tanks from 1 to 97 gallons, suitable for drinking water, waste & toilet discharge. Our tanks are moulded in black polyethylene to the highest specifications for drinking water use. They are one piece seam free mouldings for long term reliability & in black to prevent the growth of algae which causes bad tastes which can occur in white or clear containers. All hose connections can be plastic welded in to suit the individual requirements at no extra charge to ensure a trouble free product to meet our fix and forget reputation providing tanks of unprecedented quality and reliability. Comprehensive water supply fixing kits to suit most vehicles are available on request to ensure a trouble free installation. C.A.K. Tanks are patented, with anti-surge baffles built into most tanks.

<b>039 – STATIC</b> 67 GALL / 304 LIT 			<b>114 – HWW</b> 62 GALL / 282 LIT 			<b>154 – SPRINTER PETROL</b> 11 GALL / 50 LIT 			<b>233 – X250 XL FRESH</b> 20 GALL / 91 LIT 		
Length	Width	Height	Length	Width	Height	Length	Width	Height	Length	Width	Height
71 1/2" 1816	35 1/2" 902	8" 204	67" 1700	20" 510	13 3/4" 350	58 1/2" 1488	13" 330	5 1/2" 140	56 1/4" 1430	16 3/8" 415	8" 203
<b>168 – THAMES</b> 36 GALL / 164 LIT 			<b>186 – KIELDER</b> 55 GALL / 251 LIT 			<b>112 – HFW</b> 74 GALL / 336 LIT 			<b>180 – DERWENT</b> 93 GALL / 423 LIT 		
Length	Width	Height	Length	Width	Height	Length	Width	Height	Length	Width	Height
53 1/2" 1360	25 1/2" 650	8" 200	53 1/2" 1360	25 1/2" 650	11 3/4" 300	53 1/2" 1360	25 1/2" 650	15 3/4" 400	53 1/2" 1360	25 1/2" 650	19 5/8" 500
<b>143 – ECON</b> 66 GALL / 300 LIT 			<b>098 - CANARD</b> 19 GALL / 85 LIT 			<b>034 – MKII VW LARGE</b> 11 GALL / 52 LIT 			<p style="text-align: center;"><b>TANKS IN SIZE ORDER BY LONGEST SIZE.</b>  <b>WE CAN PUT CONNECTION FITTINGS IN TO SUIT REQUIREMENTS.</b>  <b>WE DO NOT MAKE TANKS TO SPECIFIC SIZES.</b>  <b>SIZES AND CAPACITIES APPROXIMATE.</b>  <small>© C.A.K. TANKS DESIGN RIGHT</small></p>		
Length	Width	Height	Length	Width	Height	Length	Width	Height			
52" 1320	24 3/4" 630	22" 560	48 3/4" 1240	17 1/8" 435	6 5/8" 168	48.7" 1238	12" 305	5 3/4" 146			

WE NOW OFFER INSTALLATION & REPAIR SERVICE BY [SupremeTech.co.uk](http://SupremeTech.co.uk)



0844 414 2324



0844 414 2425



<b>129 - Q4</b> 23 GALL / 109 LIT			<b>062 - DELTA</b> 35 GALL / 159 LIT			<b>058 - A20</b> 22 GALL / 100 LIT			<b>076 - HB80</b> 80 GALL / 363 LIT		
Length	Width	Height	Length	Width	Height	Length	Width	Height	Length	Width	Height
48" 1219	12" 305	12" 305	48" 1219	17" 431	13" 330	48" 1219	21 3/4" 552	6" 152	47 1/2" 1210	39" 995	11 1/2" 295
<b>137 - TRENT</b> 16 GALL / 73 LIT			<b>091 - PLT</b> 23 GALL / 105 LIT			<b>013 - SLIMLINE</b> 7 GALL / 31 LIT			<b>132 - GILLETTE</b> 15 1/4 GALL / 69 LIT		
Length	Width	Height	Length	Width	Height	Length	Width	Height	Length	Width	Height
47" 1194	15" 381	7" 177	46" 1169	31 1/2" 800	6 1/2" 165	46" 1168	7 1/2" 191	6 1/2" 165	46" 1168	31 1/2" 800	3 1/2" 89
<b>126 - DART</b> 15 GALL / 68 LIT			<b>035 - MKII VW SMALL</b> 7 GALL / 32 LIT			<b>042 - HB25</b> 28 GALL / 127 LIT			<b>142 - SANDWICH</b> 9 GALL / 41 LIT		
Length	Width	Height	Length	Width	Height	Length	Width	Height	Length	Width	Height
45 3/8" 1152	12" 305	8 1/2" 216	45.2" 1149	8 1/2" 216	5 3/4" 146	45" 1143	21" 533	9" 228	44 1/2" 1130	25" 635	2 5/8" 67
<b>190 - TRANSIT 2000 SWB</b> FWD 12 GALL / 54 LIT			<b>223 - X250 LWB FRESH</b> 14 GALL / 66 LIT			<b>184 - CONISTON</b> 32 GALL / 145 LIT			<b>125 - HF2</b> 66 GALL / 300 LIT		
Length	Width	Height	Length	Width	Height	Length	Width	Height	Length	Width	Height
44" 1120	13" 330	7 1/2" 185	43 3/4" 1110	13 3/8" 340	8" 203	43 1/4" 1100	35" 900	6 1/2" 165	43 1/4" 1100	35" 900	13" 340
<b>200 - NENE</b> 20 GALL / 92 LIT			<b>179 - AVON</b> 29.5 GALL / 134 LIT			<b>029 - 40" SLIMLINE</b> 6 GALL / 27 LIT			<p style="text-align: center;"> <b>TANKS IN SIZE ORDER BY LONGEST SIZE.</b>  <b>WE CAN PUT CONNECTION FITTINGS IN TO SUIT REQUIREMENTS.</b>  <b>WE DO NOT MAKE TANKS TO SPECIFIC SIZES.</b>  <b>SIZES AND CAPACITIES APPROXIMATE.</b>  <small>© C.A.K. TANKS DESIGN RIGHT</small> </p>		
Length	Width	Height	Length	Width	Height	Length	Width	Height			
41 3/4" 1060	17 3/8" 440	7 3/4" 197	41" 1040	21 5/8" 550	10 1/2" 265	40" 1018	7 1/2" 191	6 1/2" 165			

WE NOW OFFER INSTALLATION & REPAIR SERVICE BY [SupremeTech.co.uk](http://SupremeTech.co.uk)

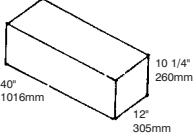
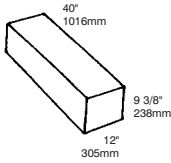
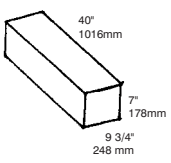
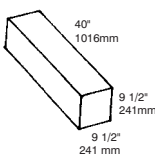
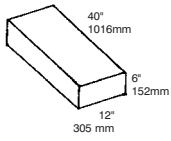
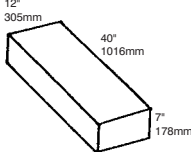
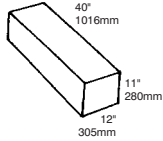
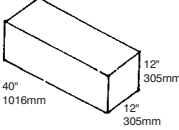
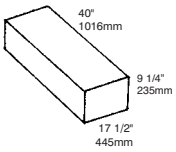
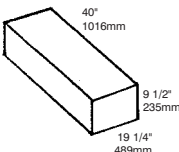
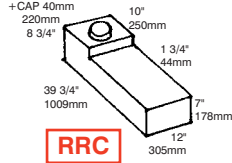
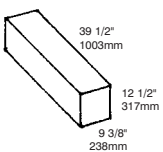
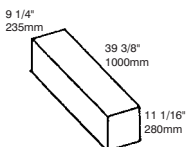
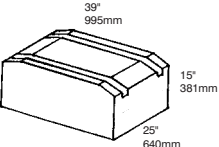
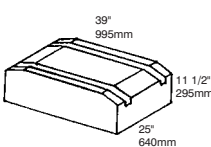
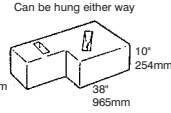
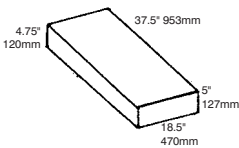
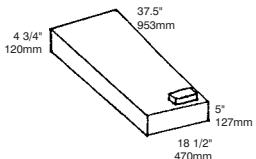
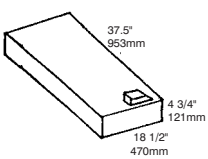
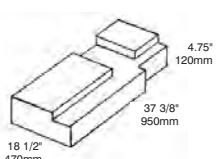

<b>199 – LT307</b> <b>16 GALL / 73 LIT</b> 			<b>201 – 407 TANK</b> <b>14 GALL / 64 LIT</b> 			<b>195 – HIACE</b> <b>9 GALL / 41 LIT</b> 			<b>070 – C70</b> <b>12 GALL / 52 LIT</b> 		
Length	Width	Height	Length	Width	Height	Length	Width	Height	Length	Width	Height
40" 1016	12" 305	10 1/4" 260	40" 1016	12" 305	9 3/8" 238	40" 1016	9 3/4" 248	7" 178	40" 1016	9 1/2" 241	9 1/2" 241
<b>074 – TOWBAR</b> <b>9 GALL / 41 LIT</b> 			<b>045 – 307 MERC</b> <b>11 GALL / 50 LIT</b> 			<b>106 – MT307</b> <b>17 GALL / 77 LIT</b> 			<b>072 – HI-TOP 307</b> <b>19 GALL / 86 LIT</b> 		
Length	Width	Height	Length	Width	Height	Length	Width	Height	Length	Width	Height
40" 1016	12" 305	6" 152	40" 1016	12" 305	7" 178	40" 1016	12" 305	11" 280	40" 1016	12" 305	12" 305
<b>080 – C80</b> <b>22 GALL / 100 LIT</b> 			<b>090 – C90</b> <b>24 GALL / 109 LIT</b> 			<b>145 – CAMEO</b> <b>13 GALL / 59 LIT</b> 			<b>100 – C100</b> <b>16 GALL / 68 LIT</b> 		
Length	Width	Height	Length	Width	Height	Length	Width	Height	Length	Width	Height
40" 1016	17 1/2" 445	9 1/4" 235	40" 1016	19 1/4" 489	9 1/2" 235	39 3/4" 1009	12" 305	8 3/4" 220	39 1/2" 1003	9 3/8" 238	12 1/2" 317
<b>093 – C93</b> <b>13 GALL / 59 LIT</b> 			<b>218 – HB50</b> <b>53 GALL / 240 LIT</b> 			<b>075 – HB40</b> <b>38 GALL / 172 LIT</b> 			<b>024 – LHD ROYALTY</b> <b>19 GALL / 86 LIT</b> 		
Length	Width	Height	Length	Width	Height	Length	Width	Height	Length	Width	Height
39 3/8" 1000	9 1/4" 235	11 1/16" 280	39" 995	25" 640	15" 381	39" 995	25" 640	11 1/2" 295	38" 965	16" 406	10" 254
<b>063 – A13</b> <b>11 GALL / 50 LIT</b> 			<b>078 – HB13</b> <b>11 GALL / 50 LIT</b> 			<b>082 – SB12</b> <b>10 GALL / 45 LIT</b> 			<b>228 – TRANSIT 2007 NS FRESH</b> <b>16 GALL / 72 LIT</b> 		
Length	Width	Height	Length	Width	Height	Length	Width	Height	Length	Width	Height
37 1/2" 953	18 1/2" 470	5" 127	37 1/2" 953	18 1/2" 470	5" 127	37 1/2" 953	18 1/2" 470	4 3/4" 121	37 3/8" 950	18 1/2" 470	4 3/4" 120

WE NOW OFFER INSTALLATION & REPAIR SERVICE BY [SupremeTech.co.uk](http://SupremeTech.co.uk)



0844 414 2324



0844 414 2425



<b>061 - A10</b> <b>8 GALL / 36 LIT</b>			<b>096 - VISION</b> <b>6.8 GALL / 31 LIT</b>			<b>128 - A16</b> <b>17 GALL / 77 LIT</b>			<b>189 - MKIII SANDWICH</b> <b>6 GALL / 27 LIT</b>		
Length	Width	Height	Length	Width	Height	Length	Width	Height	Length	Width	Height
37" 940	15 1/2" 394	4 1/4" 108	36 3/4" 933	12 1/8" 308	5" 127	36 1/4" 921	19 1/2" 490	7 1/8" 181	36 1/4" 921	19 1/2" 495	3" 76
<b>207 - HT SIERRA</b> <b>44 GALL / 200 LIT</b>			<b>211 - MT SIERRA</b> <b>36 GALL / 166 LIT</b>			<b>073 - SIERRA</b> <b>29 GALL / 132 LIT</b>			<b>133 - PICO</b> <b>17 GALL / 77 LIT</b>		
Length	Width	Height	Length	Width	Height	Length	Width	Height	Length	Width	Height
36" 915	20" 508	18" 457	36" 915	20" 508	15" 381	36" 915	20" 508	12" 305	36" 915	12" 305	12" 305
<b>202 - C202</b> <b>16 GALL / 73 LIT</b>			<b>175 - STOUR</b> <b>20 GALL / 91 LIT</b>			<b>092 - DRIFTER LARGE</b> <b>22 GALL / 100 LIT</b>			<b>139 - VSG139</b> <b>22 GALL / 100 LIT</b>		
Length	Width	Height	Length	Width	Height	Length	Width	Height	Length	Width	Height
36" 910	14 1/8" 360	9 1/2" 240	35 1/2" 900	24 3/4" 630	7 1/8" 181	35 1/2" 900	23 1/2" 600	9" 230	35 1/2" 900	15 3/4" 400	11" 280
<b>147 - AT147</b> <b>18 GALL / 84 LIT</b>			<b>122 - EXPORT LHD BOXER</b> <b>15 GALL / 68 LIT</b>			<b>127 - JAVELIN</b> <b>24 GALL / 109 LIT</b>			<b>159 - 570 SCL</b> <b>12 GALL / 55 LIT</b>		
Length	Width	Height	Length	Width	Height	Length	Width	Height	Length	Width	Height
35" 890	15 3/4" 400	11" 285	35" 890	15 3/4" 400	10 1/2" 263	34 5/8" 880	19 1/2" 490	10 1/2" 265	34 5/8" 880	19 1/2" 490	7" 178
<b>227 - GRASMERE</b> <b>64 GALL / 290 LIT</b>			<b>140 - ECON 200</b> <b>44 GALL / 200 LIT</b>			<b>136 - AXOR</b> <b>35 GALL / 159 LIT</b>			<b>148 - SPRINTER DIESEL</b> <b>12 GALL / 54 LIT</b>		
Length	Width	Height	Length	Width	Height	Length	Width	Height	Length	Width	Height
34 1/2" 885	24 3/4" 630	24" 610	34 1/2" 880	24 3/4" 630	22" 560	34 1/2" 876	19 1/4" 489	16" 406	34 1/2" 876	10 1/2" 268	10 1/2" 268

WE NOW OFFER INSTALLATION & REPAIR SERVICE BY [SupremeTech.co.uk](http://SupremeTech.co.uk)



<b>196 – RUTLAND</b> <b>12 ½ GALL / 56 LIT</b>			<b>208 – VIVARO</b> <b>8 GALL / 36 LIT</b>			<b>032 – 34" SLIMLINE</b> <b>5 GALL / 22 LIT</b>			<b>224 – X250 LWB WASTE</b> <b>11 GALL / 50 LIT</b>		
Length	Width	Height	Length	Width	Height	Length	Width	Height	Length	Width	Height
34 1/8" 867	12 3/4" 324	9 1/4" 234	34" 863	7" 178	11" 280	34" 863	6 1/2" 165	7 1/2" 190	33 7/8" 860	13 3/8" 340	8" 203
<b>123 – BOXER</b> <b>13 GALL / 59 LIT</b>			<b>108 – MT SEVEL</b> <b>18 GALL / 80 LIT</b>			<b>084 – SEVEL</b> <b>15 GALL / 68 LIT</b>			<b>079 – T4</b> <b>16 GALL / 74 LIT</b>		
Length	Width	Height	Length	Width	Height	Length	Width	Height	Length	Width	Height
33" 840	18" 460	9 1/2" 241	32 5/8" 829	15 3/4" 400	10 1/2" 268	32 5/8" 829	15 3/4" 400	9" 229	32" 820	23 1/2" 600	6" 155
<b>185 – BELAIR</b> <b>24 GALL / 109 LIT</b>			<b>197 – C197</b> <b>13 GALL / 59 LIT</b>			<b>023 – MOONRAKER</b> <b>8 GALL / 36 LIT</b>			<b>046 – 400R</b> <b>24 GALL / 109 LIT</b>		
Length	Width	Height	Length	Width	Height	Length	Width	Height	Length	Width	Height
32 1/8" 815	17 3/4" 450	13 3/8" 340	32 1/8" 815	18 3/4" 474	10 5/8" 270	32" 813	18" 406	5" 127	32" 812	26" 661	8 3/4" 222
<b>209 – TRAFFIC</b> <b>10 ½ GALL / 48 LIT</b>			<b>077 – CALYPSO CHUBBY</b> <b>12 GALL / 55 LIT</b>			<b>181 – HUMBER</b> <b>24 ½ GALL / 112 LIT</b>			<b>095 – DRIFTER II</b> <b>19 GALL / 88 LIT</b>		
Length	Width	Height	Length	Width	Height	Length	Width	Height	Length	Width	Height
32" 813	13" 330	9" 229	32" 812	13" 330	9" 230	31 7/8" 810	19 1/2" 495	12 3/4" 323	31 3/4" 810	23 3/4" 605	7 1/2" 195
<b>030 – AMIGO</b> <b>11 GALL / 50 LIT</b>			<b>014 – LEYLAND SHERPA</b> <b>14 GALL / 64 LIT</b>			<b>193 – MOVANO</b> 18 GALL / 81 LIT			<b>230 - DESPATCH</b> <b>4 ½ GALL / 21 LIT</b>		
Length	Width	Height	Length	Width	Height	Length	Width	Height	Length	Width	Height
31 1/2" 800	18" 457	6" 152	31 3/8" 804	15 1/2" 394	8 1/2" 216	24" 608	31" 800	6 1/4" 170	31" 790	13 1/4" 340	6 1/4" 160

WE NOW OFFER INSTALLATION & REPAIR SERVICE BY [SupremeTech.co.uk](http://SupremeTech.co.uk)



0844 414 2324



0844 414 2425



Water Tanks

Buy securely online at [Leisurelines.net](http://Leisurelines.net)

**104 - TREBLE SEVEN**  
25-30 GALL / -- LIT

**153 - ARROW**  
18 GALL / 82 LIT

**164 - SWALLOW**  
18 GALL / 82 LIT

**094 - MIRAGE**  
6 GALL / 27 LIT

Length	Width	Height
30 3/4"	21"	20 3/4"
782	533	529

Length	Width	Height
30 3/4"	16 1/2"	10 1/2"
780	420	268

Length	Width	Height
30 3/4"	16 1/2"	10 1/2"
780	420	268

Length	Width	Height
30 1/4"	13 1/4"	5"
768	335	127

**221 - MASTER TANK**  
8 GALL / 36 LIT

**007 - 14 GAL TRANSIT**  
14 GALL / 63 LIT

**071 - LANDROVER**  
24 GALL / 109 LIT

**088 - NGT**  
11 GALL / 50 LIT

Length	Width	Height
30 1/4"	9 1/4"	8"
770	237	204

Length	Width	Height
30"	15 1/2"	9 1/2"
762	394	241

Length	Width	Height
31 1/4"	15"	19 5/8"
790	280	498

Length	Width	Height
30"	13"	9"
762	330	229

**191 - C191**  
6.5 GALL / 30 LIT

**205 - T5 SKIRT TANK**  
4 1/2 GALL / 21 LIT

**171 - WEAR**  
11 GALL / 50 LIT

**156 - C156**  
32 GALL / 145 LIT

Length	Width	Height
30"	13"	7"
762	330	178

Length	Width	Height
30 1/2"	9 1/8"	7"
775	232	178

Length	Width	Height
29 3/4"	23 1/2"	4 3/4"
756	597	121

Length	Width	Height
28 3/4"	21 1/4"	17"
730	540	433

**182- C182**  
14 GALL / 64 LIT

**229 - EXPERT**  
8 3/4 GALL / 40 LIT

**166 - SPEY**  
12 1/2 GALL / 57 LIT

**165 - TYNE**  
17 GALL / 77 LIT

Length	Width	Height
28"	21 1/2"	7 1/4"
711	546	186

Length	Width	Height
28"	20 1/4"	6 1/4"
711	515	160

Length	Width	Height
27 3/4"	15 5/8"	10"
705	397	254

Length	Width	Height
27 1/2"	15 5/8"	12"
700	397	305

**206 - T5 WHEEL ARCH**  
9 GALL / 42 LIT

**214- T5 LOW ARCH**  
7 GALL / 32 LIT

**187 - VITO**  
11 GALL / 49 LIT

**069 - BIG MAC**  
34 GALL / 154 LIT

Length	Width	Height
27 1/2"	9 5/8"	18 7/8"
700	245	480

Length	Width	Height
27 1/2"	9 5/8"	16"
700	245	405

Length	Width	Height
27"	24"	5 5/16"
686	610	135

Length	Width	Height
27 1/4"	21 5/8"	19"
690	550	480

WE NOW OFFER INSTALLATION & REPAIR SERVICE BY [SupremeTech.co.uk](http://SupremeTech.co.uk)

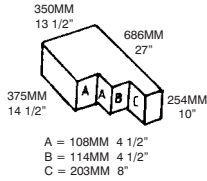
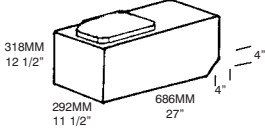
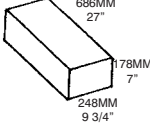
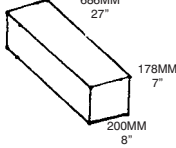
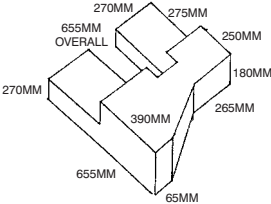
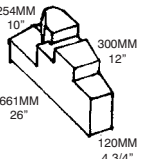
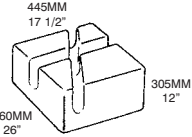
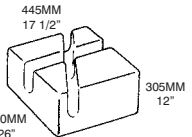
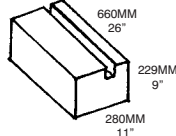
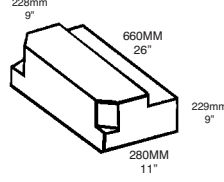
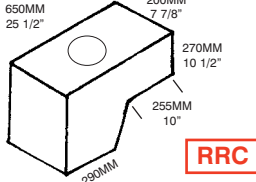
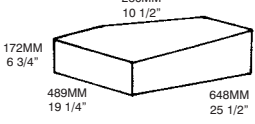
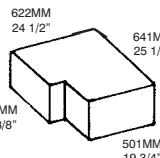
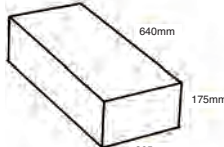
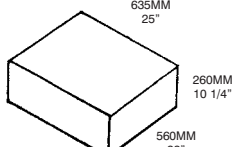
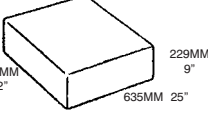
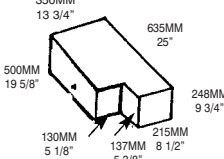
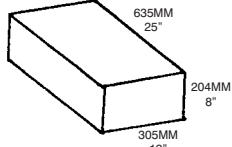
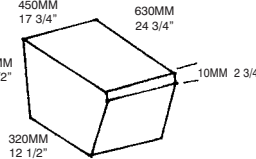
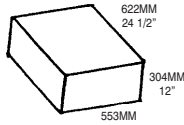
<b>050 – CB5</b> <b>9 GALL / 41 LIT</b> 			<b>052 – CB8</b> <b>13 GALL / 59 LIT</b> 			<b>089 – TOYOTA</b> <b>6 GALL / 27 LIT</b> 			<b>167 – PENTARA</b> <b>4 1/2 GALL / 20 LIT</b> 		
Length	Width	Height	Length	Width	Height	Length	Width	Height	Length	Width	Height
27" 686	13 1/2" 350	10" 254	27" 686	11 1/2" 292	12 1/2" 318	27" 686	9 3/4" 248	7" 178	27" 686	8" 200	7" 178
<b>157 – SADDLE TANK</b> <b>11 GALL / 49 LIT Approx</b> 			<b>149 - MBSW</b> <b>6 GALL / 29 LIT</b> 			<b>022 – VW OLD LT RHD</b> <b>15 GALL / 68 LIT</b> 			<b>044 – VW OLD LT LHD</b> <b>15 GALL / 68 LIT</b> 		
Length	Width	Height	Length	Width	Height	Length	Width	Height	Length	Width	Height
26 3/16" 665	25 3/4" 655	7" 180	26" 661	12" 300	10" 254	26" 660	17 1/2" 445	12" 305	26" 660	17 1/2" 445	12" 305
<b>121 – RELAY</b> <b>8 1/2 GALL / 39 LIT</b> 			<b>194 – DUCATO</b> <b>8 1/2 GALL / 39 LIT</b> 			<b>134 – BOXER ARCH</b> <b>12 GALL / 56 LIT</b> 			<b>105 – SLANT</b> <b>12 GALL / 55 LIT</b> 		
Length	Width	Height	Length	Width	Height	Length	Width	Height	Length	Width	Height
26" 660	11" 280	9" 229	26" 660	11" 280	9" 229	25 1/2" 650	7 7/8" 200	25 1/2" 648	25 1/2" 648	19 1/4" 489	6 3/4" 172
<b>150 – C150</b> <b>19 GALL / 86 LIT</b> 			<b>232 – SCUDO FRESH</b> <b>6 GALL / 29 LIT</b> 			<b>115 – MK.II HI-TOP</b> <b>18 1/2 GALL / 84 LIT</b> 			<b>025 – MK.II TRANSIT</b> <b>16 GALL / 73 LIT</b> 		
Length	Width	Height	Length	Width	Height	Length	Width	Height	Length	Width	Height
25 1/4" 641	24 1/2" 622	9 1/2" 240	25" 640	12" 305	7" 175	25" 635	22" 560	10 1/4" 260	25" 635	22" 560	9" 229
<b>051 – CB6</b> <b>10 GALL / 45 LIT</b> 			<b>065 – VILLA</b> <b>7 1/2 GALL / 34 LIT</b> 			<b>113– HTD</b> <b>28 GALL / 127 LIT</b> 			<b>087 – MK.II SUPATOP</b> <b>21 GALL / 95 LIT</b> 		
Length	Width	Height	Length	Width	Height	Length	Width	Height	Length	Width	Height
25" 635	13 3/4" 350	9 3/4" 248	25" 635	12" 305	8" 204	24 3/4" 630	17 3/4" 450	22 1/2" 570	24 1/2" 622	21 3/4" 553	12" 304

WE NOW OFFER INSTALLATION & REPAIR SERVICE BY [SupremeTech.co.uk](http://SupremeTech.co.uk)



0844 414 2324



0844 414 2425



<b>131 – HERALD 131</b> <b>16 GALL / 73 LIT</b> 			<b>130 – C130</b> <b>12 GALL / 54 LIT</b> 			<b>203 – T5 WASTE</b> <b>8 GALL / 38 LIT</b> 			<b>225 - VIANO</b> <b>4 1/2 GALL / 21 LIT</b> 		
Length	Width	Height	Length	Width	Height	Length	Width	Height	Length	Width	Height
24 1/2" 622	21 1/2" 546	9" 229	24 1/2" 622	21 3/4" 552	7" 178	24 1/2" 623	17 1/2" 445	10" 255	24" 610	10" 254	11 1/4" 285
<b>160 – C160</b> <b>13 GALL / 59 LIT</b> 			<b>111 - HDW</b> <b>17 GALL / 77 LIT</b> 			<b>110 – PANORAMIC</b> <b>12 GALL / 54 LIT</b> 			<b>216 – T300</b> <b>25 GALL / 113 LIT</b> 		
Length	Width	Height	Length	Width	Height	Length	Width	Height	Length	Width	Height
23 5/8" 600	21 1/8" 537	8" 203	23 1/2" 600	20" 510	11" 280	23 1/2" 600	20" 510	8" 200	23 1/2" 600	18" 457	18" 457
<b>068 – T200</b> <b>21 GALL / 95 LIT</b> 			<b>217 – T120</b> <b>17 GALL / 77 LIT</b> 			<b>031 – T100</b> <b>13 GALL / 59 LIT</b> 			<b>177 – TEES</b> <b>11 GALL / 50 LIT</b> 		
Length	Width	Height	Length	Width	Height	Length	Width	Height	Length	Width	Height
23 1/2" 600	18" 457	15" 380	23 1/2" 600	18" 457	12 1/8" 308	23 1/2" 598	17 3/4" 453	9 1/2" 241	23 1/4" 590	19 3/8" 492	7 3/4" 197
<b>231 – SCUDO WASTE</b> <b>4 1/2 GALL / 19 LIT</b> 			<b>220 – SPRINTAWAY</b> <b>5 GALL / 23 LIT</b> 			<b>172 – SCUDO</b> <b>8 GALL / 32 LIT</b> 			<b>210 – VIVARO SKIRT</b> <b>4 1/2 GALL / 19 1/2 LIT</b> 		
Length	Width	Height	Length	Width	Height	Length	Width	Height	Length	Width	Height
23" 585	11 1/2" 295	9" 228	22 7/8" 580	10" 255	6 7/8" 175	23" 584	12" 305	8" 204	23" 585	9" 229	7" 178
<b>178 – CONWAY</b> <b>34 GALL / 155 LIT</b> 			<b>173 – FAIRWAY</b> <b>28 1/2 GALL / 130 LIT</b> 			<b>174– HIGHLAND</b> <b>28 1/2 GALL / 130 LIT</b> 			<b>204 – T5 STEP TANK</b> <b>6 GALL / 27 LIT</b> 		
Length	Width	Height	Length	Width	Height	Length	Width	Height	Length	Width	Height
22 5/8" 575	22 5/8" 575	18" 455	22 5/8" 575	22 5/8" 575	17 3/4" 452	22 5/8" 575	22 5/8" 575	17" 433	22 1/4" 564	12" 305	9" 230

WE NOW OFFER INSTALLATION & REPAIR SERVICE BY [SupremeTech.co.uk](http://SupremeTech.co.uk)

<b>213 – TEMPEST</b> <b>4 GALL / 18 LIT</b>			<b>119 – ESO</b> <b>15 GALL / 68 LIT</b>			<b>170 – MENAI</b> <b>6 ½ GALL / 30 LIT</b>			<b>222 – ROTHER</b> <b>21 GALL / 96 LIT</b>		
Length	Width	Height	Length	Width	Height	Length	Width	Height	Length	Width	Height
22"	7 7/8"	7 1/8"	21 ¾"	15 ¾"	11 ¾"	21 ¾"	15 ¾"	6"	21 ½"	17 ¾"	18 ¾"
560	200	180	550	400	300	550	400	150	545	450	475
<b>176 – C176</b> <b>10 ½ GALL / 48 LIT</b>			<b>235 – BAILEY UPGRADE</b> <b>8 ¾ GALL / 40 LIT</b>			<b>021 – OLD VW LT WASTE</b> <b>12 GALL / 54 LIT</b>			<b>192 – C192</b> <b>6 ½ GALL / 30 LIT</b>		
Length	Width	Height	Length	Width	Height	Length	Width	Height	Length	Width	Height
20 5/8"	20"	8"	20 ½"	13"	10 ½"	20 ½"	17 ½"	12 ½"	20 ½"	13"	8"
525	506	204	523	330	267	521	445	318	521	330	204
<b>099 – CENTURION</b> <b>10 GALL / 45 LIT</b>			<b>037 – 280L</b> <b>7 GALL / 31 LIT</b>			<b>144 – 140L</b> <b>3 GALL / 13 LIT</b>			<b>155 – C155</b> <b>22 GALL / 100 LIT</b>		
Length	Width	Height	Length	Width	Height	Length	Width	Height	Length	Width	Height
20 ½"	13"	16"	20 ½"	13"	8"	20 ½"	13"	4"	20 ½"	19 7/8"	16"
521	330	407	521	330	203	521	330	102	520	505	405
<b>120 – BUCCANEER</b> <b>9 ½ GALL / 47 LIT</b>			<b>036 – 280S</b> <b>6 GALL / 27 LIT</b>			<b>162 – C162</b> <b>8 ¾ GALL / 40 LIT</b>			<b>169 – FREEWAY</b> <b>24 GALL / 108 LIT</b>		
Length	Width	Height	Length	Width	Height	Length	Width	Height	Length	Width	Height
20"	17 7/8"	10 ½"	20"	9 5/8"	9"	19 ¾"	16 ½"	8"	19 5/8"	18 7/8"	19 ¼"
508	454	267	508	247	229	500	415	205	500	480	490
<b>183 – TWEED</b> <b>4.3 GALL / 19 ½ LIT</b>			<b>086 – BB5</b> <b>4 GALL / 18 LIT</b>			<b>083 – BAMBINO</b> <b>3 ½ GALL / 16 LIT</b>			<b>085 – BB2</b> <b>2 GALL / 9 LIT</b>		
Length	Width	Height	Length	Width	Height	Length	Width	Height	Length	Width	Height
19 1/5"	11"	6 ¾"	19"	10 ½"	6 ½"	19"	6 ½"	9"	19"	6"	6 ½"
487	280	172	483	268	165	483	165	229	483	152	165

WE NOW OFFER INSTALLATION & REPAIR SERVICE BY [SupremeTech.co.uk](http://SupremeTech.co.uk)



0844 414 2324



0844 414 2425



<b>124 – CONQUEROR</b> 9 GALL / 41 LIT			<b>138 – SPECTRUM</b> 7 1/2 GALL / 34 LIT			<b>064 – HI TOP WAFER</b> 16 GALL / 72 LIT			<b>020 – WAFER</b> 8 GALL / 36 LIT		
Length	Width	Height	Length	Width	Height	Length	Width	Height	Length	Width	Height
19" 480	13 1/2" 336	11 3/4" 300	19" 480	11 3/4" 300	11" 280	18" 457	18" 457	14 3/4" 374	18" 457	18" 457	7 1/2" 191
<b>097 – SEVEL SEAT BOX</b> 10 GALL / 45 LIT			<b>226 – RIB SEAT</b> 8 GALL / 37 LIT			<b>163 – C163</b> 6 GALL / 27 LIT			<b>067 – ALPHA</b> 9 GALL / 41 LIT		
Length	Width	Height	Length	Width	Height	Length	Width	Height	Length	Width	Height
16 1/4" 415	14" 360	13" 330	17 1/4" 432	16 1/4" 413	10" 250	16 3/8" 415	14 1/8" 360	8" 205	16" 407	14" 356	12" 305
<b>117 – TORNADO</b> 2 1/2 GALL / 11 LIT			<b>219 – T5 4-MOTION</b> 3 GALL / 15 LIT			<b>146 – HURRICANE</b> 3 GALL / 15 LIT			<b>198 – TYPHOON</b> 2 GALL / 9 LIT		
Length	Width	Height	Length	Width	Height	Length	Width	Height	Length	Width	Height
16" 407	5" 127	10" 254	15 1/8" 385	7 3/4" 196	10 1/2" 270	13 1/4" 340	10 1/4" 260	7 1/4" 185	12 5/8" 320	5 1/4" 134	9 5/8" 245
<b>161 – C161</b> 3 GALL / 14 LIT			<b>081 – C81</b> 3 GALL / 14 LIT			<b>158 – BREAKAWAY</b> 3 GALL / 15 LIT			<b>038 – 250 HE</b> 3 1/2 GALL / 16 LIT		
Length	Width	Height	Length	Width	Height	Length	Width	Height	Length	Width	Height
12 3/4" 320	12 5/8" 325	6 1/2" 165	12 3/8" 314	10 3/4" 273	11 1/2" 292	12" 305	11 1/4" 285	9 1/4" 233	12" 305	10" 254	9" 229
<b>135 – 250T</b> 2 GALL / 9 LIT			<b>103 – 25 LIT CHURN</b> 			<b>102 – 40 LIT CHURN</b> 			<p style="color: red; text-align: center;"> <b>TANKS IN SIZE ORDER BY LONGEST SIZE.</b>  <b>WE CAN PUT CONNECTION FITTINGS IN TO SUIT REQUIREMENTS.</b>  <b>WE DO NOT MAKE TANKS TO SPECIFIC SIZES.</b>  <b>SIZES AND CAPACITIES APPROXIMATE.</b>  <small>© C.A.K. TANKS DESIGN RIGHT</small> </p>		
Length	Width	Height	Length	Width	Height	Length	Width	Height			
12" 305	10" 250	5 1/2" 143	N/A	13" 330	17" 432	N/A	13" 330	24" 610			

WE NOW OFFER INSTALLATION & REPAIR SERVICE BY [SupremeTech.co.uk](http://SupremeTech.co.uk)



## OPTIONAL 5" RED ACCESS CAP or 4" MALE THREADED CAP FOR TANKS ON PAGES 7 TO 16

A fully sealed access cap THCAP5 or THCAP4 can be supplied as an option with this tank at a further charge (see price list) Tanks can be installed with the cap facing upwards or downwards. **PLEASE NOTE** provision of a RRC red cap will increase height of tank by 40mm ( 1 1/2"). Tanks with FRC or MTC are designed for cap to be at top of tank because cap is recessed, but can be used with cap at base. But you would not be able to use cap for full drainage. Please bear this in mind when ordering. **CAP OPTION CAN ONLY BE FITTED TO TANKS MARKED FRC, RRC OR MTC AT TIME OF MANUFACTURE.**

- RRC** Raised red cap. THCAP5 Increases height measurement of tank by 40mm (1 1/2")
- FRC** Flush red cap. THCAP5 As this is flush fitted it does not increase tank height measurement.
- MTC** Male threaded cap THCAP4 As this is flush fitted it does not increase tank height measurement.



## C.A.K. TANK MOUNTING HOOK BOLTS

Hook bolts are used to mount our tanks with brackets to the underside of your Motorhome or Camper. Supplied with nuts.

- HB3** 80mm 3" HOOK BOLT
- HB4** 110mm 4" HOOK BOLT (standard size used in our kits)
- HB5** 130mm 5" HOOK BOLT
- HB6** 150mm 6" HOOK BOLT
- HB7** 180mm 7" HOOK BOLT
- HB8** 200mm 8" HOOK BOLT
- HB9** 220mm 9" HOOK BOLT

HOOK BOLTS RANGE

## PORTABLE WATER AND WASTE CONTAINERS

**WWC20** Black plastic 19 Litre portable waste tank with 100mm filling cap in top. Size H 435 x W 290 x D 165mm

Opaque plastic water containers with secure 100mm screw cap & built in handle. FWC10 has 3/4" BSP sealed threaded hole on face below cap. Sizes H x W x D mm FWC10T H 350 x W 190 x D 235mm, FWC10Q H 230 x W 225 x D 300mm

- FWC10T** 10 Litre H 350 x W 190 x D 235mm
- FWC10Q** 10 Litre with sealed threaded outlet hole H 230 x W 225 x D 300mm



WWC20



FWC10T



FWC10Q

## SHURFLO PRESSURE REGULATED MAINS WATER INLET

A pressure regulated connection for external wall mounting to permit direct mains water supply connection at a restricted pressure of 30psi. An exclusive diaphragm design prevents high-pressure damage to the water system components caused by high pressure mains water systems. Leak-tight, stress and crack-resistant, these high-performance water entries limit water pressure safely while meeting or surpassing all check valve regulations. As installed by Avondale. Colour Gel White. 1 year warranty.

- SFCTW30W** Shurflo city water inlet housing 30psi
- SFCTWCON** Straight adaptor for Shurflo city water inlet

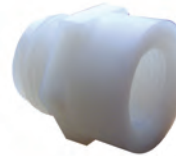

SFCTWCON



SFCTW30W

## AQUA TANK WATER TANKS - - TANKS PLAIN AND SIMPLE

Aqua Tank Systems plain light blue plastic water tanks with secure screw cap or threaded hatch access port. Suitable for Fresh or Waste water. Great product – Great price. No connections on tanks. Just add nut-in fittings (see page 24) to suit your connection needs.

Sizes L x W x H mm. Access port: C= 5" CAP, CR= Raised 5" CAP + 40mm to height, H = 4" HATCH

- ATS155** 155 litre water tank 575 x 575 x 455mm C
- ATS113** 113 litre water tank 812 x 661 x 222mm H
- ATS109** 109 litre water tank 880 x 490 x 265mm C
- ATS092** 92 litre water tank 1060 x 440 x 197mm H
- ATS083** 82 litre water tank 921 x 490 x 181mm CR
- ATS082** 82 litre water tank 780 x 420 x 268mm C
- ATS081** 81 litre water tank 915 x 305 x 305mm CR
- ATS073** 73 litre water tank 622 x 546 x 229mm C
- ATS068** 68 litre water tank 550 x 400 x 300mm C
- ATS064** 64 litre water tank 598 x 453 x 241mm H
- ATS056** 56 litre water tank 867 x 324 x 234mm H
- ATS054** 55 litre water tank 812 x 330 x 230mm H
- ATS042** 41 litre water tank 407 x 356 x 305mm H
- ATS036** 36 litre water tank 457 x 457 x 191mm H
- ATS034** 34 litre water tank 635 x 305 x 204mm H
- ATS031** 31 litre water tank 521 x 330 x 203mm H
- ATS016** 16 litre water tank 305 x 254 x 229mm H





### 9 10 & 19 LITRE WATER CONTAINERS

Opaque plastic water containers with secure screw cap & built in handle. FWC10 Tap supplied loose to fit into in sealed threaded hole. FWC20 suitable for use with submersible pumps. Sizes L x W x H mm FWC10 280 x 165 x 300mm, FWC20 330 x 210 x 430mm.

- FWC10** 10 litre water container with tap
- FWC20** 19 litre water container with 100mm cap

**FWC9** This easily portable water container is suitable for filling an existing system or for use in the smaller portable water application. Dimensions H 260mm x W 120mm x L 420mm. Capacity 9 Litres. With 100mm cap and 3/4" BSP Female plugged outlet.

**WWC20S** Portable slide under waste tank with 100mm filling cap in side. Can be used with optional WWTHOSE. Sizes L x W x H mm 435 x 290 x 165mm

### WATER TAXI 25 LITRE WHEELED FRESH & WASTE WATER TANKS

Both fresh and waste water taxi's hold 25litres. They are easily pulled along with the foldable handle, large wheels make the movement a straight forward job. Both tanks have a large handle in the middle to aid manoeuvring.

Sizes: Handle extended 840mm Handle closed 490mm x 340W x 250mm H

### FRESH WATER TAXI 25 LITRE

Our fresh water taxi is coloured Blue for identification. It comes with a DIN 61 cap near the top to act as a filling point and also a vent when laid down for emptying. Large DIN 96 access cap allows submersible pumps to be placed inside to empty contents. There is a position on the tank to store spare access cap (can be cut open to make extra access).

- FWT25** Fresh water taxi 25 litre Blue
- FWT10100** Spare DIN 96 cap.

### WASTE WATER TAXI 25 LITRE

Our waste water taxi is coloured Black for waste water identification. It has a DIN 61 cap near the top to act as a vent when stood up for emptying. A pretty useful system for transporting waste water to the on site disposal point. To empty, simply unscrew large cap and tip up into drain.

- WWT25** Waste water taxi 25 litre grey with 1m x 28mm connecting hose and cap.
- WWTHOSE** 1 metre of 25mm supaflex hose attached to a spare cap to aid connection to drain tap for filling

### 70 LITRE WATER TANK

Blow moulded 70 litre tank with 2 screw caps, a large 170 access cap on top and threaded port at base of end. Ideal for mounting in the bed box, within double floor or in the spare space in motorhome garage. Dimensions: 940L x 370W x 260H

- FWT70** 70 LITRE WATER TANK

### 35 LITRE FRESH & WASTE WATER TAXI

New addition to our Water Taxi range the 35 litre Aquamobile. Designed with underchassis mounting kit in mind for easy storage. The Aquamobile has one large 145mm access cap in the centre for inspection and cleaning, the smaller 45mm apertures with threaded caps for filling and draining an one 1/2" cap at the handle end. Size approximately 80 x 36 x 17 cm, Weight 5 kg.

- WWTAK35G** Aquamobile Grey 35litre fresh water taxi
- WWTAK35K** Aquamobile Black 35litre waste water taxi

### UNDER CHASSIS CARRIER FOR 35 LITRE WATER TAXI

The under chassis carrier is designed specifically for our 35litre Aquamobile no other tank will fit. Manufactured from steel tube zinc plated for all weather protection. The mounting kit is universal for any chassis and fitted without drilling any holes into the chassis. It can be fitted to be accessed from the left or right hand side. The mounting kit is supplied boxed with all components for assembly and fitting to the chassis. Designed to be installed to the rear of the axle, clear of the brake cables, on BPW / ALKO or similar Caravan & Motorhome chassis. Check you have sufficient clear floor area to install before setting out to install carrier.

- WWTAKMTK** Under Chassis mounting kit for 35litre Aquamobile



**PS1049 FOLDING TRAVEL BUCKET.**  
Approx dimensions 300mm high x 215mm Ø



**PSWC05** Five litre collapsible water carrier



**PSWC10** 10 Litre collapsible water carrier



**PSWC20** 20 Litre collapsible water carrier



**FWC10 AND 20**



**FWC9**



**FWT25**



**WWC20S**



**FWT70**



**WWT25 SHOWN WITH OPTIONAL WWTHOSE**



**WWTHOSE**

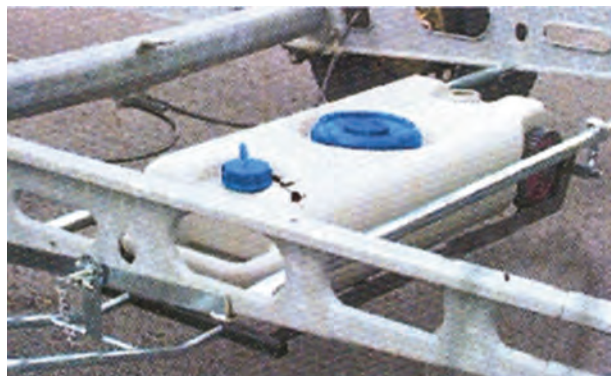

WE NOW OFFER INSTALLATION & REPAIR SERVICE BY [SupremeTech.co.uk](http://SupremeTech.co.uk)



## WATER FILLERS (flush fitting nylon) (for 40mm hose)

Manufactured from high quality impact resistant non-toxic Nylon. Pre-drilled for easy installation. The water fillers have short stems suitable for C.A.K. 40mm Supaflex hose & a 10mm connection for tank vent.

Our fillers are fitted as standard on most manufacturers vehicles.

- F20SHORT** ROUND BLACK NYLON FILLER & LOCKING CAP - B
- F23SHORT** ROUND WHITE NYLON FILLER & LOCKING CAP- A
- F20FCL** SPARE F20 / 21 LOCKING CAP BLACK
- F23FCL** SPARE F23 / EZF LOCKING CAP WHITE

## DIESEL FILLERS (for 60mm, 50mm & 40 mm hose)

- F20D40L** ROUND LONG STEM BLACK DIESEL 40mm & 60mm - E
- F20D50L** ROUND LONG STEM BLACK DIESEL 50mm & 60mm - D
- F23D50L** ROUND LONG STEM WHITE DIESEL 50mm & 60mm - F

## ALL PLASTIC FILLER (for 40mm hose)

- FAP1** ALL PLASTIC SCREW CAP FILLER WITH BACKNUT TO NUT THRU-WALL. BLACK CAP WHITE FILLER. (40 mm HOSE) - C

## WATER FILLERS FABRICATED (Black nylon coated)

Hand fabricated to our traditional standards. Hot dipped Rilsan Black Nylon coated for Corrosion protection & a pleasing appearance. Add L to end of code for locking version.

- F1** LEYLAND FILLER NON LOCK (25 mm hose)
- F2** COMMER FILLER NON LOCK (25 mm hose)
- F6** FLUSH FIT TANK FILLER 25mm high NON LOCK
- F7** THRU CORNER 45 DEG TANK FILLER NON LOCK
- FC** SPARE NON LOCK FILLER CAP
- FCL** SPARE LOCKING FILLER CAP

## DRINKING WATER AND WASTE STICKERS

Text printed in three languages, English, French & German. Helps to prevent accidental filling of water tank with fuel. (Yes it does happen quite often).

- DWO** DRINKING WATER ONLY STICKER
- WDS** WASTE DRAIN POINT STICKER

## COMPACT SUPAFLOT CASSETTE HOSE FOR DRINKING WATER

- DRINKING WATER SAFE
- DURABLE CONSTRUCTION
- EASY TO USE
- COMPACT CASSETTE SIZE

Durable and lightweight our lay flat cassette hose is manufactured with high-grade polyester reinforced PVC in a special formulation containing low temperature stabilisers and a natural low toxic inner. The material used to produce the hose is to F & D.A. \*\* food approved material standards, to ensure it is suitable for drinking water. (\*\* F&D.A. (USA Federal Food & Drug Administration), and United Kingdom Food & Drug Statutory Instrument 1980 no. 1838 specification ensure the product is well suited to potable liquid applications). Supaflot hose assumes a conventional round appearance under pressure, and its memory for a flat profile ensures self-draining. The hose is supplied in a cassette, with a handle for easy re-winding. Much quicker and easier to use, than untangling a usual roll of PVC hose, also taking up much less precious storage space. Please do not confuse this product with similar cassette hoses. We have used a standard off the shelf cassette but assembled the cassette hose with a very high quality food grade Supaflat hose to ensure taint free usage. Size 371mm diameter, just 40mm thin (62mm with handle). Please note garden hose is not food quality & should not be used for filling water tanks.

- DWC15** Compact shorter 15 m Supaflat cassette hose
- DWC20** Compact longer 20 m Supaflat cassette hose

- DWC15BL** 15M Compact Tri-flow cassette hose. Water will flow regardless of how much hose is unwound.



**F80RW** Rectangular water filler used on some UK and Continental Motorhomes. Sizes W158 x H136mm

**NEW** water filler with locking cap housed behind snap shut cover. **F30SHORT** White **F31SHORT** Black Sizes 137mm High x 122mm Wide. Cut out oval 90mm High x 85mm Wide.

**NEW** mains inlet connection in matching style to water filler. **MIF30** White **MIF31** Black. (See P95)

**NEW** Fuel filler with locking cap housed behind snap shut cover. **F30 LONG D** White

**FILLMATE** NEW filling cap with snap fit connection in centre of cap. Suitable for externally vented tanks.

**FILLMATEBLU** for tanks vented back to filler point.



**NEW MWI6097** mains water inlet Pressure limiter reduces mains water pressure to prevent damage to internal piping and equipment installed. Fits universal snap fit hozelock/gardena hose connections. Connection water system is by 12mm push fit female connection. Can be used to fill tanks. Comes with air vents to release excess air during filling hole cut out 60mm diameter.



**NEW F7441** white recessed water filler with key locking door and screw cap access to fill water. Cut out hole dia approx 118mm. Flange size H150mm x W155mm 40mm hose connection. Left hand hinged.



**NEW F320B** Water filler with hinged lid closing fill point, horizontal or vertical mounting possible with rotatable rear 40mm hose connection for all sides. Cut out hole size 115 x 85mm approx Flange size H160mm x W 130mm.

## NYLON FLUSH FITTING RECESSED FILLERS



## FABRICATED STEEL FILLERS

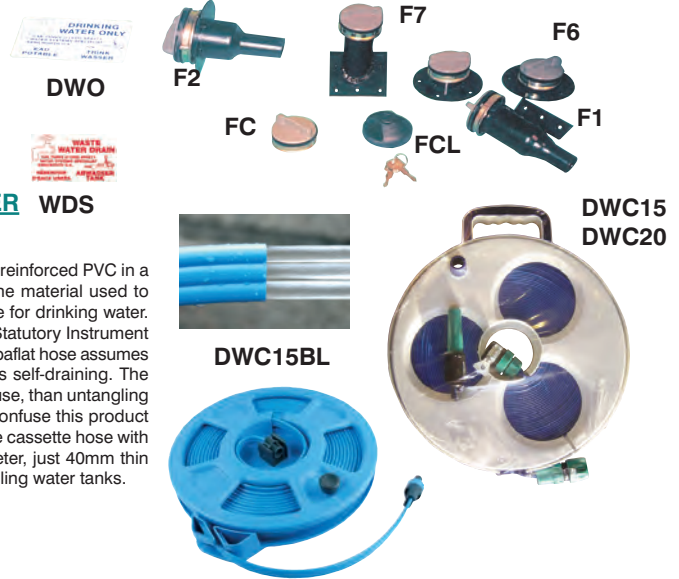

WE NOW OFFER INSTALLATION & REPAIR SERVICE BY [SupremeTech.co.uk](http://SupremeTech.co.uk)



0844 414 2324



0844 414 2425



# DE-FROST ELEMENTS, TANK WRAP, LAYFLAT & RIGID WASTE SYSTEM



Water Tanks - Accessories

Buy securely online at Leisurelines.net

## TANK DE-FROST ELEMENT

Designed to reduce the chance of stored water freezing up by warming the water sufficiently to prevent freezing up of tank. The stainless element is simply installed by nutting through side wall of tank 55mm (2 1/8") up from base, preferably near pump outlet. Without additional insulation the element alone should prevent 45 litres of water freezing at temperatures down to -25°C. Larger capacities may need additional insulation of tank to protect to this level (Tank wrap & Styrofoam). To save battery power consumption, use tank insulation wrap to reduce heat loss from tank walls. This will make the element's job easier and will therefore be on for reduced times saving a lot of power, while providing much better protection.

We recommend illuminated on / off switches are installed with both elements to confirm power is off as their work is not visible. Both elements are powered by 12 volts DC supply at 30 watts and consume 2.5 amps. Use CBE MC12N/G switch see page 88. Suitable for plastic and metal tanks but not fuel tanks.

DFE-01 manually switched de-frost element is fitted to larger Systems to supplement the DFE-02 during very cold weather. When additional protection is required, it is simply switched on. Stainless element size: DFE-01 115 mm long x 15 mm dia.

DFE-02 has inbuilt automatic thermostats, turning it on at 5°C and off at 10°C. Stainless element size: DFE-02 200 mm long x 18 mm dia.

- DFE-01** Manually switched De-frost element.
- DFE-02** Automatic De-frost element + thermostats.
- DFE-06** Retrofit Stainless mounting plate for DFE-01 and DFE-02

## TANK INSULATING WRAP

Aluminized thermally reflective multi-layer air entrapped Insulating wrap. Provides very effective thermal protection for underslung tanks. When used in conjunction with De-frost Elements it provides the ultimate protection. Simply wrap tank like a Christmas present, securing insulation with grey extra strong securing tape, to provide a very effective tank insulating Jacket. Supplied per metre on a roll width of 1200 mm

- BXTX12** BXTX12 insulating wrap 1200mm (48") wide per linear metre.
- BXGST** Grey extra strong securing tape for tank wrap.
- BXGSTALI** Aluminium foil tape for securing wrap 50mm

## INSPECTION, FILLING AND ACCESS CAPS

For the simplest system an underseat tank can be filled through the hatch for ease of installation. The standard Hatch we use is the **THSO4**. This comes with an 'O' ring seal and can be fitted to the top of almost any tank. **THSO4** or **QTH4** **CANNOT** be fitted to the side or bottom of tanks. A growing number of our tanks are featuring our fully sealed 5" red cap (4) **THCAP5** to aid inspection and installation of extra equipment such as tank de-frost elements. The **THCAP5** cap can only be fitted to tanks marked **RRC** or **FRC**. The **THCAP4** (6) can only be fitted to tanks marked **MTC**

Inspection hatches and access caps can be fitted to tanks at time of production. (No extra installation charge only cost of the item fitted)

- 1 QTH4** 4" Budget inspection hatch 1/4 turn black
- 2 THSO4** 4" inspection hatch threaded with 'o' ring Our standard Hatch
- 3 THSO10** 10" threaded captive ring hatch fully sealed (7" access hole)
- 4 THCAP5** 5" Red cap for tanks sealed with 'o' ring for **RRC FRC** Tanks
- 6 THCAP4** Male threaded cap **ONLY** for tanks marked **MTC**
- 5 THCAP3** 3" spare blue cap for tanks sealed with 'o' ring (4" access)

## NEW SUPAFLAT LAYFLAT DISCHARGE HOSE

A GREAT NEW SPACE SAVING PRODUCT. Supafat discharge hose is Blue reinforced lay flat hose made from two layers of PVC and bonded to a close woven textile reinforcement. Pressure ratings given are at ambient temperature. The hose is used for all general discharge duties with any of our tank drains & slide valve hose connections. Not for use with fresh water

- H2FL** 25MM LAY FLAT DISCHARGE HOSE Per linear metre.
- H4FL** 40MM LAY FLAT DISCHARGE HOSE Per linear metre.
- H7FL** 75MM LAY FLAT DISCHARGE HOSE Per linear metre.

## 40MM RIGID WASTE TUBING - (32mm range also available)

New 40mm drain piping system which also allows the installation of 1 1/2" slide valves and Ultradrain taps remotely away from the tank. Pipe and fittings can be assembled easily using normal solvent pipe cement. **Pipe sold per mtr. Max length for carrier despatch 1.5mtr. Maximum Single length 5mtr (Collection only)**

- RW40P** 40MM PIPE per 1mtr length
- RW40STR** 40MM STRAIGHT CONNECTOR (B)
- RW40ANG** 40MM 45 DEG ANGLED CONNECTOR (A)
- RW40ELB** 40MM 90 DEG ELBOW CONNECTOR (C)
- RW40TEE** 40MM TEE CONNECTOR (D)
- RW40TEE45** 40MM TEE 45 DEGREE OUTLET CONNECTOR (E)
- RW5040RSKT** REDUCING SOCKET 50MALE /40FEMALE x 40mm FEMALE (F)
- RW50FADTH1H** 50mm FEMALE ADAPTOR x 1 1/2" FEMALE BSP (G)
- RW40FADTH1Q** 40mm FEMALE ADAPTOR x 1 1/4" FEMALE BSP (G)
- RW40UNTH1Q** 40 mm JOINER UNION x 1 1/4" FEMALE BSP (H)
- RW50M40FRD** REDUCER BUSH 50mm MALE x 40mm FEMALE (J)
- RW40F1QM** 40mm FEMALE ADAPTOR x 1 1/4" MALE BSP (K)
- RW401QNUTIN** 40mm FEMALE ADAPTOR NUT IN FITTING (L)

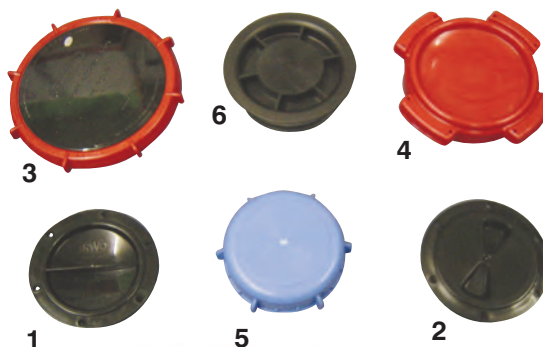
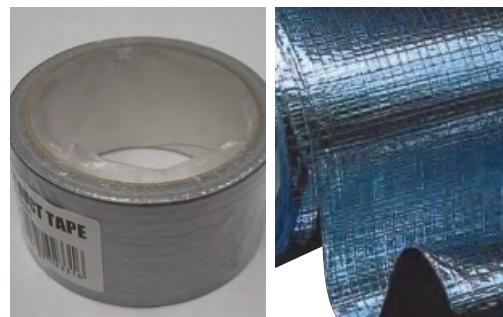
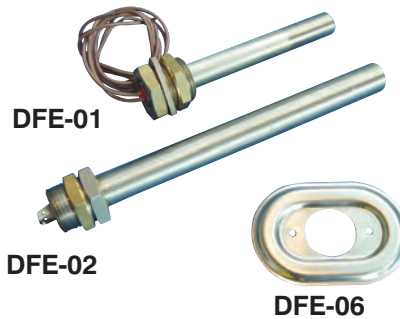

WE NOW OFFER INSTALLATION SERVICE IN KENILWORTH BY [SupremeTech.co.uk](http://SupremeTech.co.uk)



# EASYDRAIN, SOLENOID, SUPADRAIN, ULTRADRAIN AND MEGADRAIN VALVES



## EASYDRAIN ELECTRO VALVES

Our motorised ball valves are designed for easy operation at the flick of a switch of wastewater drain points and other valve applications. High quality construction for strength and long-term reliability, our easydrain valve can be retrofitted using various hose or adapter fittings into almost any installation. All have female threaded ports for installation of hose connections or adaptors. The EDV075 is the most popular valve for retrofitting. When installed with our straight hose fitting STR100, EDV075 is easily fitted into the industry standard 1" supaflex drain hose as used by most manufacturers. The valve has a thermal overload protection of 1 amp. All easy drain valves work on a voltage of 12 volts DC only.

CODE	THREAD SIZE	MAX. CURRENT 12 VOLT
EDV050	1/2 INCH BSP	0.8 AMP
EDV075	3/4 INCH BSP	0.8 AMP
EDV100	1 INCH BSP	1 AMP
EDV125	1 1/4 INCH BSP	1 AMP
EDVMSW	MOMENTARY TWO WAY ROCKER CONTROL SWITCH	

## SMALL BORE SOLENOID VALVES

All plastic solenoid valves for electro control of fresh water circuits, BSP female threads, very useful for toilet flush control or easy change over of water system. With adaptors can be used on any water piping system. Cold water only. Marine spec valves are double actuation.

MSV12M	SOLENOID VALVE 12 VOLT, 3/8" BSP THREAD	
MSV24M	SOLENOID VALVE 24 VOLT, 3/8" BSP THREAD	
MSV12L	SOLENOID VALVE 12 VOLT, 1/2" BSP THREAD MARINE SPEC	
MSV24L	SOLENOID VALVE 24 VOLT, 1/2" BSP THREAD MARINE SPEC	

## SUPADRAIN FRESH & WASTE TAPS WITH EASY CONNECT BAYONET HOSE

A	STR100	1" STRAIGHT HOSE ADAPTOR 3/4" BSP THREAD
	ELB100	1" ELBOW HOSE ADAPTOR 3/4" BSP THREAD
B	SDT075M	1" METAL SUPATAP 3/4" BSP FEMALE THREADS
C	HFQB075	3/4" BSP THREAD + BAYONET QUICK CONNECTOR
D	HFQBH075	3/4" HOSE BARB + BAYONET QUICK CONNECTOR

- FASTER DRAINING BALL VALVE
- EASY CONNECT BAYONET
- QUICK OPERATION
- NO NEED TO PARK RIGHT ON DISPOSAL POINT
- WILL NOT CLOG
- EASIER THAN THREADS
- EASY DIY RETROFIT

The supadrain tap is a 3/4" clear bore large ball valve providing significantly quicker emptying times, while also ensuring blockages are a thing of the past. The bayonet connectors provide a convenient way to add an extension hose to your waste drain point. You do not need to spend time with careful maneuvering to get close to the drain point, simply with a twist add on an extension hose (use H3SB or H3SG 3/4" supaflex hose) to reach straight away. It's so easy you can do it in the dark without fumbling!! The bayonet parts will also interchange to provide hose extensions. The supadrain tap is easily retrofitted to all installations where 1" remote drain pipes come from tank. Just remove existing tap and refit our new tap into end of hose with a jubilee clip. Can also be installed, using a 1" nut in elbow fitting, on the base access caps of certain waste tank designs to fully drain the existing installation.

## NEW PRESSURE WASHER GARDEN QUICK CONNECT FOR VALVES

New STRGDN... pressure washer quick connectors for Valves are produced from nylon or solid brass. Male 1/2" garden quick connect male to BSP male thread.

STRGDN050M	1/2" QK Con x 1/2" BSP male fitting
STRGDN075MB	1/2" QK Con x 3/4" BSP male brass fitting
STRGDN100M	1/2" QK Con x 1" BSP male fitting

## MEGADRAIN TAP

Our extra large drain valve for the bigger capacity tank (not toilet waste). Significantly larger bore than our ever-popular Supadrain tap, the Megadrain tap will never clog up on grey waste. Vastly reduced emptying times of grey waste tank, large lever on valve makes opening valve quite easy. Megadrain connects to tank with 40mm supaflex hose and connectors, various quick disconnect hose adaptors make connecting extension hoses quick and easy. Metal components are stainless steel.

A	MDT040	40mm MEGADRAIN TAP 1 1/4" BSP FEMALE THREADED
	ELB40MT	1 1/4" BSP X 40mm HOSE BARB ELBOW HOSE FITTING
B	STR40MT	1 1/4" BSP X 40mm HOSE BARB STRAIGHT HOSE FITTING
C	QCFT	QUICK CONNECTOR FEMALE X 1 1/4" BSP MALE
D	QCM40	QUICK CONNECTOR MALE X 40mm HOSE BARB
E	QCF40	QUICK CONNECTOR FEMALE X 40mm HOSE BARB
F	QCMCAP	QUICK CONNECTOR MALE STOP END PLUG
G	QCLS	SAFETY LOCKING CLIP FOR QUICK CONN ARMS

## ULTRADRAIN VALVE

New 40mm drain valve system for inboard waste tank. Quick emptying due to larger size valve. Kit complete with 2 sections of rigid piping (295 & 455mm), one elbow, one 135 degree end nozzle, 1 x valve, one 2 metre extension hose & one extension handle 80mm min 480mm Max. Fix to tank using a SV151 male adaptor, or 40mm supaflex hose from a 40mm fitting on tank. This system is fitted to Hymer, Burstner and numerous other german manufactured motorhomes.

UDTKIT	ULTRADRAIN TAP & PIPE KIT (A+B)
UDTXH	EXTENSION HOSE 2 METRE FOR ULTRADRAIN TAP (B)
UDTXH1M	EXTENSION HOSE 1METER FOR ULTRADRAIN TAP

WE NOW OFFER INSTALLATION & REPAIR SERVICE BY [SupremeTech.co.uk](http://SupremeTech.co.uk)

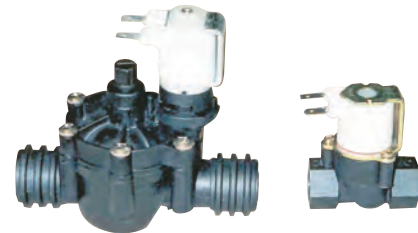
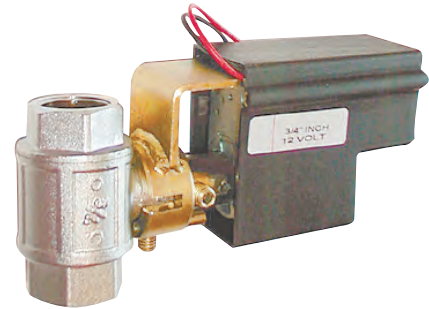

MSV12L

MSV12M

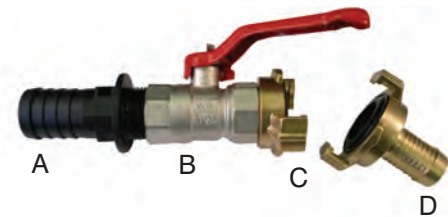

A

B

C

D



STRGDN075MB

STRGDN050M

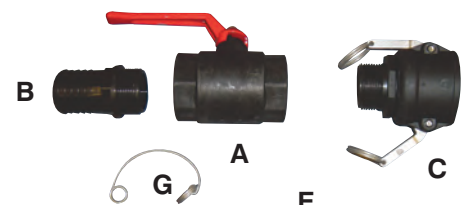

B

A

C

D

G

E

F

D

D

D

D

A

A

A

A

A

A

A

A

A

A

A

A

A

A

A

A

A

A

A

A

A

A

ULTRADRAIN

A

A

A

A

A

A

A

A

A

A

A

A

A

A

A

A

A

A

A

B



0844 414 2324



0844 414 2425



# SLIDE VALVES



Water Tanks - Accessories

## ELECTRIC SLIDE VALVE ACTUATOR KITS

Electric actuator kit is easily fitted to our slide valves. Kit clamps onto valves for easy remote control of 3" and 1.5" slide drain valves. High specification long life design for trouble free operation. Can be retrofitted to existing installations as a diy job. New installations require suitable slide valve, not supplied (either SV150S or SV300C see below). Power supply 12v dc versions only, valve open to closed stroke time up to 6 seconds, max. Current at end of stroke 1.2 amp, operating current 0.4 - 0.6 amp, thermally protected overload, max. push pull force 20 kgf, life 30,000 operations, actuator functioning ambient temperature -30°C to +85°C. In freezing temperatures water may need anti freeze liquids or defrost elements to protect valve.

- ESVA158 ELECTRO ACTUATOR FOR SV150 1.5" SLIDE VALVE 12 VOLT
- ESVA301 ELECTRO ACTUATOR FOR SV300 3.0" SLIDE VALVE 12 VOLT

## 1 1/2" WASTE TANK SLIDE DRAIN VALVES

Fixed to fresh or grey waste tanks for quick emptying. Just pull on handle to open the blade valve. Installed by fixing tank adaptor flange (use SV152) to tank with large self-tapping screws or bolts sealed with silicone sealant. Valve can be fixed to adaptor by solvent cement (plumbing glue) in a position to suit easy access for emptying. Can be installed remotely from tank with 40mm inlet adaptor & 40mm supaflex hose. Outlet extension hose can easily be connected with bayonet hose adaptor. Made from impact resistant black ABS with nitrile and EPDM seals.

- SV150S 1 1/2" SLIDE VALVE SHORT HANDLE WITH CAP
- SV150L 1 1/2" SLIDE VALVE LONG HANDLE WITH CAP
- SV150X 1 1/2" SLIDE VALVE FOR EXTENSION HANDLE (SVXH...) WITH CAP
- SV151 1 1/2" MALE ADAPTOR FLANGE
- SV152 1 1/2" FEMALE TANK ADAPTOR + LANYARD LUG
- SV156 1 1/2" BAYONET STRAIGHT HOSE ADAPTOR 40MM HOSE
- SV153 1 1/2" MALE BAYONET VALVE CONNECTION
- SV154 1 1/2" BAYONET CAP + LANYARD
- SV155 1 1/2" BLADE SEAL
- SV157 1 1/2" PLAIN FLANGE with bolt head hex recesses
- SV158 1 1/2" FOAM ADAPTOR SEAL (FOR SV156)

## 3" WASTE TANK SLIDE DRAIN VALVES

Our range of large slide valves are fixed to toilet waste tanks or larger grey waste tanks for efficient emptying. Fix SV303 female threaded tank adaptor flange to tank with bolts and seal with silicone sealant. Male threaded side of 3" valve can now be threaded into female tank adaptor with thread sealed with silicone sealant to locate valve onto tank. The range incorporates a significant array of Adaptors and fittings to cover a wide range of installation situations. Outlet discharge extension hose can easily be connected with straight or curved bayonet hose adaptor. Robust construction from impact resistant black ABS with nitrile and EPDM seals ensures trouble free operation. Long-term maintenance is easily achieved as valves unbolt into their individual components.

- SV300C 3" SLIDE VALVE WITH CAP SHORT HANDLE
- SV300L 3" SLIDE VALVE WITH CAP LONG HANDLE - 600mm
- SV300L120 3" SLIDE VALVE WITH CAP 1200mm VERY LONG HANDLE
- SV300X 3" SLIDE VALVE WITH CAP FOR EXTENSION HANDLE (SVXH...) WITH CAP
- SV301 3" STRAIGHT BAYONET HOSE ADAPTOR
- SV302 3" CURVED BAYONET HOSE ADAPTOR
- SV303 3" FEMALE THREAD TANK ADAPTOR FLANGE
- SV304 3" MALE THREADED TANK ADAPTOR FLANGE
- SV305 3" BAYONET CAP
- SV306 3" BAYONET VALVE FLANGE
- SV307 3" BARREL NIPPLE 125MM LONG
- SV308 3" FEMALE THREAD HOSE ADAPTOR
- SV309 3" FEMALE THREADED FLOOR FLANGE
- SV310 3" BLADE SEAL
- SVSXH 3" VALVE HANDLE
- SV313 3" PLAIN FLANGE with bolt head hex recesses
- SV314C 3" MALE X FEMALE THREADED TUBE NIPPLE 100MM
- SV314L 3" MALE X FEMALE THREADED TUBE NIPPLE 160MM
- SV316 3" FOAM ADAPTOR SEAL (FOR SV301 OR SV302)

## EXTENSION HANDLES FOR 1 1/2" & 3" VALVES

Use with SV150X and SV300X to extend handle to required length. SV150X & SV300X handle rods are 50mm long. Add this onto extension handle length to get approx. overall handle length.

- SVXH150 VALVE EXTENSION HANDLE 150mm + NUT
- SVXH300 VALVE EXTENSION HANDLE 300mm + NUT
- SVXH600 VALVE EXTENSION HANDLE 600mm + NUT
- SVXH1000 VALVE EXTENSION HANDLE 1000mm + NUT
- SVXHNT VALVE EXTENSION HANDLE LONG JOIN NUT
- SVSXH SPARE HANDLE FOR 1 1/2 AND 3" VALVES

For Thetford slide valves and accessories see catalogue page 64.



SV150S SHOWN WITH CAP

\* OPTIONAL



SV156

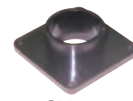

SV151



SV152



SV153



SV154

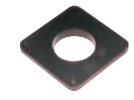

SV157

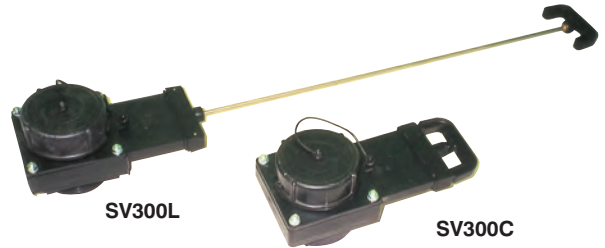

SV300L

SV300C



SV301



SV302

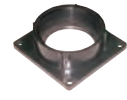

SV303

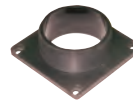

SV304



SV305

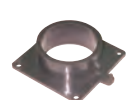

SV306

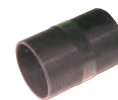

SV307



SV308



SV309

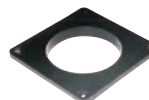

SV313



SV314L



SV314C

SVCASADPT Adaptor to allow connection of a Thetford Cassette base tank to SV300 slide valve for emptying waste tank into the cassette tank.



WE NOW OFFER INSTALLATION SERVICE BY [SupremeTech.co.uk](http://SupremeTech.co.uk)



# US & EURO SLIDE VALVES



## ZADI GREY/RED SLIDE VALVE

Alternative valve fitted to some European Vehicles. Requires connector flanges from 3" range on page 22. Size L245mm x W115mm x T21mm

- SVZ242973 ZADI 3" SLIDE VALVE CARTRIDGE
- SVZ242970 ZADI 3" VALVE BLADE SEAL

## ZADI AIR OPERATED SLIDE VALVE

Fitted to buses, coaches and specialist vehicles. Fitted with 20MM Dia air cylinder with connectors for 6mm nylon air tubing, 10 BAR MAX. Requires connector flanges from 3" range on page 22. Size L360mm x W115mm x T33mm

- SVZ242976 ZADI AIR OPERATED 3" SLIDE VALVE CARTRIDGE

## AIR OPERATED US SLIDE VALVE

Fitted to buses, coaches and specialist vehicles. Fitted with 20MM Dia air cylinder with connectors for 6mm nylon air tubing, 10 BAR MAX. Requires connector flanges from Valterra 3" range on this page. Size L400mm x W110mm x T28mm

- SVAL24736 AIR OPERATED 3" US SIZE SLIDE VALVE CARTRIDGE

## CABLE OPERATED SLIDE VALVE

Cable operated slide valve suitable for installation in difficult to reach positions without direct line of sight where straight rod extended handle valves would not be suitable. Requires connector flanges from Valterra 1 1/2" or 3" range on this page.

- SVAL24709 1 1/2" CABLE OPERATED VALTERRA SLIDE VALVE
- SVAL24739 3" CABLE OPERATED VALTERRA SLIDE VALVE

## 1 1/2" VALTERRA US RV SLIDE DRAIN VALVE SPARES

As fitted on numerous US Recreational Vehicles to fresh or grey waste tanks for quick emptying. Just pull on handle to open the blade valve. Installed by fixing tank adaptor flange to tank with large self-tapping screws or bolts sealed with silicone sealant. Valve can be fixed to adaptor by solvent cement (plumbing glue) in a position to suit easy access for emptying.

- SVAL242942 1 1/2" VALTERRA TANK CONNECTION FLANGE
- SVAL24700 1 1/2" VALTERRA WASTE VALVE CARTRIDGE
- SVAL24711 1 1/2" FLANGE FITTING, HUB FOR 1 1/2" GATE VALVE
- SVAL24713 1 1/2" VALTERRA Mounting flange with collar and 1 1/2" Male thread
- SVAL24714 1 1/2" VALTERRA BAYONET VALVE FLANGE
- SVAL24716 1 1/2" BAYONET STRAIGHT 38MM HOSE ADAPTOR
- SVAL24721 1 1/2" VALTERRA BAYONET CAP
- SVAL24722 1 1/2" VALTERRA VALVE BLADE SEAL

- H5S 1 1/2" SUPAFLEX BLACK WASTE HOSE (see page 24)

## 3" VALTERRA US RV SLIDE DRAIN VALVE SPARES

Larger valve fitted on numerous US Recreational Vehicles to black water toilet waste tanks for quick emptying. Just pull on handle to open the blade valve. Installed by fixing tank adaptor flange to tank with large self-tapping screws or bolts sealed with silicone sealant. Valve can be fixed to adaptor by solvent cement (plumbing glue) in a position to suit easy access for emptying.

- SVAL24731 VALTERRA 3" VALVE COMPLETE
- SVAL24740 FLANGE FITTING 1, 3" SPIGOT MALE SLIP outer dia 89mm
- SVAL24741 FLANGE FITTING 2, 3" hub for 3" gate valve
- SVAL24742 FLANGE FITTING 1, 3" FEMALE THREAD
- SVAL24743 FLANGE FITTING 3" MALE THREAD
- SVAL24744 FLANGE FITTING 3" BAYONET ADAPTOR
- SVAL24752 3" VALTERRA VALVE BLADE SEAL
- SVAL39402 VALTERRA 45 DEG HOSE ADAPTOR
- SVAL39452 VALTERRA 3" BAYONET CAP
- SVAL39513 VALTERRA 3" VALVE CARTRIDGE ONLY
- SVAL56233 VALTERRA STRAIGHT HOSE ADAPTOR

- SVAL88304 VALTERRA 1 1/2" FLANGE TO 3" BAYONET ADAPTOR

- SVAL88302 VALTERRA 40MM MALE PIPE TO 3" BAYONET ADAPTOR
- SVAL88303 VALTERRA 40MM FEMALE SOCKET TO 3" BAYONET ADAPTOR

- SVAL88301 ADAPTOR 3" US TO EURO VALVE

## SUPADRAIN METAL LEVER HANDLE BALL VALVES

Nickel plated metal ball valves for the isolation of fresh or waste water. Use with various threaded connectors from the Supadrain, Megadrain ranges & on pages 20, 21 & 24 in this section to attach to your system. Handle design may vary between sizes.

- SDT075M METAL BALL VALVE 3/4" BSP FEMALE THREADS
- SDT100M METAL BALL VALVE 1" BSP FEMALE THREADS
- SDT125M METAL BALL VALVE 1 1/4" BSP FEMALE THREADS



SDT075M



242973



242976



24709



24736



24700



24711



24713



242942



24714



24716



24721



24731



39513



24740



24741



24742



24743



24744



39402



39452



56233



88304



88303



88301



88302

WE NOW OFFER INSTALLATION SERVICE BY [SupremeTech.co.uk](http://SupremeTech.co.uk)



0844 414 2324



0844 414 2425

Water Tanks - Accessories

Buy securely online at [Leisurelines.net](http://Leisurelines.net)



# HOSE, CONNECTORS, NUT-IN FITTINGS, DRAINTAPS



Water - Plumbing

Buy securely online at [Leisurelines.net](http://Leisurelines.net)

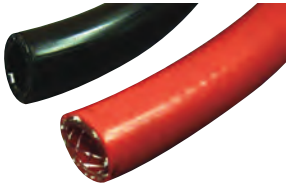

**C.A.K. QUALITY NON TOXIC WATER HOSES**  
**H6CRF** 3/8" (10mm) COLD BLACK REINFORCED  
**H6H** 3/8" (10mm) HOT RED REINFORCED  
**H1CRF** 1/2" (12mm) BLACK REINFORCED COLD  
**H1H** 1/2" (12mm) RED REINFORCED HOT  
**H3RF** 3/4" (20mm) BLACK REINFORCED  
**H2RF** 1" (25mm) BLACK REINFORCED



**C.A.K. SUPAFLEX HOSE**  
 With integral helicoil to prevent deformation when bending around tight corners. Smooth bore (no clog if used for waste) NOW GREY OR BLUE  
**H3SG** 3/4" (20mm) SUPAFLEX GREY HOSE  
**H2SB** 1" (25mm) BLUE **H2SG** 1" (25mm) GREY  
**H5S** 1 1/2" (38mm) SUPAFLEX HOSE  
**H4SB** 40mm BLUE **H4SG** 40mm GREY  
**H7S** 3" (76mm) SUPAFLEX GREY DISCHARGE



**HOSE CLIPS A2 STAINLESS BAND**  
**HC6** 3/8" Hose clip Stainless size 8-16mm  
**HC1** 1/2" Hose clip Stainless size 12-22mm  
**HC2** 1" Hose clip Stainless size 20-35mm  
**HC3** 3/4" Hose clip Stainless size 20-32mm  
**HC4** 40mm & 1 1/2" Clip Stainless size 32-50mm  
**HC7** 3" Hose clip Aluzinc (for 3" Discharge hose)



**NYLON SNAP HOSE CLIPS**  
 (FOR UNDERWATER USE)  
**HBG** SIZE G 1/2"  
**HBH** SIZE H 1/2"  
**HBN** SIZE N 3/4"  
**HBT** SIZE T



**NUT IN TANK FITTINGS**  
**NIFCVD040** 40mm 45 Degree  
**NIFELB010** 3/8" (10mm) Elbow  
**NIFELB050** 1/2" (12mm) Elbow  
**NIFELB075** 3/4" (20mm) Elbow  
**NIFELB100** 1" (25mm) Elbow  
**NIFELB040** 40mm Elbow  
**NIFSTR010** 3/8" (10mm) Straight  
**NIFSTR050** 1/2" (12mm) Straight  
**NIFSTR075** 3/4" (20mm) Straight  
**NIFSTR100** 1" (25mm) Straight  
**NIFSTR040** 40mm Straight



**HOSE CONNECTORS BARBED PLASTIC** Use these connectors to join flexible hose  
**Hose adaptors join 2 different sizes of hose**  
**HCON1012** 3/8" to 1/2" (10mm - 12mm)  
**HCON1520** 1/2" to 3/4" (15mm - 20mm)  
**HCON2025** 3/4" to 1" (20mm - 25mm)  
**Elbow Hose Connector**  
**HELB038** 3/8" (10mm) Elbow  
**HELB050** 1/2" (12mm) Elbow  
**HELB100** 1" (25mm) Elbow  
**Y piece hose connector**  
**HY038** 3/8" (10mm) Y piece  
**HY050** 1/2" (12mm) Y piece  
**HY075** 3/4" (20mm) Y piece  
**HY100** 1" (25mm) Y piece



**Tea Hose Connectors**  
**HTEE038** 3/8" (10mm) Tee  
**HTEE050** 1/2" (12mm) Tee  
**HTEE075** 3/4" (20mm) Tee  
**HTEE100S** 1" (25mm) Tee

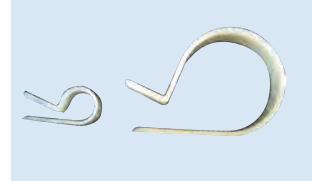

**P CLIPS**  
 P-clips are used to secure piping runs. They are fixed by one screw through fixing hole.  
**HPC1220** 5/16" (8 mm)  
**HPC1225** 5/8" (16 mm)  
**HPC1226** 3/4" (20 mm)  
**HPC1221** 7/8" (22 mm)  
**HPC1228** 1" (25 mm)  
**HPC1252** 1 3/8" (35 mm)  
**WD1250** 1 3/16" (30mm)  
**WD1255** 1 1/8" (28mm)



**CAK BSP TAPER THREADED HOSE BARB CONNECTORS (M = Male, F = Female BSP thread)**  
**STR3812** 3/8" BSP M X 1/2" (12 mm) Straight  
**ELB3812** 3/8" BSP M X 1/2" (12 mm) Elbow  
**STR5012** 1/2" BSP M X 1/2" (12 mm) Straight  
**ELB5012** 1/2" BSP M X 1/2" (12 mm) Elbow  
**BRF3812** 3/8" BSP F X 1/2" (12 mm) Straight brass  
**BRF5012** 1/2" BSP F X 1/2" (12 mm) Straight brass  
**BRM3812** 3/8" BSP M X 1/2" (12 mm) Straight brass  
**BRM5012** 1/2" BSP M X 1/2" (12 mm) Straight brass

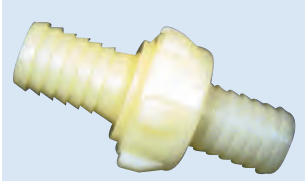

**THREADED HOSE JOINTERS**  
 Nylon fitting barbed both ends. Allows easy connection or extension of two hoses.  
**HFTJ020** 3/4" (20 mm)  
**HFTJ025** 1" (25 mm)  
**HFTJ040** 40 mm Hose

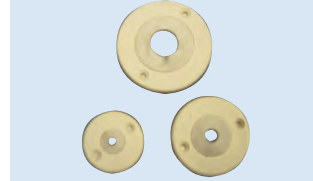

**FLOOR SEAL HOLE TIDIES**  
 Seals around pipes or wires where they go through the floor to reduce draughts, insect or water ingress.  
**HFS1091** For 5 to 11mm Dia.  
**HFS1092** For 10 to 19mm Dia.  
**HFS1093** For 19 to 28mm Dia.



**MINI METAL BALL VALVES**  
 Mini valves female threaded for isolating water systems.

**DTILF038** MINI METAL BALL VALVE 3/8" BSP  
**DTILF050** MINI METAL BALL VALVE 1/2" BSP

**LARGE METAL SUPADRAIN VALVES**  
**SDT075M** 3/4" BSP FEMALE  
**SDT100M** 1/2" BSP FEMALE  
**SDT125M** 1 1/4" BSP FEMALE

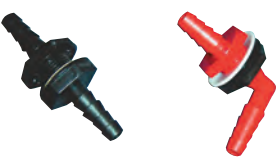

**NUT IN BULKHEAD FITTING**  
 (Hose connection each end)  
**NIFTBS050** 10 / 12mm Straight  
**NIFTBA050** 10 / 12mm Elbow  
**NIFTBA100** 18 / 23mm Elbow  
**NIFTBS100** 18 / 23mm Straight



**TANK DRAIN TAP 1" (25 mm) hose**  
**DTB** Drain tap blue fresh.  
**DTG** Drain tap grey waste.  
**DTN** Drain tap back nut.  
**DTW** Drain tap washer

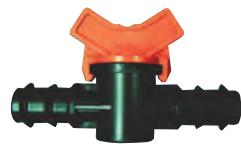

**INLINE DRAIN TAPS**  
 (Low less than 16 psi & non pressurised)  
**DTIL1** 10mm Inline tap  
**DTIL2** 1/2" Inline tap  
**DTIL3** 3/4" Inline tap  
**DTIL3C** 3/4" Waste Inline tap  
**DTIL4C** 1" Waste Inline tap



**NUT IN DRAIN TAP**  
**DTN2** Drain tap nut in 16mm for 13mm (1/2") PVC hose 1/2" BSP nut



**TAP SPRING CLIP**  
**HTC062** 5/8" Zinc plated  
**HTC125** 1.25" Zinc plated  
**HTC125B** 1.25" Black nylon coat

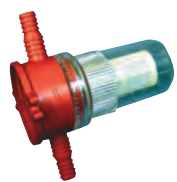

**CAK INLINE STRAINER + TRAP**  
**CAK-WF1** Fine inline filter to suit 10mm & 12mm hose. Easily unscrews for cleaning  
**CAK-WF1SF** Spare mesh strainer

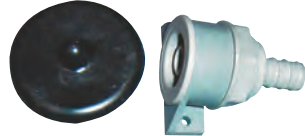

**HOSE SOCKETS**  
 Hose socket + bracket + nut + cap  
**HSKT075** 3/4" Hose socket  
**HSKT050** 1/2" Hose socket

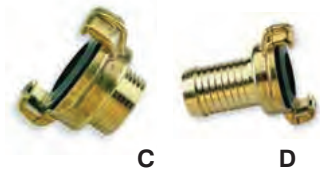

**BAYONET QUICK CONNECTORS**  
 3/4" quickly adds extension hose to SDT099 supadrain tap above. 1" suits larger taps as used by Swift and German vans.  
**HFQB**  
**HFQB075** 3/4" Hose barb brass (D)  
**HFQB075** 3/4" BSP thread brass (C)  
**HFQBH100** 1" Hose barb brass (D)  
**HFQB100** 1" BSP thread brass (C)  
**HFQBAP** Closure cap brass

WE NOW OFFER INSTALLATION & REPAIR SERVICE BY [SupremeTech.co.uk](http://SupremeTech.co.uk)



## SPEEDFIT FRESH WATER PUSH FIT PLUMBING SYSTEM

Speedfit push fit plumbing range for easy installation of fresh, hot and cold water system. Not suitable for use with fuel. Pipe simply pushes home into fitting for a perfect first time seal. Speedfit will grip most 12 & 15mm pipes be they plastic, stainless or copper. Stainless teeth in the collits grip onto these soft or hard surface pipes, so long as they are within diameter size tolerances. Whole systems can be assembled for a clean neat installation. Fittings can be dismounted by pushing back collet and withdrawing pipe. The joint can be broken and re-made as many times as you wish, they will reseal when you push the pipe back in. Whole quick-connect 12 & 15 fittings also available to adapt existing systems. Whole fittings will not hold onto copper or hard polished surface plastic fittings, unless they have 2 circumferencial grooves. For these applications a Speedfit fitting must be used

EQUAL STRAIGHT PM0412E 12MM PM0415E 15MM	EQUAL TEE PM0212E 12MM PM0215E 15MM	EQUAL ELBOW PM0312E 12MM PM0315E 15MM	STOP END PLUG PM0812R 12MM PM0815E 15MM PM4612E 12MM CAP	HOSE ADAPTOR WU1282B 12MM x 1/2" WU1280B 12MM X 3/4"
STEM REDUCER STEM-TUBE PM061210E 12-10mm PM061510E 15-10mm PM061512E 15-12mm	STRAIGHT ADAPTOR (M) MM X BSP PM011213E 12 x 3/8" PM011214E 12 x 1/2" PM011514E 15 x 1/2"	STEM ADAPTOR (M) PM051213E 12x3/8"BSP PM051214E 12x1/2"BSP PM051513E 15x3/8"BSP PM051514E 15x1/2"BSP	COLLET COVER PM1912B 12mm BLUE PM1912R 12mm RED PM1915B 15mm BLUE PM1915R 15mm RED	HOSE ADAPTOR NC448 15mm x 1/2"
BULKHEAD CONNECTOR PM1212E 12mm	STRAIGHT REDUCER PM201210E 12-10mm PM201512W 15 - 12mm	ELBOW REDUCER PM211210E 12-10mm	FEMALE ADAPTOR CM451213FS 12x3/8"BSP CM451214FS 12x1/2"BSP CM451514FS 15x1/2"BSP	MOUNTING CLIPS WU1265 12mm
NON RETURN VALVE DOUBLE CHECK VALVE 15DCV 15mm CP30080212 12mm	INLINE SHUT OFF VALVE 15ESOT 15mm 12SOT 12mm	U BEND PMUB15E 15mm	Y PIECE DIVIDER RM2312E 12mm	MOUNTING CLIPS PC15W 15mm PCSW15 SPACER 1/2"BSP
TANK FITTING PM12+NUT 12mm CM0715E 15mm	STEM ELBOW PM221212E 12mm PM221515E 15mm	TUBE CUTTER CUTS UP TO 22mm TUBE EASILY BY HAND JGTS CUTTER	TUBING PE1209-R 12mm RED PE1209-B 12mm BLUE PE1512-R 15mm RED PE1512-B 15mm BLUE	FLEXI HOSE WITH STAINLESS STEEL OVER- BRAIDING PROTECTION FLX17 300mm 15mm FLX21 500mm 15mm
NON RETURN VALVE WX1582B 15mm	NON RETURN VALVE 12SCV 12mm	Cut the pipe square ensuring it is free of score marks. We recommend you use the JGTC pipe cutters for best results.	To avoid damage to the 'O' Ring, make sure burrs and sharp edges are removed. <b>DO NOT</b> use a Hacksaw. The burrs will prevent the fitting from sealing correctly	With the fitting clean and undamaged and the pipe cut square, you are now ready to make the connection
THREE WAY VALVES TWV038 3/8" BSP FEM TWV050 1/2" BSP FEM	Reducing collar 1/2" BSP male x 3/8" BSP female. DLTRF0538 Reducer	HPVCTC PVC tube cutters	Water quick connector for easily attaching equipment. 3/8" BSP Male. DLTRWC W. Q. CONN	Stem elbow to fit Whale Elite WMT wall mounted shower sets WU1222B Elite stem elbow

WE NOW OFFER INSTALLATION & REPAIR SERVICE BY [SupremeTech.co.uk](http://SupremeTech.co.uk)



0844 414 2324



0844 414 2425



# PUSH FIT WASTE PLUMBING & SMELL TRAPS



Water - Plumbing

Buy securely online at Leisurelines.net

## 25 / 28 MM EASY FLOW PUSH FIT WASTE PIPE SYSTEM

Larger bore easy flow push fit waste water piping system for Motorhomes & Caravans, easily fitted by simply pushing the rigid pipe and fittings together. Much higher waste water flow rates from your sink and shower will make a significant improvement to the drain-ability of the kitchen sink. Supaflex smooth bore waste pipe mixes into the system to make installation in tight spots easier. You can switch between rigid and 25mm Supaflex as many times as necessary, by using **WD1322** & **WD1323** adaptors. **WD1323** can be put into any fitting including sinkwastes to go straight onto 25mm Supaflex for pipe runs, to change from 25mm Supaflex onto rigid pipe or the reverse use **WD1322**.

This range is suitable for most installations. Small panel van conversions should use 20 or 25 mm Supaflex, or a combination of 25mm supaflex hose below floor, to snake around obstructions on route to waste tank, with 28mm rigid used on the straighter runs. Larger systems can use any combination of the fittings, 28mm rigid and 25mm supaflex, to create the waste system.

**WD1320 28MM RIGID PIPE 3MTR LENGTHS (A) must be cut to 1.5m maximum to prevent excess carriage charges from the parcel carrier.**

## 25 / 28 MM EASY FLOW PUSH FIT WASTE PIPE SYSTEM

- H2SG** 25MM SUPAFLEX SMOOTH BORE WASTE HOSE (See page 24)
- WD1250** 1 3/16" P CLIP (SUIT 25MM SUPAFLEX) (See page 24)
- WD1255** 1 1/8" P CLIP (SUIT 28MM RIGID PIPE) (See page 24)
- WD1320** 28MM GREY PUSH FIT RIGID PIPE 3MTR LENGTHS (A)
- WD1300** 1 1/4" - 28MM ANGLED SINKWASTE S/S TOP CW PLUG (C)
- WD1304** 1 1/4" - 28MM 90 DEG SINK WASTE S/S TOP CW PLUG
- WD1306** 1 1/4" - 28MM STRAIGHT SINKWASTE S/S TOP CW PLUG (B)
- WD1319** 28MM THRU FLOOR ADAPTOR
- WD1321** 28MM PUSH FIT STRAIGHT CONNECTOR
- WD1322** 25MM SUPAFLEX HOSE - 28MM FEMALE SOCKET ADAPTOR (H)
- WD1323** 25MM SUPAFLEX HOSE - 28MM MALE PIPE ADAPTOR (J)
- WD1324** 28MM PUSH FIT STEM ELBOW (F)
- WD1325** 28MM PUSH FIT EQUAL ELBOW (G)
- WD1326** 28MM PUSH FIT 135 DEGREE CONNECTOR (E)
- WD1327** 28MM PUSH FIT TEE CONNECTOR (K)
- WD1328** 28MM PUSH FIT Y CONNECTOR (D)
- WD1330** 28MM OUTLET HOSE SOCKET
- WD1430** 28MM OUTLET HOSE SOCKET FACE FIX
- WD1420G** 28MM NUT IN TANK FITTING STRAIGHT MALE
- WD1421** 28MM 1" BSP TANK FITTING STRAIGHT FEMALE
- WD1424** 20MM SUPAFLEX HOSE - 28MM MALE PIPE ADAPTOR
- WD8252** PIPE SADDLE CLIP 28MM
- HY100** Y PIECE FOR JOINING TWO WASTE OUTLET PIPES IN TO ONE WASTE CONTAINER (See page 24)

- WD8531G** GREY MOUNTING BRACKET FOR 8532G GREY WASTE TAP
- WD8531B** BLUE MOUNTING BRACKET FOR 8532B BLUE WASTE TAP
- WD8532G** GREY WASTE TAP 28MM
- WD8532B** BLUE WATER TAP 28MM

**Most of above Range now available in Blue enquire for details.**

## 28 MM WASTE WATER INLINE SMELL TRAP

New larger smell trap to fit directly into 28mm rigid pipe. Lower bowl is removable at a twist to allow easy cleaning. The Trap can be fitted into 25mm Supaflex by using **WD1323** adaptor. To retrofit the trap into an existing 20mm (3/4") Supaflex waste pipe system use the new **WD1424** 20mm to 28mm adaptor.

- WD1425G** 28MM Waste water smell trap

## WASTE WATER INLINE SMELL TRAP NOW ALSO 25MM

An innovation for the waste water system. A simple but effective trap to prevent waste tank smells from permeating back up the waste pipe from the waste holding tank.

The Waste Water Trap **HGWT** is straight forward to fit. Simply cut into the vertical section of 1/2" waste pipe from the sink waste going to your waste tank fit the trap into the pipe with the screw holes uppermost. Secure the hoses with a little silicone sealant and hose clips. Now screw the trap to the nearest secure position to prevent it from movement. The trap is now fitted. From time to time you may need to remove the trap to backwash any large debris.

- HGWT** Waste water trap for 3/4" (20mm) waste hose
- HGWT25** Waste water trap for 1" (25mm) waste hose

## LARGE BORE NON RETURN VALVES FOR WASTE WATER

Large bore inline non-return valves to prevent waste water backing up into your shower tray, particularly when travelling up or down hills or when the waste tank is full. Can also be used to maintain prime in a suction pipe, to a macerator pump etc. in marine applications. Available for 3/4" (20mm), 1" (25mm) & 1 1/2" (38mm) hose.

- WLV1215** 1" & 1 1/2" (25 - 38 mm) Non return valve. Length 125mm
- WLV1219** 3/4" (19 mm) Non return valve.

## NUT IN SKIN FITTINGS

Designed as an inside out version of our normal nut in tank fittings these skin fittings have the nut on the outside of the tank. Suitable for most above waterline outlets for marine use through hull or as a tank fitting. The fittings are Corrosion and electrolysis free. Hose tail can be cut off to use with threaded fittings. (Size refers to hose size to suit tail end)

- NISF016A** 5/8" 16MM Angled skin fitting with nut
- NISF075** 19mm 3/4" skin fitting with nut
- NISF75A** 19mm 3/4" Angled skin fitting with nut
- NISF100** 25mm 1" skin fitting with nut
- NISF038** 1 1/2 38mm skin fitting with nut
- NISF050** 50mm skin fitting with nut
- NISF8035** 1/2" 3/8" ANGLED SKIN FITTING

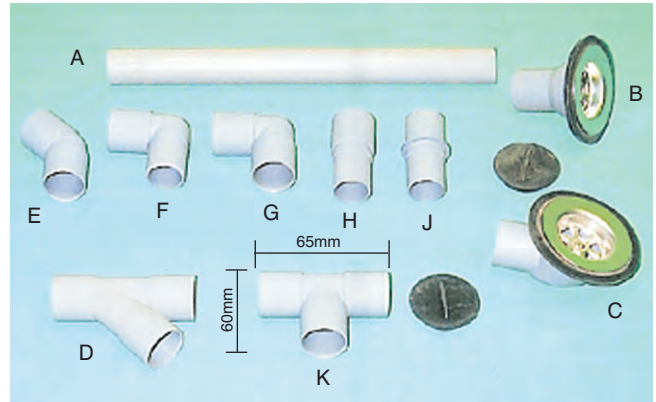

NUT IN SKIN FITTINGS



NISF8035



LARGE WASTE NON RETURN VALVE

WLV1215 WLV1219

WE NOW OFFER INSTALLATION & REPAIR SERVICE BY [SupremeTech.co.uk](http://SupremeTech.co.uk)

**Trailing pumps** for automatic pumping of fresh water on demand with the quality and reliability expected from Shurflo. Highly recommended by C.A.K. ideal for any vehicle or application.

- Heavy duty fully automatic triple diaphragm pumps
- Twin ball bearing drive & cast alloy motor casing
- Extremely smooth & efficient
- Self priming to 2.5m on 7 ltr models and 3.6m on 10.6 ltr models
- Runs dry without damage
- Slow running motor extends pump life
- Low amp draw & internal circuit breaker
- 2 barbed fittings and threaded strainer supplied with each pump



Shurflo Marine Pumps see page 131

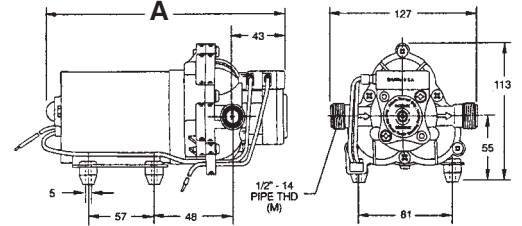

A = 197mm for 7 ltr models, A = 226mm for 10 ltr models.  
Approximate measurements for all pumps

## SHURFLO TRAILING PUMPS (FOR LAND BASE USE)

(2 barbed fitting & threaded strainer supplied with pump) Long standing reputation for quality and reliability. The pump of choice for professional use. C.A.K. highly recommends this product range.

**SHURFLO 2095 TRAILKING 7 - 7 ltr per min flow high quality, heavy duty, fully automatic, self priming (2.5 mtr), triple diaphragm pump. Extremely quiet & efficient. (pump isolation switch required use MC12N)**

**20 PSI** cut off pressure to suit cascade, Atwood, Malaga, Mini 8, Truma, Whale, Caravan boiler & Nautic Boiler.

**30 PSI** cut off pressure to suit older instantaneous heaters, Paloma (not PH5 LFE), Rinnai, Vaillant.

**TRAILKING 10** as 2095 but increased **10.6 ltr** (2.3 gals) per min flow. Self primes to 3.6 mtr

**For most Caravan and Motorhome applications the SF120720 is the required pump.**

SF120720	SF2095 TRAILKING 7 LTR 12 VOLT 20 PSI
SF120730	SF2095 TRAILKING 7 LTR 12 VOLT 30 PSI
SF121020	SF2095 TRAILKING 10.6 LTR 12 VOLT 20 PSI
SF121030	SF2095 TRAILKING 10.6 LTR 12 VOLT 30 PSI
SF241030	SF2095 TRAILKING 10.6 LTR 24 VOLT 30 PSI

## 240V MAINS POWER SHURFLO PUMP

(2 barbed fitting & threaded strainer supplied with pump) Same design and performance as Trailing 10 pumps but running on 240 volts mains electric power. CE EMC approved.

**SF240V1030** SF2095 TRAILKING 10.6 LTR MAINS 240 VOLT 30 PSI

## SHURFLO ACCESSORIES

SFELB050	SPARE SWIVEL ELBOW 1/2" PIPE BARB PUMP FITTING <b>A</b>
SFSTR050	SPARE SWIVEL STRAIGHT 1/2" PIPE BARB PUMP FITTING <b>B</b>
SFSGF1	SPARE SHUR-GUARD TWIST ON STRAINER + 1/2" PIPE BARB <b>C</b>
SFSGF2	SPARE SHUR-GUARD TWIST ON STRAINER + 1/2" THREAD <b>D</b>
SFSGF3	SPARE SHUR-GUARD INLINE STRAINER + 1/2" THREAD/ BARB <b>E</b>

## SHURFLO 182 ACCUMULATOR

Smooths water flow to reduce water surge and pressure switch machine gunning. Especially useful on semi rigid systems. High specification design to provide proficient operation, high quality construction.

**SFAC181** ACCUMULATOR TANK 182 WITH DIAPHRAGM

## WHALE SUPERFILL

The easy and convenient way to fill caravan, motorhome & specialist vehicle on-board water tanks or cassette toilets from a water container. Removes the unnecessary effort in heavy lifting and pouring water into filler. Simply plug into socket and water will be pumped up into your filler from the hose. Uses submersible 12v DC electric pump, hose and electric plug assembly, Socket for connecting into the existing caravan electrical circuit. Full step by step instructions.

**WGP1332** SUPERFILL WATER FILLING PUMP KIT

## NEW PORTABLE PUMP KIT

Ideal for washing down the car or boat, pumping diesel, showering, drinking water filling, Container filling/emptying, Spraying/garden watering, Bilge/storm water clearance and many more applications. Low voltage (8 amp, 12 Volt D.C) highflow submersible pump with adjustable on/off nozzle providing fine spray or a jet of water, 3.75m (12.5ft) food quality clear hose & 3.75m (12.5ft) cable with battery crocodile clips and a cigarette lighter plug.

**WGP1642** PORTABLE PUMP KIT

**WGP1642** PORTABLE PUMP KIT

## PORTABLE SHOWER KIT

New self contained portable shower canister. Ideal to shower off dogs, muddy boots, bicycles, or just hand washing. Built in 12 litre per min submersible pump with 4m of 12 volt connection cable & universal plug, Trigger shower handset pulls out of canister, hose (approx. 2 Mt.) is stored inside canister. Not to be used with hot water (warm tap water OK with care) or freezing conditions or pump may be damaged. Do not run dry. Canister size 290mm x 255mm x 390mm high.

**SKP50200** Portable shower kit 20L container 12volt.

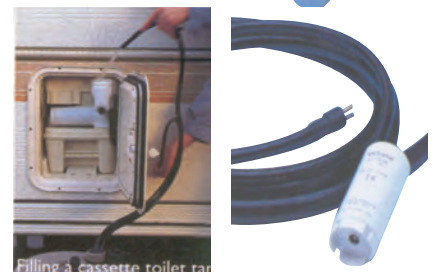
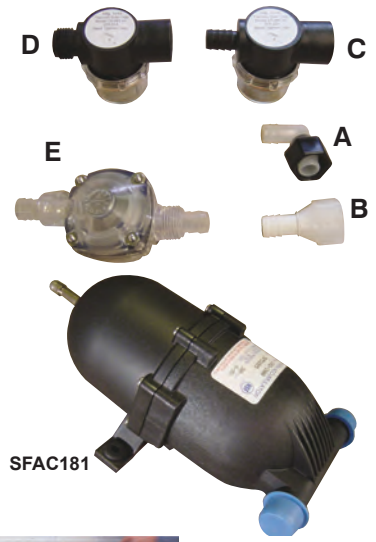

WGP1332



WGP1642



WE NOW OFFER INSTALLATION SERVICE IN KENILWORTH BY [SupremeTech.co.uk](http://SupremeTech.co.uk)



Water - Pumps

Buy securely online at [Leisurelines.net](http://Leisurelines.net)

### COMET IMMERSION PUMPS (10mm connections)

- CP130001** ELEGANT SUB PUMP, 12v, 8 Litres/min, delivery height max 5m, cable length 1mtr. Diameter 38mm x 104mm
- CP131001** ELEGANT SUB PUMP with air lock release, 12v, 8 Litres/min, delivery height max 5m, cable length 1mtr. Diameter 38mm x 120mm (3/8" & 1/2" barb hose connection)
- CP143012** VIP-PLUS SUB PUMP, 12v, 20 Litres/min, delivery height max 11m, cable length 1mtr. Diameter 48mm x 123mm
- CP160063** GEO SUB PUMP 12v, 14 Litres/min, delivery height max 7m, cable length 1mtr. Diameter 42mm x 125mm
- CP163077** GEO-PLUS SUB PUMP 12v, 18 Litres/min, delivery height max 10m, cable length 1mtr. Diameter 42mm x 125mm



### COMET INLINE PUMPS (10mm connections)

- CP170063** GEO-INLINE PUMP, 12v, 14 Litres/min, delivery height max 7m, cable length 1mtr. Diameter 42mm x 150mm
- CP172077** GEO-INLINE-PLUS PUMP, 12v, 18 Litres/min, delivery height max 10m, cable length 1mtr. Diameter 42mm x 150mm



### INLINE 12MM NON RETURN VALVE

- CP30080212** Inline Non-return valve for 12mm speedfit push fit plumbing.

### HOSE ADAPTORS FOR INLINE PUMPS

- CP91410212** Straight adaptor pump to 12mm speedfit push fit plumbing
- CP91420212** Elbow adaptor pump to 12mm speedfit push fit plumbing
- CP30040200** non return adaptor pump to 10mm (3/8") PVC Flexi
- CPC1060501** Straight air release adaptor pump to 10 / 12.7mm barb (3/8"-1/2") PVC Flexi hose.



### COMET DOME FOOTSWITCH

- CPFS3330** Comet dome footswitch 60 ∅ x 20mm H

### COMET FLORENZ TAP

- DCT2371MN** 90∅ swiveling single lever mixer tap black / matt nickel effect with micro switch. 40mm high for glass lid sinks. Installation hole is 33mm∅ thread length 35mm. Spout length 150mm. Supplied with flexible tails with 12mm barb.



### COMET FLORENZ SHOWER TAP

- DCT2385C** Single lever chrome mixer tap with 1/2" shower outlet & micro switch. 40mm high. Installation hole is 33mm∅ thread length 35mm. Supplied with 12mm hose barbs.



### COMET LONDON TAP

- DCT2217C** Single lever mixer tap black / chrome effect with micro switch. 40mm high for glass lid sinks. Installation hole is 27mm∅ thread length 29mm. Spout length 150mm. Supplied with 12mm hose barbs.

### COMET NOVO-SUPER

- Mounting holes 17mm ∅ thread length 23mm. Mixer mounting hole centres 86mm. Height 185mm / 32mm spout folded. Max pressure 1.5bar. With micro switches. Supplied with 12mm hose barbs.

- DCT2111MN** SINGLE TAP MATT NICKEL EFFECT
- DCT2115MN** MIXER TAP MATT NICKEL EFFECT
- DCT2111GY** SINGLE TAP MATT light grey/dark grey
- DCT2115GY** MIXER TAP MATT light grey/dark grey

### COMET STILO SINGLE LEVER MIXER TAP

- DCT4710C** Modern metal single lever domestic style tap with 360∅ swiveling spout. Mounting hole 38mm∅, Spout distance 200mm, Overall height 335mm. 12mm female push fit connections on flexi hoses. Suitable for pressurised water systems.



### COMET TAP MICROSWITCHES

- DCT9210** Spare micro switch for ROMA, DUCALE, FLORENZ ranges
- DCT3025** Spare micro switch for NOVO SUPER & LONDON

### WHALE SHOWER SET

- WTT2000** Curved chrome riser bar with acrylic soap dish. Adjustable shower head location bracket, 1.5mtr flexible chrome hose & shower head.



On 3/8" BSP flexi tails use BRF3812 brass female barbs to connect 1/2" PVC hose, or CM451213FS to connect to 12mm push fit plumbing.

WE NOW OFFER INSTALLATION & REPAIR SERVICE BY [SupremeTech.co.uk](http://SupremeTech.co.uk)



## UNIVERSAL AUTOMATIC PUMP FOR LAND BASED & MARINE USE

An innovative design Quad pump from Whale. BUILT IN PRESSURE SWITCH, Self primes to 3m with flows of 8, 12 & 18 litres per minute. SMOOTH FLOW designed to pump sufficient water that flows smoothly and efficiently. QUIET designed for noise absorption to give quieter operation. FULLY ENCLOSED motor, wires & pressure switch (setting is not adjustable). LOW POWER CONSUMPTION energy efficient and kind to batteries. Now includes filter and 15mm push fit connections, adaptors for 1/2" hose available. Highly recommended by C.A.K.

WUF0812 12 VOLT UNIVERSAL 8 LTR 15PSI    WUF1214 12 VOLT UNIVERSAL 12 LTR 30PSI  
WUF1212 12 VOLT UNIVERSAL 12 LTR 15PSI    WUF1215 12 VOLT UNIVERSAL 12 LTR 45PSI  
WUF1815 12 VOLT UNIVERSAL 18 LTR 45PSI

## SMARTFLO VERTICAL

Variable pressure demand pump (30 PSI) automatically adjusts flow to meet outlet demand. Reduces the need of an accumulator tank in rigid piping systems. 12V DC only. Now installed vertically to save space.

WUV0814 12 VOLT SMARTFLO VARIABLE DEMAND PUMP

## AQUASMART VERTICAL

Compatible with all external pump caravan water systems, the Aquasmart upgrades water system from a plug in pump to a pressure diaphragm pump. Aquasmart is easy to install & provides better all round flow rates to your caravan. It replaces stand-alone pressure switches to reduce pulsing of water flow & has a built in replaceable carbon filter.

WAQ0814 12 VOLT AQUASMART WATER DELIVERY SYSTEM  
WUH0814 SPARE PLUG AND HOSE ASSEMBLY WITH FILTER  
WWF3000 SPARE FILTER FOR AQUASMART SYSTEM

## CAK-SPA12 SUBMERSIBLE PUMP TO TANK ADAPTOR

Makes fitting of submersible pumps to C.A.K. TANKS onboard water tank systems very easy. Pump is easily removed for maintenance or replacement. Fits 1/2" PVC & 12 / 15mm Push fit

## SUBMERSIBLE ELECTRIC PUMPS

WGP1002 GP1002 STANDARD SUBMERSIBLE PUMP 12 V Not illus  
WGP1352 PREMIUM SUB PUMP 12 V (PIC C)  
WGP1354 PREMIUM SUB PUMP 24 V (PIC C)

Anti-airlocking self-venting design improves performance. No priming problems being totally submerged. Output of 13.2 litres, 3.6 amps (GP1352/54) makes these pumps suitable for storage water heaters & showers in the smaller system. Can be fitted into onboard water tanks. Designed to pump fresh & saltwater. (GP1002 not self-venting for small single outlet system 10.3 lpm 2.4 amps)

WGP1652 HIGH FLOW SUB PUMP 12 V (PIC D)  
The most powerful self-venting pump in the range provides up to 15.8 litres per min (3.8 amps). Suitable for fitting into onboard water tanks. Designed to pump fresh & saltwater.

## INLINE & BOOSTER PUMPS

WGP1392 PREMIUM INLINE PUMP 12 V (PIC A)  
WGP1394 PREMIUM INLINE PUMP 24 V (PIC A)

Effective inline pump can be used to boost hand or foot pump systems. Output of 13.2 litres makes these pumps suitable for storage water heaters and showers in the smaller system. Suitable for fitting inline from onboard water tanks. Designed to pump fresh, saltwater & diesel.

WGP1692 GP925 HIGH FLOW INLINE PUMP 12 V (PIC B)  
The most powerful inline pump in the range provides up to 15.8 litres per min. Suitable for fitting to onboard water tanks. Designed to pump fresh, saltwater and diesel.

WWU1211 ADAPTOR 11-12  
To connect sub and inline pumps to Whale and Speedfit 12mm push fit plumbing

## WHALE ACCESSORIES

WWU7207 INLINE PRESSURE SWITCH  
Provides water on demand for many applications. Simple set up & installation for efficient pressurised system. For 1/2" PVC hose or 12mm Push fit plumbing.

WBS7204 BUTTON SWITCH  
Neat little non latching push button control for pumps.

WFS7210 FOOT SWITCH  
Simple & effective non latching contact switch for pump control. Can be mounted on floor or wall. Hands free operation of pump.

WFW1227B PLASTIC 1/2" NON RETURN VALVE  
WFW1235 CHROMED BRASS 1/2" NON RETURN VALVE  
Ensures maintenance of prime in non self-priming systems. Chrome version recommended where hose clips have to be tight.

## WATERMASTER PLUG IN PUMP KIT

Simple system to allow submersible pump to be plugged into an external socket to pump water from an outside container into water system. Choose a socket, then watermaster plug & pump assembly to complete. All 12 volt only. Socket WES1000 can be used with Aquasource mains water kit to bring mains fed water directly into the water system, without pump operating.

WES1000 WATERMASTER SOCKET FOR MICROSWITCH SYSTEM  
WES1001 WATERMASTER SOCKET WITH PRESSURE SWITCH

## WATERMASTER PLUG & PUMP ASSY

Replacement pump assembly for caravans with Whale Watermaster socket  
WEP1312 PREMIUM PUMP ASSY FOR WHALE 13.2 lpm  
WEP1612 HIGHFLOW PUMP ASSY FOR WHALE 15.8 lpm

## PLUG IN PUMP FOR CARVER TRUMA CRYSTAL SOCKETS

Direct replacement plug in pump assembly for Carver or Truma crystal water inlets.  
WEP1322 PREMIUM PUMP ASSY FOR TRUMA/CARVER  
WEP1622 HIGHFLOW PUMP ASSY FOR TRUMA/CARVER

## AQUASOURCE DIRECT MAINS WATER INPUT KIT

Provides direct water supply to caravans with whale Watermaster or Carver Truma sockets. Just plug into socket and pressure reducer in plug with allow mains water to run your water system. No need to run your pump while hooked up to mains water. Can be retrofitted to other systems by the addition of a WES1000 Watermaster socket and a non-return valve, it is then teed into the system after the pressure pump.

WEM9401 AQUASOURCE MAINS WATER KIT  
WEM9403 AQUASOURCE 7.5 MTR EXTENSION HOSE

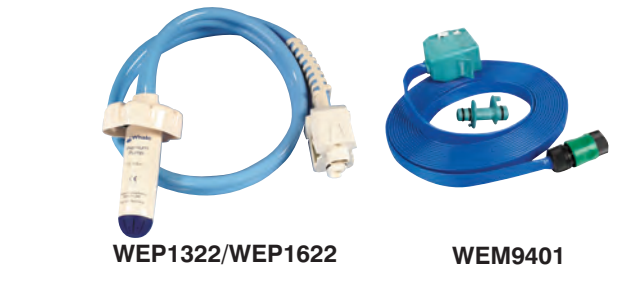
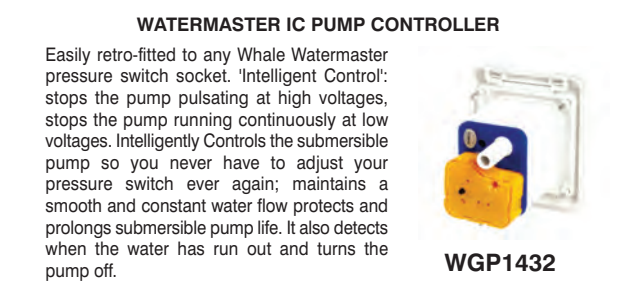
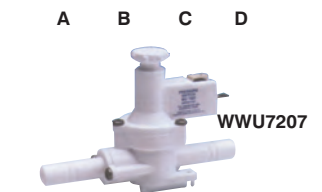
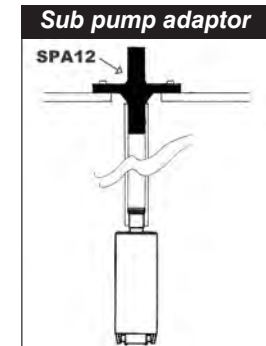

Water - Pumps Buy securely online at [Leisurelines.net](http://Leisurelines.net)



Water - Taps & Showers  
Buy securely online at Leisurelines.net

## ELEGANCE TAPS

Suitable for pressure or microswitch systems. Single taps base plate 113mm x 55mm (4 1/2" x 2 1/8") Mixer taps base plate 171mm x 62mm (6 3/4" x 2 1/2") Depth beneath surface 92 mm (3 5/8")

- WRT1007B** RT1000 white single tap long outlet
- WRT1010** RT1000 white single tap short Combo outlet
- WRT2010** RT2000 white mixer tap short Combo outlet
- WRT2007B** RT2007 white mixer tap long outlet

Microswitches need to be installed in taps where they are used to control non-automatic pumps, such as submersible pumps. Single tap requires one, a mixer tap 2 switches. When taps are used with fully automatic pumps such as Shurflo or universal pumps a microswitch is not required.

- WRT9000** Microswitch kit for elegance taps (pack of 2 switches)
- WRT1023B** Single control unit for elegance

## ELEGANCE SHOWERS

### COMBINATION SHOWER / MIXER UNITS

**WRT2500** handset with shower, tap & on / off function control. Can be used in the washbasin as a tap or as a shower by using a wall bracket or riser bar. Water flow can be temporarily shut off on showerhead maintaining the temperature setting. Retracting hose allows dual use of combo showerhead as a basin mixer tap. **WRT2500** combo tap/shower is suitable for installation in Contessa tip up sink see Page 68

- WRT2500** Mixer combo tap/ shower & wall bracket white
- WRT7500** Mixer combo tap/ shower & wall bracket beige
- WRT2525** Mixer combo with remote outlet white (to order only)

### ELEGANCE RISER BAR & WALL BRACKETS

Elegance Riser Bar provides 19 3/4" of height adjustment for combination handset showers. A wall bracket is a single point location fixture for a shower head it allows single alternative positions for the combo head.

- WRT1250** Shower wall bracket white
- WRT1750** Shower riser bar white
- WRT6250** Shower wall bracket beige
- WRT6750** Shower riser bar beige

### ELITE SINGLE LEVER TAPS

Single lever mixer tap with ceramic valves suitable for use on for pressurised or microswitch system. Suitable for direct fitting of 12mm Push-fit Piping, to fit 1/2" flexible PVC hose you will require 2 x WWU1282 adaptors. All Elite fitted with Microswitches. **Base diameter 58 mm, Hole diameter 48mm.**

- WMT0113** Elite single lever mixer tap chrome short spout
- WMT0111** Elite single-lever mixer tap chrome long
- WMT0161** Elite single-lever mixer tap diamond white long

### ELITE SINGLE LEVER SHOWERS

Shower comes complete with shower hose and handset. Requires Elite riser bar to hold showerhead in position this must be ordered with shower. All Elite fitted with Microswitches so are suitable for pressurised or microswitch systems. Suitable for direct fitting of 12mm Push-fit Piping to control valve, to fit 1/2" flexible PVC hose you will require 3 x WWU1282 adaptors. Shower hose connection block requires adapter CM451214FS for 12mm Push-fit, & additionally 1 x WWU1282 for 1/2" flexible PVC hose. Base dia. 58 mm, Hole dia. 50 mm.

- WMT0140B** Elite single-lever mixer shower chrome
- WRT1780B** Elite shower riser bar chrome
- WRT1770B** Elite shower riser bar white

### SWIM 'N' RINSE EXTERNAL SHOWER

Built in exterior shower compartment. Attractive design adds a touch of luxury to any boat or motorhome. Unit has a hinged cover with key lock, simple to install. 2.1 mtr hose (7 ft), On/off control on combo handset. Overall dimensions 167mm wide 298mm high. Colour white. BSP Male connections. Use SFELB050 Elbow or SFSTR050 Straight for PVC hose.

- WRT2662** Swim n' rinse external shower with lock

### SIMPLE FAUCETS

**WFT1152** TELESCOPIC FAUCET WHITE for use with foot or electric pumps. Faucet can be pushed down to fit neatly under most folding worktops & swivels 360°.

**WFT1268** TUCKAWAY FAUCET WHITE Fits into vertical side of sink or bowl, folding down into bowl when not in use. Faucet swivels 360°.

### SURGE DAMPER

Smooths water flow in the water system. Can reduce system noise and pulsations. Especially suitable for semi-rigid systems with submersible type pumps. It is a much-simplified version of an accumulator. Accumulators (see page 27) should be used with diaphragm pressure pumps to aid pressure switch control in the piping system, particularly when using push fit plumbing. Max 4 bar 60psi. Size L 213mm x Ø 50mm. Capacity ¼ pint.

- WWU7205** Surge damper 12mm push fit connection
- WWS7215** Surge damper 15mm push fit connection

### AQUASOURCE CLEAR INLINE WATER FILTER

Provides clear fresh drinking water by removing unpleasant tastes and smells. Contains silver activated carbon that inhibits bacterial growth. Slim & compact, easy to install. Lasts one full season or 4500 litres whichever comes first.

- WWF1230** Aquasource clear inline water filter 12mm
- WWF1530** Aquasource clear inline water filter 15mm

### WHALE METAL SINGLE LEVER TAPS

Single lever chromed brass mixer taps with ceramic valves suitable for use on for pressurised systems only. Supplied with 1/2" flexible hose tails.

- WTT1111** Single Lever Kitchen Chrome Tap, 220mm spout 120mm high
- WTT1211** Swan Neck Kitchen Chrome Tap, 331mm spout 232mm high
- WTT1311** Single Lever Vanity Chrome Tap, 140MM spout 70mm high

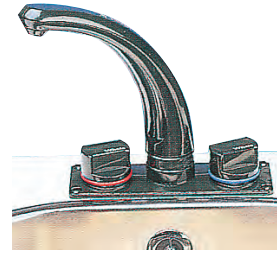

**ELEGANCE LONG MIXER**



**ELEGANCE COMBO SHOWER**



**ELEGANCE COMBO SHOWER**



**ELITE TAPS**



**ELITE SHOWERS**

**WRT 2662**



**WWS7205 SURGE DAMPER**



**TELESCOPIC**

**TUCKAWAY**



**WWF1230 WWF1530**



**WTT1211**



**WTT1111**



**WTT1311**

WE NOW OFFER INSTALLATION & REPAIR SERVICE BY [SupremeTech.co.uk](http://SupremeTech.co.uk)

## DLT539 TAP FOR SMEV 8000 SERIES

**DLT539** Single lever tap neat and compact styling. Comes in attractive colour of Matt Nickel and black trim. Good colour match to SMEV stainless range. Suitable for use with pressurised & micro switched water systems. Connections suitable for 12mm & 10mm (1/2" & 3/8") flexible PVC hose. This mixer tap will fit Smev 8000 series sinks. 25mm Hole cut out, spout length 85mm end to centre of tap.

**DLT539** Matt nickel single lever mixer tap for Smev 8000 series sinks

## DLT540 SINGLE TAPS AND DLT541 MIXER TAPS.

Modern good quality taps in a range of colours. Compact design allows them to be fitted in most situations. Suitable for pressurised & microswitched water systems. Connections suitable for 10mm (3/8") flexible PVC hose, for 12mm (1/2") flexible PVC hose you will require a **DLTBARB** for each water connection.

The **DLT541W** mixer in white is the only tap suitable to fit the Cleo tip up basin (see page 68)

The **DLT540C** Matt Nickel is the most popular single cold tap that will fit Smev 8000 series

**DLT540B** Single tap + microswitch colour Beige

**DLT540BR** Single tap + microswitch colour Brown

**DLT540W** Single tap + microswitch colour White

**DLT540C** Single tap + microswitch Matt Nickel effect

**DLT541B** Mixer tap + microswitch colour Beige

**DLT541W** Mixer tap + microswitch colour White

**DLT541C** Mixer tap + microswitch Matt Nickel effect

**DLTBARB** Adaptor for 540/ 541 range for 12mm (1/2") PVC hose

## EXTERNAL VERTICAL SHOWER UNIT

The external shower kit has a ceramic valve operated chromed brass mixer unit and a pull out shower with 2 metres of hose. Box requires cut out of 185mm x 108mm, Maximum wall thickness 40mm. Overall flange size 233mm x 153mm. Supplied with flexi tails 3/8" BSP male thread. Suitable for pressurised water systems only. Box only also available without shower kit.

**DLTEXVS** External vertical shower kit white

**DLTEHL** External housing only with lock

## MINI EXTERNAL PLUG IN SHOWER UNIT

The mini external shower kit has a quick connect plug in water valve. The trigger showerhead and its 2 metre hose simply plug in with a click. Housing cut out 59mm diameter, Flange diameter 82 mm. Suitable for pressurised water systems only. Box only also available without shower kit.

**DLTMES2W** Mini External plug in shower unit with 2 m hose

## EXTERIOR PULL OUT SHOWER UNIT

The new exterior pull out shower kit has a ceramic valve operated chromed brass mixer unit and a pull out shower with 2 metres of hose. Box requires cut out of 95mm diameter, Maximum wall thickness 70mm. Overall flange size 126mm x 132mm. Supplied with flexi tails 3/8" BSP male thread. Suitable for pressurised water systems only. Box only also available without shower kit.

**DLTEXS4** Exterior vertical shower kit 4 white

**DLTEXS4STSHW** Spare white trigger shower head for DLTEXS4

**DLTEH4** Exterior housing 4 only

## TRIGGER SHOWER HEADS

Replacement trigger shower head for better on-off control of showering at the head. Depress trigger and water will flow to suit, Push trigger down and forward to lock on body the shower will then be on all the time. Both have 1/2" male thread to easily connect to most shower hoses.

**DLTTSHC** Spare Trigger head chrome 1/2" bsp male thread

**DLTTSHW** Spare Trigger head white 1/2" bsp male thread

## THRU WALL OR COUNTERTOP SHOWER MIXERS

These new showers either fix through the mounting surface (**DLTSHMCC**) or mounts onto surface (**DLT3440C**). All connections, hot & cold in and mixed out, are behind the mixer control. This allows all the piping to be hidden within the wall or under the countertop. Use **DLTSWC** to connect the mixed output to the shower hose.

**DLTSHMCC** Thru wall shower control chrome (3 x 1/2" BSP female conn.)

**DLT3440C** Single lever under mixer control shower

**DLTSWC** Thru wall water connection for showers (3/8" male connection)

## SHOWER KIT

Chrome Shower head with Chrome hose 150cm long and fixed position shower wall holder. 3/8" BSP female connection.

**DLTSK3420C** Chrome shower kit, Handset, Hose & Fixed Bracket

On 3/8" BSP flexi tails use **BRF3812** brass female barbs to connect 1/2" PVC hose, or **CM451213FS** to connect to 12mm push fit plumbing.

## EXTERNAL MIXER SHOWER POINT

The External Mixer Shower point comes complete with a Trigger Shower head assembly (shower fitting, 1.5m long shower hose and swivel control connector). Inserting the shower assembly, with a push and turn action, locks it in place and turns on the water. Temperature is adjusted by turning the connector assembly. 15mm male push fit connections on rear. Requires 60mm dia mounting hole

**DLTEXS688** External Mixer Shower Point, Trigger Handset & Hose

## AQUA-STOP WATER ECONOMISER FOR SHOWER HOSE

The Aqua-Stop connects between the shower hose and shower head of conventional 1/2" thread. With a simple push on off action to halt the water flow.

**DLTSTP150** Aqua-stop water shower economiser Chrome

## STOP WATER ECONOMISER FOR KITCHEN TAPS

The Stop water connects in place of the aerator in the end of the spout of modern taps. Any sideways contact with the wand allows water flow after contact it centres naturally to turn off.

**DLTSTP085** Stop Water kitchen tap economiser Chrome

## ANTI TWIST SHOWER HOSE SWIVEL UNION

Connects in shower hose to allow rotation of joint preventing hose knotting up.

**DLTDCC250** Anti twist shower hose swivel union Chrome



**DLT539 MIXER TAP**



**DLT 540 SINGLE TAPS**



**DLT 541 MIXER TAPS**



**DLTEXVS**



**DLT MES2W**



**DLTEXS4**



**DLTTSHC**



**DLTTSHW**



**DLTSHMCC**



**DLT3440C**



**DLTSK3420C**



**DLTSWC**



**DLTSTP150**



**DLTSTP085**



**DLTEXS688**



**DLTDCC250**



On 3/8" BSP flexi tails use **BRF3812** brass female barbs to connect 1/2" PVC hose, or **CM451213FS** to connect to 12mm push fit plumbing.

**WE NOW OFFER INSTALLATION & REPAIR SERVICE BY [SupremeTech.co.uk](http://SupremeTech.co.uk)**





# DELUXE TAPS & SHOWERS

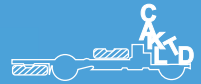

Water - Taps & Showers  
Buy securely online at Leisurelines.net

## PELIKAN SINGLE LEVER TAP

The Pelikan is elegant and modern in style. A ceramic cartridge and the use of high-quality chromium plated plastic materials guarantee quality and durability. When necessary the cartridge can be exchanged without removing the tap. The spout is 360° making the tap easy to install and use. With a microswitch the tap is suitable for submersible pumps, the switch is completely waterproof to IP67, and has a capacity of 4 amps. When used with automatic pressure switched diaphragm pumps the tap is designed to cope with 6 bar pressure. Installation hole is 33mmØ. Spout length 140mm from centre of installation hole. Hose connections for 10-12mm PVC hoses. Chrome plastic body with mat-chrome lever & spout tip. Pull out shower spout length 185mm.

- DLT5729** Pelikan single lever tap. Chrome/matt-chrome.
- DLT5728** Pelikan single lever pull out shower tap. Chrome/matt-chrome.

## TWIST SINGLE LEVER TAP

Single lever tap with neat and compact styling and ceramic cartridge for quality and reliability with ease of use. Comes in attractive colours of Matt Nickel with black trim or all chrome. Matt-nickel is a good colour match to Smev stainless range. Suitable for pressurised & microswitched water systems. Installation hole is 39mmØ. Spout length 120mm from centre of installation hole. Overall height of body 40mm. Connections suitable for 12mm & 10mm (1/2" & 3/8") flexible PVC hose. The Twist taps will not fit Smev 8000 series sinks.

- DLT575MN** Twist single lever mixer tap matt nickel
- DLT575C** Twist single lever mixer tap chrome

## KERAMIK STYLE SINGLE LEVER TAP

Very modern styled single lever tap with ceramic cartridge for quality and reliability with ease of use. Comes in attractive Matt Nickel colour. Suitable for pressurised & microswitched water systems. Installation hole is 33mmØ. Spout length 112mm from centre of installation hole. Overall height of body 40mm. Connections suitable for 12mm & 10mm (1/2" & 3/8") flexible PVC hose.

- DLT557MN** Keramik style single lever mixer tap matt nickel.

## LIVORNO PULL-OUT SHOWER TAP WITH TRIGGER HANDSET

A modern mixer tap to match Lugano & Carletta with retractable shower hose. A good choice for kitchen or bathrooms. Chrome brass construction, with trigger adjustable shut-off hand shower with 1.5m hose. Mounting hole 33mmØ. Use BRF3812 brass female barbs to connect 1/2" PVC hose, or CM451213FS to connect to 12mm push fit plumbing. Suitable for pressurised water systems only. The control knobs are chrome to match Lugano and not clear acrylic as pictured.

- DLT4343C** Livorno shower mixer, chrome metal body, chrome trigger shower

## LUGANO MIXER TAP

Very smart high quality heavy gauge chromed brass monobloc mixer tap for long lasting style and reliability. Designed to match Carletta and Livorno models. Mounting hole 27mmØ. Use BRF3812 brass female barbs to connect 1/2" PVC hose, or CM451213FS to connect to 12mm push fit plumbing. Suitable for pressurised water systems only.

- DLT4213C** Lugano mixer tap chrome, 3/8" BSP female connection
- DLT4217SC** Lugano mixer tap satin chrome, 3/8" BSP female connection

## DUCALE SINGLE LEVER MIXER TAP

Modern metal single lever domestic style tap with swiveling spout. Single lever ceramic valves for ease of use and reliability. Mounting hole 27mmØ. Spout length 190mm. Use BRF3812 brass female barbs to connect 1/2" PVC hose, or CM451213FS to connect to 12mm push fit plumbing. Suitable for pressurised water systems OR microswitched where available.

- DLT4502W** Ducale mixer, white, 3/8" BSP male connection
- DLT4502C** Ducale mixer, chrome, 3/8" BSP male connection
- DLT4503C** Ducale mixer, chrome, 12mm female JG connection **Microswitched**
- DLT4502SC** Ducale mixer, satin chrome, 3/8" BSP male connection

## ROMA SINGLE LEVER MIXER TAP (with microswitches)

Modern single lever domestic style tap with swiveling spout to similar style of Ducale and Elite. Single lever ceramic valve for ease of use and reliability. Mounting hole 33mmØ. Spout length long or short version. With hose barbs to connect 1/2" PVC hose. Suitable for microswitch or pressurised water systems. (Not pictured)

- DLT2751C** Roma single lever mixer, chrome effect, short spout
- DLT2771C** Roma single lever mixer, chrome effect, long spout

## DUCALE SINGLE LEVER MIXER FIXED SHOWER

Modern metal single lever fixed shower, having the same specifications as Ducale mixer tap. Requires Helena chrome shower hose and head kit supplied separately.

- DLT4510C** Ducale shower mixer, chrome, 3/8" BSP male connection
- DLT4511C** Ducale **Microswitched** shower mixer, chrome, 3/8" BSP male shower connection. 12mm female JG water connections
- DLT4510SC** Ducale shower mixer, satin chrome, 3/8" BSP male connection
- DLT2940C** HELENA chrome showerhead, shower rail, soap dish & 1.5m chrome hose with 3/8" female connector to valve.

## CONCEALED THERMOSTATIC SHOWER MIXER

Our Concealed Thermostatic Shower Mixer is safe for all the family to use, there is a temperature override button set at 38 degrees centigrade that makes it difficult for young children to select the highest temperatures.

Almost all of our taps and showers are manufactured from high quality Brass the finish of the product is polished Chrome which is of a very high standard. The TMV valve incorporates 180° ceramic disc headwork for utmost reliability.

Our thermostatic showers operate at their best with a hot and cold water pressure of 1.0 bar minimum pressure and above. Please ensure your chosen pump is powerful enough to allow the shower to work efficiently. We recommend use of a Shurflo or Whale universal diaphragm pump at 20psi.

Installation holes for the thermostatic mixer valve & flow control valve are 28mmØ and 42mm Ø at 70mm centres, wall thickness up to 15mm. Water connections 1/2" BSP male threads.

- DLT701703** Concealed Thermostatic Shower Mixer Chrome.



DLT5729

DLT575



DLT557MN



DLT4343C



DLT4213C



DLT4502C/DLT2771C



DLT4510C



DLT2940C



DLT701703



WE NOW OFFER INSTALLATION & REPAIR SERVICE BY [SupremeTech.co.uk](http://SupremeTech.co.uk)



## MINIMAL SINGLE LEVER KITCHEN TAP

High spec domestic style chrome single lever mixer tap with swiveling spout and ceramic valves. Base plate size 43 mmØ. Installation hole is 30mmØ. Connections 3/8" BSP male flexi tails. Suitable for use on pressurised water systems only.

**DST3010C** MINIMAL SINGLE LEVER KITCHEN MIXER CHROME



**DST3010C**



**DST3030C**

## MINIMAL SINGLE LEVER SHORT TAP

Quality chromed single lever mixer tap with spout and ceramic valves. Base plate size 31 mmØ. Installation hole is 25 mmØ. Spout length 140mm end to ctr of tap. Connections 3/8" BSP male flexi tails. Suitable for use on pressurised water systems only.

**DST3030C** MINIMAL SINGLE LEVER MIXER SHORT CHROME

## MINIMAL SINGLE LEVER SHOWER MIXER

Thru counter single lever mixer shower control with ceramic valve.. 3 connections. Hot/Cold in and Mixed out use 3/8" BSP male flexi tails. Suitable for use on pressurised water systems only. Use thru wall connection (DLTSWC pictured page 31) to connect mixer to suitable shower hose and head set.

**DST3050C** MINIMAL SINGLE LEVER SHOWER MIXER

**DLTSWC** THRU WALL WATER CONNECTION FOR SHOWERS (See Page 31)



**DST3050C**

## ESSENCE RANGE OF TAPS SHOWERS & ACCESSORIES

### Essence - Big on style small on size

New small footprint tap range with the 'essence' of design. Quality chromed brass domestic style single lever mixers for Kitchen, Basin or shower. Available with a matching range of accessories.

Single lever chrome mixer with long swiveling spout. Base plate size 43 mmØ. Installation hole is 25 mmØ. Connections 3/8" BSP male flexi tails. Suitable for pressurised water systems only. Spout length 190mm.

**DST8010C** ESSENCE SINGLE LEVER MIXER LONG CHROME



**DST8010C**

Single lever chrome mixer with short spout. Base plate size 32 mmØ. Installation hole is 25 mmØ. Connections 3/8" BSP male flexi tails. Suitable for pressurised water systems only. 120mm spout.

**DST8030C** ESSENCE SINGLE LEVER MIXER SHORT CHROME



**DST8030C**

Tall single lever chrome mixer with short swiveling spout. Ideal for the kitchen tap is 225mm high. Base plate size 32 mmØ. Installation hole is 25 mmØ. Spout 135mm. Connections 3/8" BSP male flexi tails. Suitable for pressurised water systems only.

**DST8035C** ESSENCE TALL SINGLE LEVER MIXER SHORT



**DST8035C**

Matching single lever chrome shower mixer control. With 3/8" BSP connection for shower hose. Base plate size 32mmØ. Installation hole is 25 mmØ. Connections 3/8" BSP male flexi tails. Suitable for pressurised water systems only. Any of our other shower kits will fit this 3/8" BSP connection.

**DST8050C** ESSENCE SINGLE LEVER SHOWER MIXER

**DLTSK8115CS** MINIMAL SHOWER KIT & RISER BAR CHROME AND SATIN CHROME (See Page 34)



**DST8050C**



**DST3515C**

## ESSENCE ACCESSORIES

A range of matching Essence accessories are available on our website or ask for the supplementary leaflet.

## MARIN MINIMAL ACCESSORIES

Range of matching Marin Minimal chrome accessories of reduced size perfectly suited to accessorise any bathroom with style.

**DST35050005C** MARIN BATHROOM GLASS AND HOLDER CHROME

**DST35100010C** MARIN SOAP DISH AND HOLDER CHROME

**DST355050C** MARIN PUMP SOAP DISPENSER & HOLDER CHROME

**DST3515C** MARIN DOUBLE COAT HOOK CHROME

**DST3535C** MARIN TOILET ROLL HOLDER CHROME

**DST3525C** MARIN 30CM TOWEL RAIL CHROME

Wall mounted toilet brush holder with specially developed shaped rubber brush for effective cleaning while providing long lasting service.

**DST3540C** MARIN TOILET BRUSH & HOLDER CHROME



**DST35100010C**

**DST3525C**



**DST3535C**



**DST35050005C**



**DST355050C**



**DST3540C**

On 3/8" BSP flexi tails use BRF3812 brass female barbs to connect 1/2" PVC hose, or CM451213FS to connect to 12mm push fit plumbing.

**WE NOW OFFER INSTALLATION & REPAIR SERVICE BY [SupremeTech.co.uk](http://SupremeTech.co.uk)**



**0844 414 2324**



**0844 414 2425**



# ULTIMATE TAPS & SHOWERS

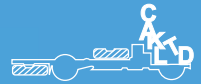

Only top quality materials are used in our ultimate & designer taps. Materials which take the stresses and strains of a long product life.

## WAVE SWAN SINGLE LEVER MIXER TAP

Stylish 'wave' shaped control lever high quality chromed brass single lever mixer tap. Heavy gauge chromed brass for long lasting style and ceramic cartridge for reliability. Swan neck faucet swivels 360°. Base plate size 50 mmØ, Installation hole is 35 mmØ. Spout length 170mm from centre of installation hole. Connections 3/8" BSP male flexi tails. Suitable for pressurised water systems only.

**DLTWSMC** WAVE SWAN SINGLE LEVER MIXER TAP



**DLTWSMC**



**DLTWBSNC**

## WAVE SWAN BASIN SINGLE LEVER MIXER

A new addition to our stylish 'wave' range the basin tap is a single lever chromed brass design with ceramic cartridge valve.

Base plate size 56 mmØ, Installation hole is 35 mmØ. Spout length 130mm from centre of installation hole. Connections 3/8" BSP male flexi tails. Suitable for pressurised water systems only.

**DLTWBSNC** WAVE SWAN BASIN SINGLE LEVER MIXER TAP

## SINGLE LEVER MIXER PULL OUT SHOWER

Streamlined design chromed brass body with ceramic cartridge valves. Pull out chromed shower head with push button adjustable spray head (chrome) and 1.8 metre flexible grey hose. Base plate size 55 mmØ, Installation hole is 35 mmØ. Connections 3/8" BSP male flexi tails. Suitable for pressurised water systems only.

**DLTLPSC** SINGLE LEVER MIXER PULL OUT CHROME SHOWER



**DLTLPSC**



**DLT3470C/DLT3481C**

## SINGLE LEVER MIXER TAP

Very smart single lever tap with ceramic cartridge for quality and reliability with ease of use. Chromed brass body for quality and long life. Long and short spout available as well as basin design. Base plate size 45 mmØ, Installation hole is 32mmØ. Spout length from centre of installation hole: **DLT3451C** short 150mm, **DLT3470C** Medium 190mm, **DLT3481C** long 240mm, **DLT3831C** basin 110mm. Connections 3/8" BSP male flexi tails. Suitable for pressurised water systems only.

- DLT3451C** LUX SINGLE LEVER MIXER TAP SHORT 150mm SPOUT
- DLT3470C** SINGLE LEVER MIXER TAP MEDIUM 190mm SPOUT
- DLT3481C** SINGLE LEVER MIXER TAP LONG 240mm SPOUT
- DLT3831C** LUX SINGLE LEVER BASIN MIXER CHROME



**DLT3451C**



**DLT3451C**

## SINGLE LEVER MIXER SHOWER CONTROL

Modern single lever fixed shower, having the same specifications as Lux mixer tap. High quality chromed brass construction. Requires Helena or Minimal chrome shower hose and head kit supplied separately.

Base plate size 45 mmØ, Installation hole is 32 mmØ. Connections 3/8" BSP male flexi tails. Suitable for pressurised water systems only.

- DLT3660C** SINGLE LEVER SHOWER CONTROL
- DLT3661C** LUX SINGLE LEVER SHOWER CONTROL



**DLT3661C**

## TETRA MONOBLOC MIXER

Quality chromed brass domestic style monobloc mixer with swiveling spout. Base plate size 45 mmØ, Installation hole is 25 mmØ. Connections 3/8" BSP male flexi tails. Suitable for pressurised water systems only.

**DLTTMC** TETRA MONOBLOC CHROME MIXER

## SHOWER KIT MINIMAL

Chrome Shower head with flexible jets to prevent the buildup of limescale. Chrome hose is 150cm long combined with Minimal styled riser bar. 3/8" BSP female connection.

**DLTSK8115C** MINIMAL SHOWER KIT WITH RISER BAR CHROME

**DLTSK8115CS** MINIMAL SHOWER KIT WITH RISER BAR SATIN CHROME



**DLTSK8115C**



**DLTTMC**

## SHOWER WALL BRACKET

Wall mounting bracket for locating shower head on wall. Available in 2 versions. SHC manufactured in chromed ABS, SBC made from chromed brass

- DLTSHC** FIXED WALL BRACKET FOR SHOWER HEAD
- DLTSBC** ADJUSTABLE ANGLE WALL BRACKET FOR SHOWER HEAD



**DLTSHC**



**DLTSBC**

## COMPACT PULL OUT SHOWER SINGLE LEVER MIXER TAP

Smart styled single lever ceramic cartridge mixer pullout shower tap with trigger shower handset. Simply squeeze the trigger for water to flow as and when you require or flip up the lever to lock at 90 degrees and the water is fully on. Connections 3/8" BSP male flexi tails. Suitable for pressurised water systems only. Spout length 135mm approx.

**DLT3400C** SINGLE LEVER MIXER PULL OUT CHROME SHOWER



**DLT3400C**

## CHROME TOWEL RAIL

Smart high quality chromed brass towel rail 310mm overall length

**DLTTRLC** CHROMED BRASS TOWEL RAIL 310mm



**DLTTRLC**

On 3/8" BSP flexi tails use BRF3812 brass female barbs to connect 1/2" PVC hose, or CM451213FS to connect to 12mm push fit plumbing.

WE NOW OFFER INSTALLATION & REPAIR SERVICE BY [SupremeTech.co.uk](http://SupremeTech.co.uk)

Water - Taps & Showers

Buy securely online at [Leisurelines.net](http://Leisurelines.net)

Only top quality materials are used in our ultimate & designer taps. Materials which take the stresses and strains of a long product life.

### NEW LAUSANNE FLIP CHROME FOLDING MIXER

The LAUSANNE FLIP folding faucet mixer tap is elegant and modern in style. Produced from heavy gauge chromed metal for long lasting reliability. Installation hole is 33mmØ. Connections 3/8" BSP male tails. Suitable for pressurised water systems only. Suitable for installation in SMEV folding glass sinks. Tap is 40mm high when folded.

**DLTFLIP** LAUSANNE FLIP CHROME FOLDING MIXER

### MARINE FOLDING SINGLE TAP

Marine high quality chromed brass single tap. Heavy gauge chromed brass for long lasting style. Installation hole is 16mmØ. Spout length 140mm from centre of installation hole. Connection 3/8" BSP male thread. Suitable for pressurised water systems only. Suitable for installation in SMEV folding glass sinks. Tap is 39mm high when folded

**DLTMSC** MARINE SINGLE CHROME TAP

### MARINE FOLDING MIXER TAP

Marine high quality chromed brass mixer tap. Heavy gauge chromed brass finish complements the design. Installation holes 2 x 16 mmØ at 60mm centres. Spout length 140mm from centre of installation hole. Connections 2 x 3/8" BSP male thread. Suitable for pressurised water systems only. Suitable for installation in SMEV folding glass sinks. Tap is 39mm high when folded

**DLTMMC** MARINE MIXER CHROME TAP

### STYLE SINGLE LEVER MIXER TAP

Very smart single lever tap with ceramic cartridge for quality and reliability with ease of use. Chromed brass body for quality and long life. Installation hole is 26 mmØ. Spout length 140 mm from centre of installation hole. Connections 3/8" BSP male flexi tails. Suitable for pressurised water systems only. Suitable for installation in SMEV folding glass sinks. Tap is 37mm high when folded

**DLTSTMIN** STYLE SINGLE LEVER MIXER

### LUX SINGLE LEVER PILLAR MIXER

Chrome single lever mixer with curved faucet, which swivels 360°, and ceramic cartridge valves for smooth operation. Base plate size 50 mmØ, Installation hole is 38 mmØ. Spout length 175 mm from centre of installation hole. Connections 3/8" BSP male flexi tails. Suitable for pressurised water systems only.

**DLTLPM** LUX CHROME PILLAR MIXER

### SINGLE PILLAR TAP

Smart design chromed brass body with 360° swivel faucet. Reliable and easy to install cold tap. Base plate size 38 mmØ, Installation hole is 20 mmØ. Connection 1/2" BSP male flexi tails. Suitable for pressurised water systems only.

**DLTPTC** PILLAR SINGLE CHROME TAP

### COMPACT SINGLE TAP

Simple compact design chromed brass body single tap with folding spout. Reliable and easy to install cold tap. Base plate size 28 mmØ, Installation hole is 16 mmØ. Connections 3/8" BSP male inlet. Suitable for pressurised water systems only.

**DLTCSC** COMPACT SINGLE CHROME TAP

### COMPACT MIXER TAP

Simple compact design chromed brass body mixer tap with folding spout. Reliable and easy to install mixer tap. Base plate 2 x 28mmØ at 86mm centres, Installation holes are 2 x 16mmØ. Connections 3/8" BSP male inlets. Suitable for pressurised water systems only.

**DLTCMC** COMPACT MIXER CHROME TAP

### COMPACT MIXER SHOWER TAP

Simple compact design chromed brass body mixer shower tap with 3/8" BSP shower connection. Requires Helena or Minima chrome shower hose and head kit supplied separately. Or add a **DLTSH150GN** hose from below and a trigger handset for a simple controllable shower. Reliable and easy to install shower tap. Base plate 2 x 28mm at 86mm centres, Installation holes are 2 x 16mmØ. Connections 3/8" BSP male inlets. Suitable for pressurised water systems only.

**DLTCSMC** COMPACT SHOWER MIXER CHROME

### GREY NYLON SHOWER HOSE

Good quality flexible grey nylon shower hoses with chrome end connections.

**DLTSH150GN** GREY SHOWER HOSE 150CM 1/2"C & 3/8" Fem chrome ends

**DLTSH2350GN** GREY SHOWER HOSE 200CM 3/8" Fem & 15/1 Male Chrome ends

### CHROME SHOWER HOSE

Good quality flexible chrome shower hoses with chrome end connections.

**DLTSH1501212C** CHROME SHOWER HOSE 150CM 1/2"C Fem & 1/2" Female chrome ends

**DLTSH2001212C** CHROME SHOWER HOSE 150CM 1/2"C Fem & 1/2" Female chrome ends

**DLTSH150C** CHROME SHOWER HOSE 150CM 1/2"C Fem & 3/8" Female chrome ends

**DLTSH200C** CHROME SHOWER HOSE 200CM 1/2"C Fem & 3/8" Female chrome ends

### SPARE FLEXIBLE TAP TAILS

**DLTTL20** SPARE 20CM TAIL STEEL BRAIDED 3/8BSP MALE.

**DLTTL40** SPARE 40CM TAIL STEEL BRAIDED 3/8BSP MALE.

**DLTTL25** SPARE 25CM WHITE BRAIDED PVC TAIL 3/8BSP MALE.

**DLTTL30** SPARE 30CM WHITE BRAIDED PVC TAIL 3/8BSP MALE.

On 3/8" BSP flexi tails use BRF3812 brass female barbs to connect 1/2" PVC hose, or CM451213FS to connect to 12mm push fit plumbing.



**DLTFLIP**



**DLTMMC**



**DLTMSC**



**DLTLPM**



**DLTSTMIN**



**DLTCSC**



**DLTPTC**



**DLTCSMC**



**DLTCMC**



**DLTSH1501212C**



**DLTSH150GN**



**DLTSH2350GN**

WE NOW OFFER INSTALLATION & REPAIR SERVICE BY [SupremeTech.co.uk](http://SupremeTech.co.uk)



0844 414 2324



0844 414 2425



# SMEV BUILT IN HOBS AND SINKS



Kitchen - SMEV  
Buy securely online at [Leisurelines.net](http://Leisurelines.net)

**2 BURNER HOB NO GRILL**  
380mm x 280mm  
STAINLESS



S2212 Hob  
S2232 Hob + piezo ignition

**2 BURNER HOB WITH GRILL**  
420mm x 370mm  
STAINLESS



S1242 Hob  
S1262 Hob + 12 V ignition

**SINGLE BURNER COMBINATION 600mm X 350mm STAINLESS**



S911677L Single burner compact stainless combo unit 100 mm deep bowl.

**2 BURNER MINI COMBINATION UNIT 490 x 460mm STAINLESS**



S0927R RIGHT HAND  
S0927L LEFT HAND (PICTURED)

**2 BURNER COMBINATION UNIT 800mm x 420mm STAINLESS**



S09218042R 800 x 420 RH (PICTURED)  
S09218042L 800 x 420 LH

**2 BURNER MIDI COMBINATION UNIT 600 x 420mm STAINLESS**



S917R 600 x 420 RH  
S917L 600 x 420 LH (PICTURED)

**2 BURNER 911CV NARROW COMBINATION UNIT STAINLESS**



S9118032L 800 x 325 155mm deep  
Only available Left Hand

**RECTANGULAR SINK OR DRAINER STAINLESS**



S0930 380 x 280 145 DEEP  
S0938 380 x 280 45 DEEP

**SQUARE SINK OR DRAINER STAINLESS**



S0932 380 x 380 145 DEEP  
S0910 370 x 370 125 DEEP  
S0912 370 x 370 45 DEEP

**RECTANGULAR SINK AND LONG DRAINER UNIT STAINLESS**



S0934 650 x 380 145 DEEP

**SQUARE SINK AND SHORT DRAINER UNIT STAINLESS**



S0936 590 x 370 125 DEEP

CODE L OR LH DESIGNATES THE HANDING OF THE SINK AS ON LEFT HAND END OF UNIT. (R or RH = RIGHT HAND)

**NEW** range of stylish Stainless Steel inset sinks. High grade marine quality manufactured.



CLA1420 L 382 x W 265 x D 130



CLA1440 387 x 155 D ROUND SINK WITH ANGLED BASE



CLA1442 OVAL BOWL L510 X W 454 X 161D WITH 94mm WIDE LIP TO REAR FOR TAP



CLA1400 320 X 260 X 150D  
CLA1404 320 X 170 X 150D  
CLA1401 355 X 260 X 150D  
CLA1402 350 X 320 X 150D



CLA1410 290 DIA x 120 D  
CLA1411 330 DIA x 150 D  
CLA1412 390 DIA x 150 D



CLA1416 285 DIA X 180 D  
CLA1417 330 DIA X 180 D  
CLA1418 385 DIA X 150 D  
CLA1419 455 DIA X 150 D  
CLA1421 420 DIA X 180 D



Tempered Glass surface mounted bowl use with CGLP1699 popup waste.  
CGB1489 280mm  
CGB1499 360mm



Semi spherical stainless steel sink coated white.  
CLB1413 290 DIA X 120 D mm  
CLB1414 330 DIA X 150 D mm  
CLB1415 390 DIA X 150 D mm



CLA1441 L 510 x W 390 x D 161



CLP16001601 STRAIGHT 20MM



CLP1611 ANGLED 25MM  
CLP1620 ANGLED 20MM



CLP1612 THREAD REDUCER 1 1/2 TO 1 1/4



CLP1613 REDUCER 1 1/4 TO 32mm Rigid waste

WE NOW OFFER INSTALLATION, GAS SAFETY TEST AND REPAIR SERVICE BY [SupremeTech.co.uk](http://SupremeTech.co.uk)





## SMEV 7000 - 8000 SERIES INTEGRATED FLUSH FITTING HOBS, SINKS AND COMBINATION UNITS WITH GLASS COVERS C.A.K. HIGHLY RECOMMENDS THIS PRODUCT.

The built in flush fitting integral hinged glass cover is available in Black. 8000 series is a high quality range with crisp modern styling flush fitting integrated combination units in matt stainless steel. Glass lids are ideal for extra work surface. Glass cover must be lifted up when gas hob burners are ignited. 8000 series sinks require shallow folding taps no more than a maximum of 43mm high. Such as the DLT539 matt nickel mixer tap or for cold water only use DLT540C matt nickel single tap. See pages 28-35 in catalogue. Sinks do not have hole drilled for tap except S8123. This allows choice between the new taps on pages 28-35. With 8000 series installations if a grill is required a SG555 mini grill or 200 series oven should be installed see page 41-43. A matching sink top waste bin STWB is available see page 44

### 8300 INTEGRATED COMBINATION UNITS

The 8300 series integrated combination units build on the quality and style of the 8000 series. The combined units add a new design and style focus to the modern kitchen installation. Sizes 680mm wide x 440mm deep. Bowl Depth 135mm Total height 150mm. **Taps for illustration and must be purchased separately.**

- S8302** 2 Burner hob with round sink combination unit with integral black glass cover
- S8322** 2 Burner hob + 12 V Ignition. with round sink combination unit with integral black glass cover
- S8303** 3 Burner hob with round sink combination unit with integral black glass cover
- S8323** 3 Burner hob + 12 V Ignition. with round sink combination unit with integral black glass cover.

### INTEGRATED SINK & DRAINER UNIT

Smart integrated Sink and Drainer Unit to match the style of the 8300 series hobs. Dimensions 680 wide x 440mm deep. Depth into bowl 153mm. **Taps for illustration and must be purchased separately.**

- S8306** Integrated sink and drainer unit with black glass cover.
- S8306G** Integrated sink and drainer unit with silver grey glass cover.

- S8306NR** Integrated RH sink and drainer unit without glass cover.
- S8306NL** Integrated LH sink and drainer unit without glass cover.

### SMEV SQUARE BACK ROUND SINK

- S8206** Integrated round sink unit with independent integral black glass cover. 420mm wide x 430mm deep. Bowl Depth 145mm. With 40mm hole for tap installation.

### INTEGRATED COMBINATION UNITS

The integrated combination units build on the quality and style of the 8000 series. The combined units add a new design and style focus to the modern kitchen installation.

- S7123** 3 Burner hob + 12 V Ignition. with rectangular sink combination unit with independent integral black glass covers. 800mm wide x 460mm deep. Bowl Depth 135mm.
- S8123** 3 Burner hob + 12 V Ignition. with round sink combination unit with independent integral black glass covers. With hole for tap between covers. 970mm wide x 430mm deep. Bowl Depth 145mm. **PLEASE NOTE DLT539 TAP DOES NOT FIT THIS UNIT**

### SMEV HOB AND SINK SET

NEW Special split version of 8123 allowing independent placing of the two components or mix and match with other items in the range.

- S8203** 3 Burner hob with integral black glass cover 520mm wide x 430mm deep
- S8206** Integrated round sink unit with independent integral black glass cover. 420mm wide x 430mm deep. Bowl Depth 145mm. With tap hole suitable for DLT575

### NEW NARROW INTEGRATED COMBINATION UNIT

The NEW 9222 narrow integrated combination units allow the style and quality of the 8000 series to be installed in more compact campers. Sizes 900mm long x 370mm wide. Bowl Depth 135mm Total height 150mm.

- S9222LH** 2 Burner hob with piezo Ignition and left hand sink narrow combination unit with twin integral black glass covers
- S9222RH** 2 Burner hob with piezo Ignition and right hand sink narrow combination unit with twin integral black glass covers

### INTEGRATED GLASS SURFACE 3 BURNER HOBS

Inline 3 burner unit with 12v electronic ignition. Size 590mm wide x 350 deep, height 160mm.

- S8423GL** Integrated Glass Surface inline 3 burner + 12v ign hob unit with black glass cover.
- 8000 Series 3 burner Hob with new Integrated Glass Surface & 12v ign. Size 560mm wide x 440 deep. Hob is sized to match the S8005 sink unit.
- S8023GL** Integrated Glass Surface 3 burner + 12v ign hob unit with black glass cover

### CRAMER 3 BURNER HOB WITH GLASS & INTEGRATED LIDS

The hob has 2 integrated heat-resistant safety glass lids and easy-to-clean heat-resistant safety glass surface. The chromed pan supports are detachable and controls are recessed. Dimensions: width 485.5 x Depth 485.5 mm Enamelled burner caps Safety ignition system

- DCRCE08DF** CRAMER 3 BRNR GLASS HOB + GLASS LID



8302



8303



8206 SINK



8306 Also available no glass



7123



8203 HOB

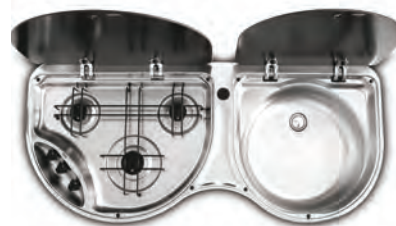

8123



S8023GL



9222RH



DCRCE08DF



S8423GL

**IMPORTANT NOTE: ALL GAS APPLIANCES MUST BE INSTALLED BY A QUALIFIED GAS ENGINEER. IF APPLIANCE IS DIY INSTALLED THE GAS INSTALLATION MUST BE INSPECTED FOR SAFETY BY A COMPETENT PERSON BEFORE USE.**

**All SMEV products are fitted with FFD flame failure cut off devices as standard**

**WE NOW OFFER INSTALLATION, GAS SAFETY TEST AND REPAIR SERVICE BY [SupremeTech.co.uk](http://SupremeTech.co.uk)**





# SMEV BUILT IN HOBS AND SINKS



## SMEV 8000 SERIES INTEGRATED FLUSH FITTING HOBS AND SINKS WITH GLASS COVERS



### SINK & COVER

**S 8006 420mm x 440mm**  
STAINLESS STEEL  
**S8006** BLACK GLASS  
**S8006G** SILVER GREY GLASS

Tap shown as suggestion only. To be ordered separately, see pages 30 to 35.

**DRAINER & COVER**  
**420mm x 440mm x 46mm Deep**  
**S8010** BLACK GLASS  
**S8010G** SILVER GREY GLASS



### SINK & COVER

**S-8005 420mm x 370mm**  
STAINLESS STEEL  
**S8005** BLACK GLASS  
**S8005G** SILVER GREY GLASS

Tap shown as suggestion only. To be ordered separately, see pages 30 to 35.

**DRAINER & COVER**  
**420mm x 370mm x 46mm Deep**  
**S8011** BLACK GLASS  
**S8011G** SILVER GREY GLASS



### 3 BRN HOB + COVER

**S 8003 560mm x 440mm**  
STAINLESS STEEL  
BLACK GLASS LID  
**S8003** Hob  
**S8023** Hob + 12V ignition

SILVER GREY GLASS LID  
**S8003G** Hob  
**S8023G** Hob + 12V ignition



### 2 BRN HOB + COVER

**S-8002 480mm x 370mm**  
STAINLESS STEEL  
BLACK GLASS LID  
**S8002** Hob  
**S8022** Hob Piezo ignition

SILVER GREY GLASS LID  
**S8002G** Hob  
**S8022G** Hob Piezo ignition

### MARINE PANHOLDER FOR 8000 SERIES.

Pan holder pair for attachment to 8002 pan supports  
**SAC538** MARINE PANHOLDER FOR S-8002 SERIES



### INTEGRATED ROUND 3 BURNER HOB AND MATCHING SINK

Smart integrated Round Sink Unit in the style of the 8000 series with matching round 3 burner hob with 12v electronic ignition. Choice of taps that stow away under the glass lid is the same as other 7-8000 units.

**S7306** Integrated round sink unit with black glass cover. Dimensions 420mmØ, Sink depth into bowl 148mm.  
**S7223** Integrated round 3 burner hob + 12v ign & black glass cover. Dimensions 480mmØ, height 108mm.

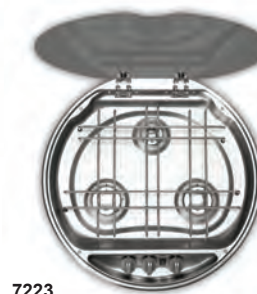

7223



7306

### INTEGRATED INLINE 3 BURNER HOB

Another new style hob this is a narrow inline 3 burner unit with 12v electronic ignition. Size 590mm wide x 350 deep, height 141mm.

**S8463** Integrated inline 3 burner + 12v ign hob unit with black glass cover.



8463



9003

### INTEGRATED TRICORN 3 BURNER HOB

Yet another new hob is a stylish triangular 3 burner unit with integrated glass cover. Dimensions 490mm wide x 490 deep.

**S9003** Integrated Tri-corn 3 burner hob unit with black glass cover.

### INDIVIDUAL SINGLE BURNER HOB

A new simple and smart single burner hob with piezo ignition. Install it on its own in smaller kitchens or fit more side by side or offset to create a feature. Size 320mm x 240mm

**S8621RP** 1 LARGE 2.2Kw BURNER HOB + PIEZO IGNITION  
**S8621SR** 1 MEDIUM 1.8Kw BURNER HOB + PIEZO IGNITION  
**S8621AU** 1 SMALL 1Kw BURNER HOB + PIEZO IGNITION

### ROUND ABOVE COUNTERTOP BOWL

A very stylish new stainless steel bowl. High quality heavy gauge mirror polished stainless steel.

**SELK9510** Above countertop bowl. Size 290mmØ x 120mm above countertop. Use CGLP1699 waste



8621

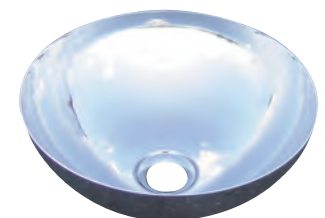

SELK9510

**IMPORTANT NOTE: ALL GAS APPLIANCES MUST BE INSTALLED BY A QUALIFIED GAS ENGINEER. IF APPLIANCE IS DIY INSTALLED THE GAS INSTALLATION MUST BE INSPECTED FOR SAFETY BY A COMPETENT PERSON BEFORE USE. ALL SMEV PRODUCTS ARE FITTED WITH FFD FLAME FAILURE CUT OFF DEVICES AS STANDARD**

WE NOW OFFER INSTALLATION, GAS SAFETY TEST AND REPAIR SERVICE BY [SupremeTech.co.uk](http://SupremeTech.co.uk)





## 8800 INTEGRATED COMBINATION UNITS

The integrated combination units build on the quality and style of the 8000 series. The combined units add a new design and style focus to the modern kitchen installation. Drainer plate and waste bowl supplied with S8821L & R. Tap not included use DLT539

- S8821L** 1 Burner hob +Piezo Ignition & left hand sink combination unit with integral black glass cover & waste bowl. 525mm wide x 421mm deep.
- S8821R** 1 Burner hob +Piezo Ignition & Right hand sink combination unit with integral black glass cover & waste bowl. 525mm wide x 421mm deep.
- S8822L** 2 Burner hob +Piezo Ignition (Left hand large burner) with integral black glass cover. 525mm wide x 421mm deep.
- S8822R** 2 Burner hob +Piezo Ignition (Right hand large burner) with integral black glass cover. 525mm wide x 421mm deep.



S8821L



S8821R



S8822L



S8822R

## 8800 SERIES ACCESSORIES

Specific handed drainer plate for 8800 series, will also fit hobs. Fits over single burner on combo units or small burner on hobs (Drainer plate is included with S8821) See picture right showing drainer plate and waste bowl fitted.

- S88AC620** Spare waste bowl
- S88001** DRAINER COVER LH
- S88002** DRAINER COVER RH



**SMGPAN**  
Smev non-stick grill pan with detachable handle.



**S0945** Double sink unit in Stainless Steel.  
Size 575mm wide x 370 deep. Depth into bowl 110mm



**ROUND SINK**  
**S0928** Sink 400mmØ 130 deep  
**S0933** Sink 400mmØ 145 deep



**ROUND DRAINER**  
**S0929** Drainer 400mmØ 45 deep

## SMEV HARDWOOD CUTTING BOARD



CODE	FOR MODELS
SCB570	Round 928,929,933

CODE	FOR MODELS
SCB571	902, 912, 936, 937, 6000
SCB578	930, 938
SCB581	SERIES 8000

## SMEV DISH RACKS



CODE	SIZE
SDR702	340 x 240 mm



CODE	SIZE
SDR704	330 x 230 mm

## SMEV SINK WASTES FOR SMEV UNITS

Special waste designed for Smev sink units. Waste has smaller rim diameter on stainless top to fit into recess around pressed waste hole in the Smev product range. These wastes will fit as replacements on most continental designed sink units. All Smev sinks supplied by us that require a waste come with SVSW9020 included within the box.

- SVSW18020** SMEV S/S STRAIGHT WASTE FOR 20MM (3/4") HOSE (A)
- SVSW18025** SMEV S/S STRAIGHT WASTE FOR 25MM (1") HOSE (A)
- SVSW55725** SMEV S/S 2 OUTLET TRAP WASTE 25MM (3/4") HOSE 1 OUTLET CAPPED (REMOVABLE) (C)
- SVSW56020** SMEV S/S 1 OUTLET TRAP WASTE 20MM (3/4") HOSE
- SVSW9020** SMEV S/S ANGLED WASTE FOR 20MM (3/4") HOSE (B)
- SVSW9025** SMEV S/S ANGLED WASTE FOR 25MM (1") HOSE (B)
- SVSWPLUG** SPARE PLUG FOR SMEV SINK WASTE 37MM Ø



**IMPORTANT NOTE: ALL GAS APPLIANCES MUST BE INSTALLED BY A QUALIFIED GAS ENGINEER. IF APPLIANCE IS DIY INSTALLED THE GAS INSTALLATION MUST BE INSPECTED FOR SAFETY BY A COMPETENT PERSON BEFORE USE. ALL SMEV PRODUCTS ARE FITTED WITH FFD FLAME FAILURE CUT OFF DEVICES AS STANDARD**

WE NOW OFFER INSTALLATION, GAS SAFETY TEST AND REPAIR SERVICE BY [SupremeTech.co.uk](http://SupremeTech.co.uk)



0844 414 2324



0844 414 2425



Buy securely online at [Leisurelines.net](http://Leisurelines.net)

Designed to complete SMEV's Motorhome product range, the ovens offer the same cooking performance and gas marks as a standard household oven. In-depth research results in uniform heat distribution inside the oven and low gas consumption.

### MOTORHOME & MARINE CURVED GLASS DOOR OVEN

The very stylish new curved glass door oven range from smev is designed to complement the newer style refrigerators with modern curved doors. Available in 20 Litre and 30 Litre cavity sizes with left or right hand hinged door. The 291 & 391 ovens are designed with exterior exhaust venting to the roof. Additional venting components will be required. See below. The ovens are built to marine use specifications for installation in watercraft. Left hand versions pictured.

### 30 LITRE CURVED GLASS DOOR OVEN

Size: Width 525mm x Depth 422mm x Height 438mm without door.

**SOV391GTLIL** 391 Curved glass 30 Litre Oven, Thermostat, Grill, Interior Lamp & 12v Electronic Ignition with left hand hinged door.

**SOV391GTLIR** 391 Curved glass 30 Litre Oven, Thermostat, Grill, Interior Lamp & 12v Electronic Ignition with right hand hinged door.

### 20 LITRE CURVED GLASS DOOR OVEN

Size: Width 525mm x Depth 422mm x Height 315mm without door.

**SOV291GTLIL** 291 Curved glass 20 Litre Oven, Thermostat, Grill, Interior Lamp & 12v Electronic Ignition with left hand hinged door

**SOV291GTLIR** 291 Curved glass 20 Litre Oven, Thermostat, Grill, Interior Lamp & 12v Electronic Ignition with right hand hinged door

### ROOF CHIMNEY COMPONENTS FOR 291 & 391 OVENS

Components for safe installation of oven roof flue assembly. UR ducting is used as a heat protection shield over-sleeving the stainless exhaust flue pipe.

**GMTRFT** Roof flue cowl

**GMTF50** 50mm Stainless flexible exhaust flue tube per mtr

**G-UR** Over duct for exhaust pipe per mtr

### NEW SMEV 433 NARROW COOKER & MARINE VERSION

NEW narrow cooker with 3 Burner glass surface hob, thermostatic oven with grill & 12 volt ignition to all burners. Reduced width dimensions for easier installation or to fit in replacement of existing ovens.

Dimensions approx 445w x 463h x 474d

**SC433** 3 burner glass hob cooker with oven, grill, ignition and integrated glass cover

**SC433M** 3 burner glass hob Marine cooker with oven, grill & ignition, with gimbals and pan support

### NEW FLUSH FIT SMEV MOONLIGHT COOKTOP

The S8723 is a new flush fitting 3 Burner narrow glass integrated hob top with 12v ignition. Dimensions overall 520 x 380 x 59mm

**S8723** 3 BURNER SMEV GLASS HOB



SOV291GTLIL

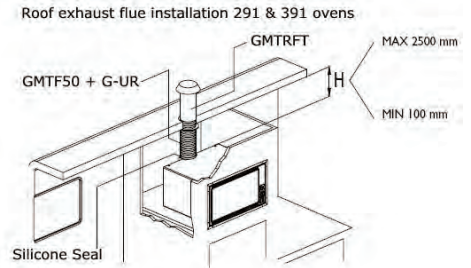

SC433



SC433



**S8723  
MOONLIGHT  
COOKTOP**



SC433



**SC433M NARROW  
MARINE COOKER**

### NEW OVEN TURNTABLE FOR EVEN COOKING

New from SMEV is a turntable shelf for the 20 & 30 litre ovens. Designed to make even temperature cooking the norm for a gas oven. Allowing food to remain cooking without the need for constant opening and turning of the food to get the cooking even. Great for pizzas roasts and cakes etc.

Available to order the turntable shelf connects to the integrated motor in the oven

### 20 LITRE OVEN WITH HINGE DOWN DOOR & TURNTABLE

**SOV20GTLITT** OF211FGT 20 litre oven + thermostat with grill built in + 12v interior lamp and 12 v ignition to oven and grill burners. Integrated turntable shelf.

### 30 LITRE OVEN WITH HINGE DOWN DOOR & TURNTABLE

**SOV30GTLITT** OF311FGT 30 litre oven + thermostat with grill built in + 12v interior lamp and 12 v ignition to oven and grill burners. Integrated turntable shelf.



New oven Turntable



New oven turntable

**IMPORTANT NOTE: ALL GAS APPLIANCES MUST BE INSTALLED BY A QUALIFIED GAS ENGINEER. IF APPLIANCE IS DIY INSTALLED THE GAS INSTALLATION MUST BE INSPECTED FOR SAFETY BY A COMPETENT PERSON BEFORE USE.**

**WE NOW OFFER INSTALLATION, GAS SAFETY TEST AND REPAIR SERVICE BY [SupremeTech.co.uk](http://SupremeTech.co.uk)**





The Smev range of kitchen appliances are of the highest quality in design, construction and usability. They have many advanced features, styled to please the eye with sweeping curves and smooth profiles Smev units are renown for providing great satisfaction during their use, while being an easy to fit long lasting & trouble free product. Designed to complete SMEV's product range, the ovens & cookers offer the same cooking performance and gas marks as a standard household oven. In-depth research results in uniform heat distribution inside the oven and low gas consumption. The oven & cooker ranges come with cool touch ventilated double glazed doors for safety; internal glass within door is easily removed for cleaning. Stainless ovens have ultra modern smart semi-mirror glass doors. The ovens are insulated and fully externally clad as standard making installation easier. All Smev ovens have rounded easy clean interiors. Ovens and cookers are not freestanding and must be fitted into furniture. Ovens and hobs run on both Butane and Propane gas at 28, 30 & 37 mbar pressure. Ignition and lamps available 12 volt dc only (optional extras where available).

### SMEV 555 MINI GRILL

Complete grill and casing with glass hinge down door. Door must be open when grill is in use. This is not a small oven it is an independent build in grill. The 555 mini grill cannot be used freestanding it must be built in.

Size: W 485mm, D 410mm, H 240mm. Build in W 486 x D 460 X H 254mm

**SG555** 555 BUILD IN GRILL

**SG555PI** 555 BUILD IN MINI GRILL with Piezo ignition

**SG555PIL** 555 BUILD IN MINI GRILL with Piezo ignition & Interior lamp

### SMEV COOKERS WITH HINGE DOWN DOOR

Incorporating all the quality features of Smev ovens and hobs. The cookers allow all features to be installed in one unit. Ideal for restricted space kitchen areas.

Size: W 530mm, D 415mm, H 390mm. Build in W 500 x D 450 X H 393mm

**SH40VGT** O311FGT 4 burner hob + oven + thermostat with grill built in

**SH40VGTLI** O311FGT 4 burner hob + oven + thermostat with grill built in +12v interior lamp and 12 v ignition to oven and grill burners.

### 30 LITRE OVEN WITH HINGE DOWN DOOR

Size: W 530mm, D 410mm, H 310mm. Build in W 504 x D 460 X H 283mm

**SOV30T** OF300FT 30 litre oven + thermostat without grill

**SOV30GT** OF311FGT 30 litre oven + thermostat with grill built in

**SOV30GTLI** OF311FGT 30 litre oven + thermostat with grill built in +12v interior lamp and 12 v ignition to oven and grill burners.

### 20 LITRE OVEN WITH HINGE DOWN DOOR

New for 2004 a new small oven developed due to the numerous requests for this size. The oven will make retrofitting an oven to Continental motorhomes much easier.

Size: W 530mm, D 415mm, H 430mm. Build in W 500 x D 460 X H 410mm

**SOV20T** OF200FT 20 litre oven + thermostat without grill

**SOV20GT** OF211FGT 20 litre oven + thermostat with grill built in

**SOV20GTLI** OF211FGT 20 litre oven + thermostat with grill built in + 12v Interior lamp and 12 v ignition to oven and grill burners.

### SMEV MARINE COOKERS - OFFSHORE RANGE

If you intend to cook off shore in rough weather you need the prestige range of 100% Marine Grade Stainless Steel Cookers from SMEV. The 4 Burner all stainless version with Hob, Oven with integral Grill. Is fully gimbaled. The SMEV 4 burner cooker is excellent for any galley, it features 12v Electronic Ignition, Thermostatic Oven Control, Interior Lamp, Over Door Lock, view through mirror Glass Fronted hinge down Door, Fitted with Pan Holders, and Fiddle Rail, all burners fitted with flame failure cut off (as all SMEV appliances are) & finished in brushed stainless steel for easier cleaning. Side heat shields are included with cooker. Dimensions: Gimbaled 524W x 500D x 505H approx.

**SOVM311GTLI** Full marine spec cooker 4 burner Gimbaled

### 400 SERIES SMEV INTEGRATED MODULAR COOKER

Latest design matt finish stainless steel units. Very high quality modern design from Smev. The modular concept allows many new design variations of your kitchen installation. The S402 hob with integrated grill cabinet is a significant new design feature. Standard version Grey glass BLK=Black glass.



**555 GRILL**



**0311 FGT  
4 BURNER COOKER**



**OF300FT/OF311 FGT**

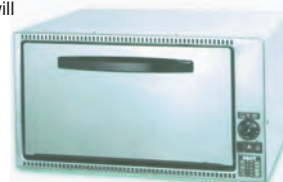

**OF200FT/OF211 FGT**



**SOVM311GTLI**



**S402** 4 burner hob, crystal glass hob cover & grill cabinet.

**S402** Size: width 484mm, depth 514mm, height 244mm

**BLK**

**S403** 4 burner hob, crystal glass hob cover without grill. Size: width 484mm, depth 514mm, height 125mm. **ORDER ONLY**



**S404** 4 burner hob, crystal glass hob cover & thermostatic hinge down door oven.

**S404** Size: width 484mm, depth 514mm, height 499mm.

**BLK**

**S414** 4 burner hob, crystal glass hob cover & thermostatic hinge down door oven with integral grill. Size: width 484mm, depth 514mm, height 499mm.



**S401** 4 burner hob, crystal glass hob cover, grill cabinet & thermostatic hinge down door oven.

**BLK** Size: width 484mm, depth 514mm, height 575mm



**S400** 4 burner hob, crystal glass hob cover, grill cabinet, thermostatic hinge down door oven and left hand hinged pan storage cabinet. Size: width 484mm, depth 514mm, height 914mm.

**IMPORTANT NOTE: ALL GAS APPLIANCES MUST BE INSTALLED BY A QUALIFIED GAS ENGINEER. IF APPLIANCE IS DIY INSTALLED THE GAS INSTALLATION MUST BE INSPECTED FOR SAFETY BY A COMPETENT PERSON BEFORE USE.**

**WE NOW OFFER INSTALLATION, GAS SAFETY TEST AND REPAIR SERVICE BY [SupremeTech.co.uk](http://SupremeTech.co.uk)**



**0844 414 2324**



**0844 414 2425**



Buy securely online at [Leisurelines.net](http://Leisurelines.net)

## GAS CERAMIC COOKTOP: ELEGANT, EASY TO CLEAN, ENERGY-EFFICIENT

The future of cooking available now: Dometic DCC11, an energy-saving cooktop, well thought-out down to the last detail. Each of the two hotplates has a simmering plate behind it, which is heated by the flue gas from the burner in front. This means you can cook in two pans when operating one burner. What's more, the new ceramic cooktop stands out with its stunning looks and effortless cleaning. Available in black or white.

Voltage 12 volts DC (electronic ignition) 2-burner gas ceramic cooktop with 4 cooking areas (2 boiling plates + 2 simmering plates). Output 1 x 1.6 kW; 1 x 1.3 kW, Gas consumption 210 g/h, Gas supply pressure 30 mbar, Easy-to-clean, frameless design with bevelled glass, Hot surface indicator for maximum safety, Easy installation No chimney required. Weight: 11 kg. Approx Dimensions (W x H x D): 566 x 110 x 445 mm, Built-in dimensions (W x H x D): 546 x 110 x 428 mm. Available Black **DCC11K** White **DCC11W**

### NEW DCC11

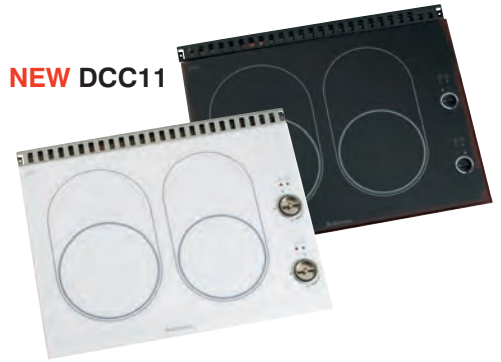

## WBX100 WEBASTO X100 CERAN® DIESEL COOKTOP

The Webasto Diesel Cooker X100 will be of particular interest for those who intend to have only one fuel on board. Individualists will appreciate the usage of Diesel to cook during trips in the great outdoors. The combustion of the diesel fuel creates heat which is conducted to a CERAN® cooking plate. The ceramic cooktop can be used with one cooking stove top and one for keeping meals warm (or warming up).

- 1,9 kW cooking power
- Using diesel out of vehicles fuel tank
- Very elegant look due to CERAN® cooktop
- Easy to clean
- Altitude switch for usage in heights above 1500 m
- Warning light indicates hot CERAN® plate

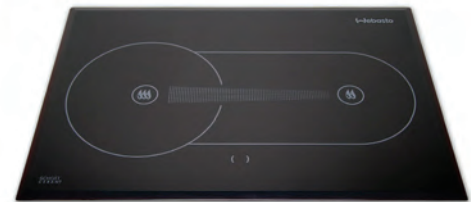

**WEBASTO WBX100 DIESEL COOKTOP**

## NEW HIGH SPEC MATCHING STAINLESS STEEL COOKER HOODS

Our new range of cooker hoods have been expressly designed to complement the SMEV range of cooking appliances. The hoods have been developed and manufactured to the highest standards of quality for a trouble free installation and a pleasing finished installation. Produced specially for the motorhome and inland waterways industry. The underside extraction zone incorporates an aluminium panel filter as you would find in a domestic hood (not Omega). Standard outlet 80mm hole in upper surface. All hoods require adaptor SCH60ADPT to connect to 60mm SCH60DUCT ducting to vent air outside to either roof flue SCH60RFL or sidewall vent SCH60VW.

**NEW** Swing 40cm Stainless Steel cooker hood 12 volt only with two built in 10w halogen down lighters. Fan flow rate of 200m<sup>3</sup>/h. Controls for fan and lighting is easy to hand on the front edge of the hood. Dimensions 400mm wide x 280mm deep X 50mm high.

**SCHSW40** SWING 40CM COOKER HOOD STAINLESS 12V 2 X HALOGEN SPOTLIGHTS

**NEW** Omega Basic 38cm Stainless Steel simple design cooker hood 12 volt only. Fan flow rate of 120m<sup>3</sup>/h. On/off switch to underside.

**SCHOMB** OMEGA BASIC 38CM COOKER HOOD STAINLESS 12V

**NEW** Omega Flat 38cm Stainless Steel simple design cooker hood 12 volt only. Fan flow rate of 120m<sup>3</sup>/h. 2 x On/off switch to underside for fan & two built in 10w halogen down lighters.

**SCHOMF** OMEGA FLAT 38CM STAINLESS COOKER HOOD 12V 2 X HALOGEN SPOTLIGHTS

**NEW** Block Filter Basic 40cm Grey finish Basic 40cm Grey finish flush fitting design cooker hood 12 volt only. Fan flow rate of 120m<sup>3</sup>/h. On/off switch & mesh filter panel to underside.

**SCHBFBG** BLOCK FILTER BASIC 40CM COOKER HOOD GREY 12V

## NEW RECIRCULATING FILTERING COOKER HOODS

The filtering hoods can be installed without external exhaust connection. An internal lever allows easy conversion of an externally exhausted hood into filtering mode. Fan flow rate of 230m<sup>3</sup>/h.

**NEW** Shade filtering Hood 40cm Stainless Steel cooker hood 12 volt only. Controls for fan and lighting on the front edge of the hood. 2 x Halogen spotlights.

**SCHFSH** SHADE FILTERING 40CM COOKER HOOD STAINLESS 12V 2 X HALOGEN SPOTLIGHTS

**NEW** Sigma filtering Hood 40cm Stainless Steel cooker hood 12 volt only. Push button controls for fan on the front edge of the hood.

**SCHFSG** SIGMA FILTERING 40CM COOKER HOOD STAINLESS 12V

**NEW** Vanta LED filtering Hood 40cm Stainless Steel cooker hood 12 volt only. Push button controls for fan and integrated LED lighting on the front edge of the hood.

**SCHFVT** VANTA FILTERING BASIC 40CM COOKER HOOD STAINLESS 12V



**OMEGA BASIC**

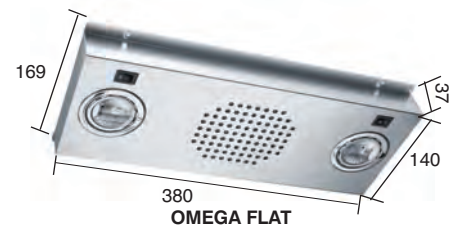

**OMEGA FLAT**

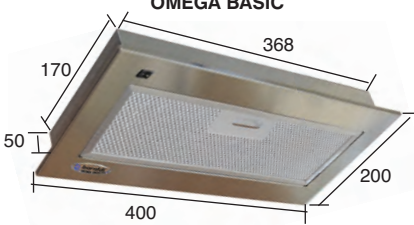

**BLOCK FILTER BASIC**

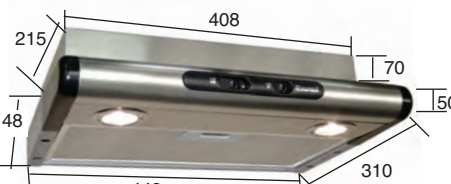

**SIGMA FILTERING**



**VANTA LED FILTERING**



### SCHSW40

for dimensions see drawing on page 43



**SHADE FILTERING**  
can also be ducted externally

**IMPORTANT NOTE: ALL GAS APPLIANCES MUST BE INSTALLED BY A QUALIFIED GAS ENGINEER. IF APPLIANCE IS DIY INSTALLED THE GAS INSTALLATION MUST BE INSPECTED FOR SAFETY BY A COMPETENT PERSON BEFORE USE. ALL SMEV PRODUCTS ARE FITTED WITH FFD FLAME FAILURE CUT OFF DEVICES AS STANDARD**

**WE NOW OFFER INSTALLATION, GAS SAFETY TEST AND REPAIR SERVICE BY [SupremeTech.co.uk](http://SupremeTech.co.uk)**



## CRAMER OVENS

Heat-resistant and panorama glass door, thermostat, electronic 12-volt ignition, grill, interior light, bottom-hinged door, enameled baking tray and pan, stainless steel rack.

- DCRCBCG** CRAMER 32 LITRE 1.2KW OVEN + 1.6KW GRILL Weight: 18.4 kg, Dimensions: W528 x H430 x D422 mm, Built-in dimensions: W462 x H484 x D422 mm
- DCRCMBOA** CRAMER 18 LIT 1.1Kw OVEN Weight: 13.7 kg, Dimensions: W410 x H311 x D490 mm, Built-in dimensions (W x H x D): 398 x 304 x 490 mm



**CBCG**



**CMBOA**

## CRAMER COMPACT HOBS WITH HINGED GLASS COVERS

Heat-resistant safety glass lid, detachable chrome pot grids, stainless steel burner caps, safety ignition system.

- DCRCE99ZF460IG** CRAMER 2 BURNER HOB + GLASS LID Output: 2 x 1.6 kW, Weight: 3.3 kg, Dimensions: W460 x H90 x D335 mm, Built-in dimensions: W440 x D315 mm.
- DCRCE99ZF460BLK** CRAMER 2 BURNER Enameled black surface HOB + GLASS LID, Output: 2 x 1.6 kW, Weight: 3.3 kg, Dimensions: W460 x H90 x D335 mm, Built-in dimensions: W440 x D315 mm
- DCRCE99DFIG** CRAMER 3 BURNER HOB + GLASS LID, Output: 3 x 1.6 Kw, Weight: 5.1 kg, Dimensions: W520 x H90 x D445 mm, Built-in dimensions: W510 x D435 mm



**DCRCE99ZF460IG**



**DCRCE99ZF460BLK**



**DCRCE99DFIG**



**DCRCE88ZFEK2000N**

## CRAMER COMPACT HOBS

Detachable chrome pot grids, stainless steel burner caps, safety ignition system.

- DCRCE88ZFEK2000N** CRAMER 2 BURNER HOB - S/STEEL Output: 2 x 1.6 kW, Weight: 1.6 kg, Dimensions (W x H x D): 450 x 50 x 325 mm, Built-in dimensions (W x D): 430 x 305 mm
- DCRCE94DFEK2000N** CRAMER 3 BURNER HOB - S/STEEL, Output: 3 x 1.6 Kw, Weight: 4.1 kg, Dimensions: W500 x H50 x D400 mm, Built-in dimensions: W470 x D370 mm.
- DCRCE88VFEK2000I** CRAMER 4 BURNER HOB - S/STEEL, Output: 4 x 1.6 Kw, Weight: 4.1 kg, Dimensions: W400 x H50 x D500 mm, Built-in dimensions: W370 x D470 mm.



**DCRCE94DFEK2000N**



**DCRCE88VFEK2000I**

## CRAMER COMBINATION UNITS WITH GLASS LIDS

Heat-resistant safety glass lid, detachable chrome pot grids, stainless steel burner caps, tap fitting inside, safety ignition system, siphon waste, rubber seal, with hole for tap (dia 27 mm).

- DCRCE00MINIBOH12** CRAMER 2 BRNR HOB/SINK COMBO +G/LID, Output: 2 x 1.6 kW, Weight: 5 kg, Dimensions: W600 x H146 x D445 mm, Built-in dimensions: W590 x D435 mm.
- DCRKOMBIDFHI2112** CRAMER 3 BRNR HOB/SINK COMBO +G/LIDS, Output: 3 x 1.6 Kw, Weight: 6.1 kg, Dimensions: W840 x H147 x D436 mm



**DCRCE00MINIBOH12**



**DCRKOMBIDFHI2112**

## CRAMER COMBINATION UNITS

Detachable chrome pot grids, stainless steel burner caps, tap fitting outside, safety ignition system, siphon waste, and rubber seal.

- DCRCMEK2000I** CRAMER 2 BRNR HOB + SINK - S/STEEL, Output: 2 x 1.6 Kw, Weight: 4.2 kg, Dimensions: W460 x H124 x D480 mm, Built-in dimensions: W440 x D460 mm



**DCRCMEK2000I**



**DCRCE99B410LIG**

## CRAMER SINK UNITS WITH GLASS LIDS

Heat-resistant safety glass lid, siphon waste, rubber seal.

- DCRCE99B410LIG** CRAMER SQUARE SINK + GLASS LID, Weight: 3.3 kg, Dimensions: W410 x H125 x D335 mm, Built-in dimensions: W400 x D325 mm.
- DCRCE99BHI27IG** CRAMER SQUARE SINK + GLASS LID, integrated waste tray, with hole for tap (dia 27 mm), Weight: 4.1 kg, Dimensions: W420 x H151 x D445 mm, Built-in dimensions: W390 x D435 mm.
- DCRCE99BTK600HI2** CRAMER SINK + LH DRAINER + GL/LID, integrated waste tray, with hole for tap (dia 27 mm), Weight: 5.1 kg, Dimensions: W600 x H136 x D445 mm, Built-in dimensions: W590 x D435 mm.

## CRAMER SINK UNITS With siphon waste, rubber seal.

- DCRCE02B325I** CRAMER ROUND SINK - S/STEEL, Weight: 1.2 kg, Dimensions: dia325 x H126 mm, Installation dimension: D298 mm.
- DCRCE88BI** CRAMER RECTANGULAR SINK, Weight: 1.7 kg, Dimensions: W400 x H124 x D325 mm, Built-in dimensions: W370 x D295 mm
- DCRCE88BTK550** CRAMER RECTANGULAR SINK + DRAINER 550, Weight: 2.6 kg, Dimensions: W550 x H134 x D400 mm, Built-in dimensions: W530 x D380 mm.
- DCRCE88BTK650** CRAMER RECTANGULAR SINK + DRAINER 650, Dimensions: W650 x H134 x D400 mm



**DCRCE99BHI27IG**



**DCRCE99BTK600HI2**



**DCRCE02B325I**



**DCRCE88BI**

## CRAMER PORTABLE HOB & GRILL

- DCRCE88ZF** CRAMER 2 BRNR PORTABLE SS HOB + GRILL, Burner output: 2 x 1.6 kW, Grill output: 1.3 kW, Safety ignition system, Weight: 6.0 kg, Dimensions (W x H x D): 450 x 191 x 325 mm.



**DCRCE88BTK550**



**DCRCE88ZF**

**IMPORTANT NOTE: ALL GAS APPLIANCES MUST BE INSTALLED BY A QUALIFIED GAS ENGINEER. IF APPLIANCE IS DIY INSTALLED THE GAS INSTALLATION MUST BE INSPECTED FOR SAFETY BY A COMPETENT PERSON BEFORE USE. ALL SMEV PRODUCTS ARE FITTED WITH FFD FLAME FAILURE CUT OFF DEVICES AS STANDARD**

WE NOW OFFER INSTALLATION, GAS SAFETY TEST AND REPAIR SERVICE BY [SupremeTech.co.uk](http://SupremeTech.co.uk)



0844 414 2324



0844 414 2425



Buy securely online at [Leisurelines.net](http://Leisurelines.net) Kitchen - Cramer

### INTEGRATED WORKTOP WASTE BIN

New integrated waste bin matches style of Smev 8000 range. Matt stainless frame with built in flush fitting integral hinged glass cover. Waste bucket has a capacity of 2 litres and is easily removed for emptying with its folding handle.

Size 182 mm deep, 192 mm length, 210 mm width.  
**STWB** Integrated worktop waste bin

### FLEXIBLE SINK BASE PROTECTOR

Flexible vinyl sink base protection mat protects base of sink from the knocks and bumps and Scratches in day to day usage. Ideal for enamel sinks. Almond colour, size 255mm x 300mm. Can be cut to size.

**SBPM** Flexible Sink base protection mat



**SBPM**



**STWB**

### SMEV GLASS COVERS

One piece glass covers for sinks and hobs, Brown is our standard stock colour. Grey and Mirror colours, if not in stock, are available manufactured to order. Always check stock availability for alternate colours.

Code	Model	Colour	Fits following SMEV hob or sink
<b>SHC263B</b>	263	Brown	Series.2000 - 930 - 938 - 963 - 971
<b>SHC264B</b>	264	Brown	909 - 910 - 931 - 932 - 937 - 950 951 - 955 - 965 - 966 - 970 - Series.1000
<b>SHC267B</b>	267	Brown	913 - 958
<b>SHC267G</b>	267	Grey	913 - 958
<b>SHC270G</b>	270	Grey	Series.4000 & Series.6000
<b>SHC271M</b>	271	Mirror	COOKERS 0300F - 0311FG
Half folding glass covers			
<b>SHC770G</b>	770	Grey	Series.4000 & Series.6000

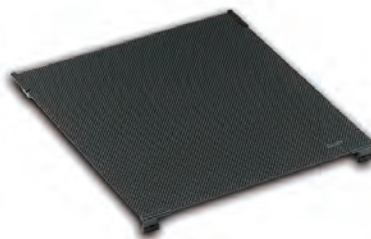

**SERIES 200**



**SERIES 700**

### INTEGRATED HOB AND SINK UNITS

- CGH1345** 1 BRN ROUND HOB & GLASS LID  
Integrated single burner round hob with black glass lid 340mm diameter 80mm height. 1 semi rapid burner. 2.13kg
- CGH1348** 2 BRN OVAL HOB & GLASS LID  
Integrated twin burner oval hob with black glass lid 510 x 390mm oval 80mm height. 1 standard & 1 semi rapid burner. 3.9kg
- CGS1750** Integrated round sink unit with hinged black glass cover and single folding cold tap 380 diameter x 180 deep. 5 kg  
**CGS1751** CGS1750 with single folding cold tap
- CGS1450** Integrated oval sink unit with hinged black glass cover and single folding cold tap 510 x 390mm oval x 161 deep. 7.0 kg
- CGS1451** CGS1450 with mixer tap.



**CGH1345**



**CGH1348**



**CGS1750**



**CGH1348**



**CGH1348**



**CGS1450 CGS1451**

### MARINE PAN HOLDERS

- CGA1370** COLUMN KIT 1 PAN HOLDER FOR 1350
- CGA1371** COLUMN KIT 2 PAN HOLDER FOR 1351 & 1360
- CGA1372** COLUMN KIT 3 PAN HOLDER FOR 1352 & 1362

### COMPACT FOLDING HOB AND SINK COMBINATION

Great little design Hob folds into sink to save space when not in use.

- CLC1701** 300mm dia round bowl with single burner hob fixed to folding glass cover. Folding tap and 1 x semi-rapid burner.
- CLC1710** 320 x 350mm rectangular bowl with single burner hob fixed to folding glass cover. Folding tap and 1 x semi-rapid burner.



**CGH1336**



**CGH1347**



**CGA1370**

### STAINLESS STEEL INSET HOBS WITH FOLDING GLASS LIDS

- CGH1336** 2 BURNER STAINLESS INSET HOB WITH HINGED BLACK GLASS LID  
530 X 325 X 80mm high
- CGH1347** 3 BURNER STAINLESS INSET HOB WITH HINGED BLACK GLASS LID  
450MM X 450MM X 85mm high.



**CLC1701**



**CLC1710**

**IMPORTANT NOTE: ALL GAS APPLIANCES MUST BE INSTALLED BY A QUALIFIED GAS ENGINEER. IF APPLIANCE IS DIY INSTALLED THE GAS INSTALLATION MUST BE INSPECTED FOR SAFETY BY A COMPETENT PERSON BEFORE USE. ALL GAS PRODUCTS ARE FITTED WITH FFD FLAME FAILURE CUT OFF DEVICES AS STANDARD**

WE NOW OFFER INSTALLATION, GAS SAFETY TEST AND REPAIR SERVICE BY [SupremeTech.co.uk](http://SupremeTech.co.uk)



New high quality cooker tops made with tempered anti-scratch crystal glass for crisp modern styling. Surface mounted gas hobs and sink combo units complete with stainless steel inset sink. For marine use all the hobs and combo units come with integrated socket for column pan holders. Marine pan holders available as an accessory.  
 BURNER OUTPUTS: STANDARD 1000W – 73g/h; SEMI-RAPID 1900W – 127g/h; RAPID 3000W -218g/h.

### FLUSH MOUNTING GLASS HOBS

- CGH1320** Crystal glass 1 burner hob unit with 1 semi-rapid burner. Size 320 x 285mm x height 47mm above 100mm below 5 kg
- CGH1350** Crystal glass 1 burner hob unit with 1 semi-rapid burner. Size 365 x 200mm x height 47mm above 100mm below 5 kg
- CGH1351** Crystal glass 2 burner hob unit with 1 standard and 1 semi-rapid burner. Size 380 x 280mm x height 47mm above 100mm below 7 kg
- CGH1352** Crystal glass 3 burner hob unit with 1 standard, 1 semi-rapid & 1 rapid burner. Size 400 x 300mm x height 47mm above 100mm below 10 kg
- CGH1355** Crystal glass 3 burner hob unit with 1 standard, 1 semi-rapid & 1 rapid burner. Size 505 x 410mm x height 47mm above 100mm below 10 kg
- CGH1357** Crystal glass 2 burner hob unit with 1 semi-rapid and 1 rapid burner. Size 500 x 300mm x height 47mm above 100mm below 8 kg

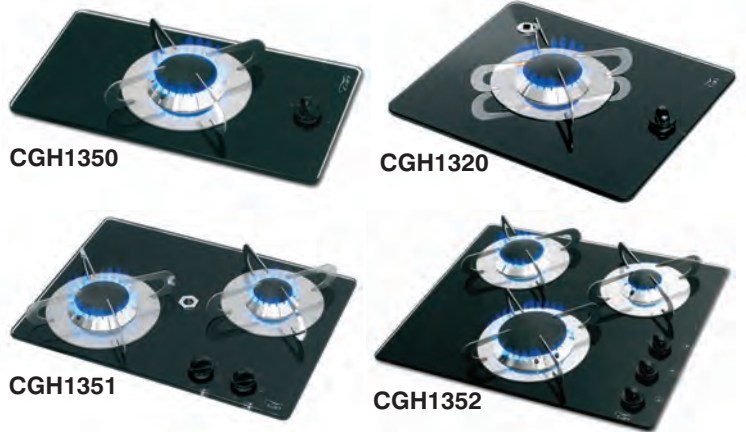

### FLUSH MOUNTING COMBO UNITS

- CGC1360** Crystal glass Combination Unit 2 burner gas hob (600 x 420 x height 47mm above 180mm below) complete with polished stainless steel sink 300mm dia x 180mm deep. 2 Semi rapid burners 15KG
- CGC1361** Crystal Glass Combination Unit 3 burner gas hob (800 x 420 x height 47mm above 180mm below) complete with polished stainless steel sink 300mm dia x 180mm deep. 1 Standard, 1 Semi Rapid & 1 Rapid burner. 18KG
- CGC1362** Crystal Glass Combination Unit 2 burner gas hob (540 x 390 x height 47mm above 140mm below) complete with elliptical stainless steel sink 356x240mm x 130mm deep. With 34mm hole for single lever mixer tap. 1 Standard & 1 Semi Rapid burner
- CGC1364** Crystal Glass Combination Unit 2 burner gas hob (785 x 315/355 x height 47mm above 120mm below) complete with stainless steel sink 260m dia x 120mm deep. With 27mm hole for single lever mixer tap. 1 Standard, 1 Semi Rapid burner.
- CGH1353** 3 BURNER TRIANGULAR HOB 1 standard & 2 Semi Rapid burners. Size width 500 x Depth 410 x Height 47+ 90.
- CGC1366** New stylish glass surface cooktop made with tempered anti scratch glass with inset stainless steel sink. TAP NOT INCLUDED. (800 x 365 x height 47mm above 150mm below) Burners- 1 x Standard: 1000 W - 73 g/h & 1 x SEMI-RAPID: 1750 W - 127 g/h
- CGC1323** Inset single burner round bowl combination unit with glass lid 1 Semi Rapid burner. Size width 530 x Depth 325 x Height 50+ 120. TAP NOT INCLUDED
- CGC1316** Inset 2 burner round bowl combination unit with glass lid. 1 standard & 1 Semi Rapid burners Size width 720 x Depth 338 x Height 50+ 120. TAP NOT INCLUDED
- CGC1400** Inset 2 burner square bowl combination unit with glass lid . 1 standard & 1 Semi Rapid burners Size width 720 x Depth 338 x Height 50+ 120. TAP NOT INCLUDED

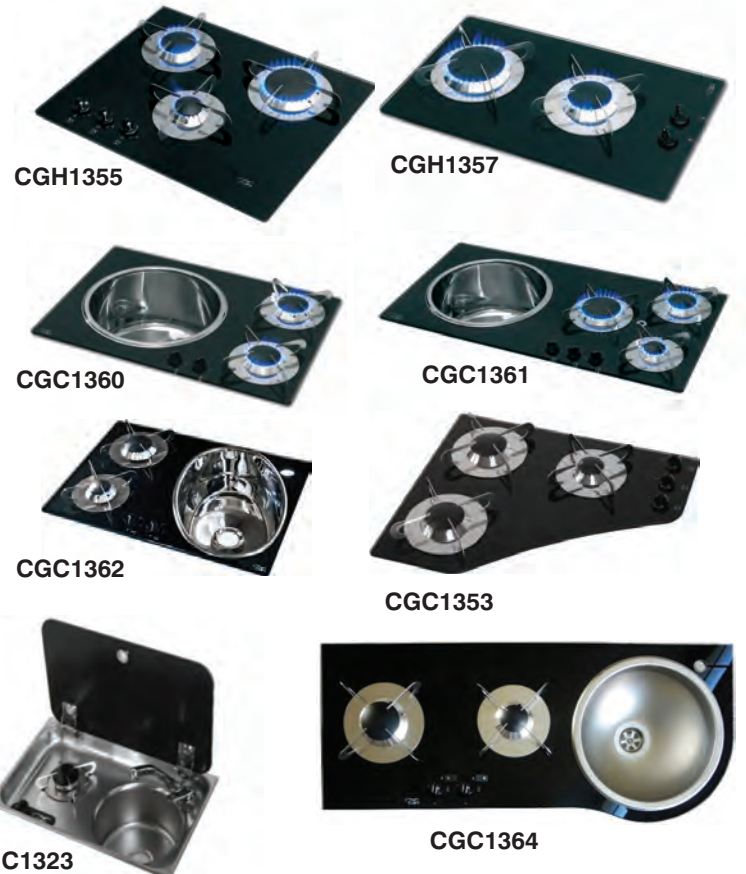

**IMPORTANT NOTE: ALL GAS APPLIANCES MUST BE INSTALLED BY A QUALIFIED GAS ENGINEER. IF APPLIANCE IS DIY INSTALLED THE GAS INSTALLATION MUST BE INSPECTED FOR SAFETY BY A COMPETENT PERSON BEFORE USE.**

**ALL GAS PRODUCTS ARE FITTED WITH FFD FLAME FAILURE CUT OFF DEVICES AS STANDARD**

**WE NOW OFFER INSTALLATION, GAS SAFETY TEST AND REPAIR SERVICE BY [SupremeTech.co.uk](http://SupremeTech.co.uk)**



# WAECO CoolMatic DC COMPRESSOR FRIDGE



## CR Premium refrigerators

Marine & Camper Tropical-rated compressor refrigerators with luxury equipment: separate \*\*\* freezer compartment, double door lock, Cool Blue interior light and a lot more. Excellent, functional design in stainless steel look.



CoolMatic CR-65 CoolMatic CR-110 CoolMatic CR-50 CoolMatic CR-80 CoolMatic CR-140



1 double door lock, top and bottom  
2 separately insulated \*\*\* freezer compartment  
3 functional surfaces and trays  
4 interior light  
5 recessed door grips  
6 bottle holder

## WAECO CR & CRP FEATURES

Insulation - CFC-free polyurethane foam

System - Fully hermetic Danfoss BD35F compressor with integrated control electronics, low-voltage protection, electronic fuse / automatic reverse pole protection, dynamically ventilated wire tube condenser, mechanical, continuously variable thermostat

Material - Stainless steel fittings, plastic interior, plastic door frame, body with coated metal frame

Colour Body: black, door frame: silver, door panel: matt-silver (brushed stainless steel appearance)

Quality features - Interior light, door with magnetic seal, variable door mounts and locks right / left, door with double lock (top / bottom) and dual function (locking / ventilation), separately insulated \*\*\* freezer compartment, additional, foamed rear-wall evaporator in the interior, easy-to-change decor panel, 4 installation points for fastening from inside without installation frame, right-hinged door as Standard. (Easily hand able when installing), standard or flush-mount installation frame available as accessory, condensation drainage via hose connection or collection tank (except CRP-40), ideal in confined spaces: The cooling unit can be fitted separately (CRP-40 ONLY)

## Compact entry-level model

39-litre capacity and cool CR looks: the CRP-40 built-in refrigerator is ideal for smaller recreational vehicles and for confined spaces.



CoolMatic CRP-40

Model	CRP-40	CR-50	CR-65	CR-80	CR-110	CR-140
Stock OrderCode	RCRP40	RCR50	RCR65	RCR80	RCR110	RCR140
Gross capacity approx	39 litres including 5.3-litre freezer compartment	48 litres including 5-litre freezer compartment	64 litres including 7.2-litre freezer compartment	80 litres including 7.9-litre freezer compartment	108 litres including 10.2-litre freezer compartment	136 litres including 11.5-litre freezer compartment
Voltage	12 / 24 volts DC	12 / 24 volts DC	12 / 24 volts DC	12 / 24 volts DC	12 / 24 volts DC	12 / 24 volts DC and 100 – 240 volts AC
Average power consumption	approx. 40 watts	approx. 40 watts	approx. 45 watts	approx. 48 watts	approx. 50 watts	approx. 65 watts
Current consumption	(2)	1.4 Ah/h at +25°C	1.6 Ah/h at +25°C	1.8 Ah/h at +25°C	2.2 Ah/h at +25°C	2.3 Ah/h at +25°C
Ambient Temp (1)	(2)	1.7 Ah/h at +32°C	1.9 Ah/h at +32°C	2.1 Ah/h at +32°C	2.5 Ah/h at +32°C t	2.6 Ah/h at +32°C
Net Weight	18 Kg	19 kg	20 Kg	23 kg	28 kg	32 kg
Build in dimensions	with /without cooling unit:					
W x H x D (without Door) (3)	380 x 534 x 492 / 380 x 534 x 310	380 x 534 x 447 mm	448 x 525 x 492 mm	475 x 640 x 475 mm	520 x 745 x 505 mm	525 x 805 x 619 mm
Std install frame	RCRP40-EST	RCR50-EST	RCR65-EST	RCR80-EST	RCR110-EST	RCR140-EST
Flush install frame	RCRP40-EFM	RCR50-EFM	RCR65-EFM	RCR80-EFM	RCR110-EFM	RCR140-EFM

(1) Current consumption both at +5°C interior temperature and -18°C in the freezer compartment

(2) RCRP40 Average running time 23% at +20°C ambient temperature, 35% at +32°C ambient temperature, both at +5°C interior temperature

(3) Door adds 53mm projection on to depth measurement

## COOLMATIC MDC RANGE Compressor fridges with absorption dimensions

The same dimensions as commonly used absorption refrigerators – but considerably more useful capacity and cooling performance. MDC refrigerators need no gas supply, and no external ventilation either. 12/24 volts DC operation. Ventilation Panel standard or accessory, Right hinged door as standard, Depth dimension includes door, Average power consumption 45 watts, Interior light, door with magnetic seal, variable door hinges and locks (right / left), door with double lock (top / bottom) and dual function (locking / ventilation)

- RMDC50** 43 Litre Fridge inc 4 Ltr Freezer, 15Kg, Sizes 425W x 565-620H x 445D
- RMDC65** 64 Litre Fridge inc 10 Ltr Freezer, 20Kg, Sizes 485W x 618-673H x 475D
- RMDC90** 90 Litre Fridge inc 10 Ltr Freezer, 28Kg, Inc Vent Panel, Sizes 485W x 830H x 475D
- RMDC110** 110 Litre Fridge inc 13 Ltr Freezer, 30.5Kg, Inc Vent Panel, Sizes 525W x 806H x 547D

**RMDC50VP** Vent Panel for RMDC50 (8000G-003)

**RMDC65VP** Vent Panel for RMDC65 (8000G-002)

CoolMatic



CoolMatic MDC-50 CoolMatic MDC-65 CoolMatic MDC-110 CoolMatic MDC-90

**IMPORTANT NOTE: ALL GAS APPLIANCES MUST BE INSTALLED BY A QUALIFIED GAS ENGINEER. IF APPLIANCE IS DIY INSTALLED THE GAS INSTALLATION MUST BE INSPECTED FOR SAFETY BY A COMPETENT PERSON BEFORE USE. Contents, specifications and availability are subject to change serving the technical improvement.**

WE NOW OFFER INSTALLATION SERVICE IN KENILWORTH BY [SupremeTech.co.uk](http://SupremeTech.co.uk)

## Silent Cooling for Awning & Holiday Home.

The Dometic CombiCool RF 60 3-way absorption refrigerator provides all the convenience you're accustomed to at home. A glimpse inside reveals: door trays, adjustable shelves. The Dometic CombiCool RF 60 utilises three different types of power source (12 volts, 230 volts, gas) to provide high-performance cooling. It has become a highly popular among campers who afford pride of place under the awning. Gross capacity: approx. 60 litres. Cooling capacity: up to 30°. Size: 486W x 670H x 490D.

**RRF60** FREESTANDING 60 L 3 WAY FRIDGE

## SLEEK PORTABLE ABSORPTION COOLER

A dazzling performance by the first absorption cooler with elegant aluminium housing! The cooler looks unbelievably good and is well-connected everywhere – at a barbecue on the patio, at a picnic under the awning or far away from civilisation.

Thanks to optimised absorption technology it provides excellent cooling performances up to 33°C below ambient temperature and is completely silent. The CombiCool RC2200EGP has a capacity of 41 litres and a perfect interior design which allows you to cool up to eight 2-litre bottles. It features recessed side grips to make the unit comfortable to transport.

Absorption cooler for 12 volts, 230 volts and gas operation. Absolutely silent operation, 3-stage flame regulation in gas mode, piezo ignition, thermostat regulation in 230-volt mode. Vertical space for 1.5- and 2-litre bottles. Ice cube tray included

Size: 500W x 444H x 508 D

**RC2200EGP** Dometic CombiCool 2200

## WAECO CoolFun MB 40 Jukebox hero

Thermoelectric cooler with integrated sound System with connection for Mp3 player. Gross capacity: approx. 40 litres, W x H x D: 580 x 440 x 390 mm, Voltage: 12 volts DC and 230 volts AC (220 – 240 V), Cooling up to 22°C below ambient temperature

**RCFMB40** Waeco CoolFun MB40

## COMPACT ABSORPTION COOLER

The Dometic CombiCool RC1200EGP absorption cooler runs on 12-volt supply in the vehicle, on 230-volt mains supply at home or at the campsite and can easily be switched to gas operation at remote locations. Capacity 41Litres, Cooling capacity up to 25oC below the ambient temperature. Weight 16kg. Colour Silver Grey. Size 500W x 508D x 441mm H.

**RC1200EGP** Dometic CombiCool 1200

## Dometic CB36 & CB40 Top Loading Fridge

Specially designed for confined spaces, Detachable cooling unit with 1.5-m supply cable, Vertical space for 2-litre bottles. In confined spaces, the cooling unit can be fitted to the side of the cooler (left / right), or up to 1.5 metres away. Top lids ready for you to attach work surface material for perfect integration. Cooling from normal refrigeration to \*\* deep freezing.

**RCB-36** 12/24 volts DC, Gross Capacity 36 litres  
Dimensions excluding compressor 400H x 410W x 410D

**RCB-40** 12/24 volts DC, Gross Capacity 40 litres  
Dimensions excluding compressor 455H x 500W x 340D

## RCD-30 & RCD-30W BUILT IN DRAWER FRIDGE

Convenient access fridge with easy pull drawers running on ball bearing slides, temperature regulation with continuously variable thermostat, unlocking and opening in a single movement, safe locking mechanism.

Temperature range +12oC to -2oC, Detachable cooling unit can be fitted to either side or up to 1.5-m away, Low voltage protection for battery, Capacity 30 litres. Build in size: W 440 x H 250 x D 730mm (560mm D without compressor), Weight 18kg.

**RCD-30** BUILT IN DRAWER FRIDGE BLACK

**RCD-30W** BUILT IN DRAWER FRIDGE BLACK WITH WHITE DRAWER FRONT.



RRF60



RC2200EGP



RCFMB40



RC1200EGP



RCD-36

RCB-40

## Draw Fridge Fit's in where other fridges can't

Even low-headroom storage space can be used for high-performance compressor cooling - the WAECO CoolMatic CD built-in drawer fridges make it possible. They are also suitable for outside storage compartments. And great as a flybridge fridge!



RCD-30



RCD-30W



RCRD50

## NEW RCRD50 DRAWER FRIDGE

DRAWER VERSION OF THE POPULAR CR50 COMPRESSOR FRIDGE. ALSO HAS THE FEATURE OF A REMOVEABLE FREEZER COMPARTMENT.

**IMPORTANT NOTE: ALL GAS APPLIANCES MUST BE INSTALLED BY A QUALIFIED GAS ENGINEER. IF APPLIANCE IS DIY INSTALLED THE GAS INSTALLATION MUST BE INSPECTED FOR SAFETY BY A COMPETENT PERSON BEFORE USE.**  
Contents, specifications and availability are subject to change serving the technical improvement.

WE NOW OFFER INSTALLATION SERVICE IN KENILWORTH BY [SupremeTech.co.uk](http://SupremeTech.co.uk)



0844 414 2324



0844 414 2425

## COOLING FANS FOR ANY MAKE OF 3 WAY GAS FRIDGE.

Installing a fridge fan improves fridge cooling performance in hotter climates. Fitted to the rear of the upper fridge vent, the fan draws out hot air from behind fridge to improve air circulation and improve cooling efficiency of fridge. Complete with 3-position switch for manual, automatic & off functions. When in automatic mode, the built in air temperature sensor switches on the fan automatically when the temperature behind the fridge reaches 30 > 35°C. This temperature can easily be reached even in the British summer on fridges installed correctly with upper and lower fridge vents. When holidaying in southern Europe this will be a daily situation. In hot weather if you feel the fridge isn't as cold as usual its probably overheating, check the upper vent temperature. You need a fridge fan. A fridge fan will improve the cooling performance of any make of 3 way gas absorption fridge. The fan pulls hot air out of the top vent allowing more cooler air to enter the lower vent. The improved airflow reduces the overheating of absorption unit allowing a more efficient process of cooling fridge interior. Fridge fans are not suitable for DC compressor based fridges and freezers.

**FFT1** is suitable for UK and short visits to southern Europe with 80 ltr or smaller fridges.  
**FFT2** is for longer stays in southern Europe and for much larger fridges and freezers in the UK.

Technical data.	FFT1	FFT2
Number of fans	1	2
Current draw		
Manual Amp/Hr	0.25	0.40
Auto Amp/Hr	0.35	0.65
Fan airflow		
Manual m3/Hr	110	220
Auto m3/Hr	180	360
Voltage DC	12	12
Length mm	120	275
Height mm	120	120
Depth mm	25	25

**FFT1** Single thermostatic 12v fridge cooling fan  
**FFT2** Twin thermostatic 12v fridge cooling fan

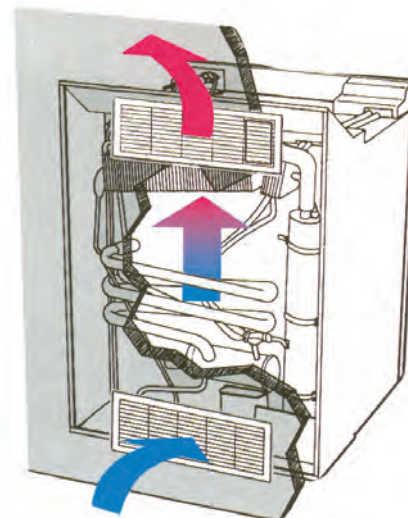

Correct installation of the grilles ensures the refrigerator's optimum performance. (Shown example: L100/L200)

## DOMETIC INTEGRATED FRIDGE VENTS & WINTER COVERS.

Industry standard design integrated fridge vents and winter covers designed for any 3 way gas fridge installation. Centre section of vent is easily removed making installation and eventual inspection, cleaning & servicing the rear of fridge much easier. The vents provide the correct level of ventilation airflow to maintain fridge efficiency. Upper vent has special position to locate the exhaust flue tube. A single or double fridge fan is easily installed to improve ventilation and therefore fridge performance, in hotter climates.

**L100** or **L200** Hole cut out 451mm x 156 mm; overall size 479 mm x 185.2 mm. For use with fridges up to 97 Litres.

**RL300W** Overall size 518mm Wide x 278mm High.

- RL100L200C** L100 upper & L200 lower vent kit with winter covers. Colour: cream
- RL100L200W** L100 upper & L200 lower vent kit with winter covers. Colour: white
- RMWINTCOVC** Spare pair of winter covers for L100L200 vents Cream
- RMWINTCOVW** Spare pair of winter covers for L100L200 vents White
- RL300W** L300 Vent with winter cover (white)
- RL300WINTCOVW** L300 Winter cover for L300 (white)
- RLEWS300** Arctic winter cover L300

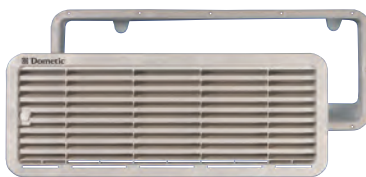

**L100 / L200** Vent Kit required for all 3 way fridges up to 97 litres

**New RL300W for fridges larger than 97 litres.**

MODEL CODE	RM122	RM123	RM5310	RM5330	RM5380	RMS8400/1	RMS8500/1	RM8400/1	RM8500/1/5	RML8551/5
Capacity, Litres <sup>A</sup>	31	31	60	70	80	85	96	95	106	189
Freezer, Litres			5	5	5	8	9	8	9	33
Net weight, kg	15	15	20	22	24	23	24.5	25	27.5	43
Max input, Watt										
- 230 Volt	N/A	75	125	125	125	125	125	125	135	190
-12 Volt	75	75	120	120	120	120	120	120	130	170
Gas, g/hour			18.3	18.3	18.3	18.3	18.3	18.3	18.3	22.5
Consumption										
- Electric, kWh/24h*	N/A	1.3	2.4	2.4	2.4	2.2	2.2	2.2	3.2	
- Gas, g/24 h*	140	140	270	270	270	270	270	270	270	380
Dimensions, mm (H x W x D)	585 x388 x440	585 x388 x440	618 x486 x474	821 x486 x474	821 x486 x474	821 x486 x569	821 x525 x569	821 x486 x569	821 x525 x569	1245 x525 x626
Interior light	no	no	LED	LED	LED	LED	LED	LED	LED	LED
Ignition	Piezo	Electronic	Battery electronic	Battery electronic	Battery electronic	Piezo/MES	Piezo/MES	Piezo/MES	Piezo/MES /AES	MES/AES
Base	FLAT	FLAT	FLAT	STEP	FLAT	STEP	STEP	FLAT	FLAT	FLAT

\* Approx consumption average ambient 25oC <sup>A</sup> - 8 Series Gross Volume with Freezer removed

8 series Last digit in code 0= Piezo Ignition, 1=Manual Energy Selection with Electronic Ignition, 5= AES Automatic Energy Selection

**WE NOW OFFER INSTALLATION & REPAIR SERVICE BY [SupremeTech.co.uk](http://SupremeTech.co.uk)**



This is just a selection we can supply any Dometic group product that is available. From brands such as Cramer, SMEV, Seitz, Waeco etc.



RM122- 2way Piezo  
RM123- 3way Electronic

## NEW DOMETIC 5 SERIES FRIDGES

The well-proven Dometic 4-series is replaced with the new 5-series featuring contemporary looks and an illuminated interior in ice-blue. plus, some technical improvements including a battery-powered ignition system and thermostat regulation in 230-volt and gas mode.

Dometic 5-series refrigerators have the same dimensions as their 4-series predecessors, so they can be replaced easily.

### 5 SERIES benefits

- Interior light
- User-friendly control panel
- Flexible shelf system
- Door with magnetic seal, reversible door hinges
- Battery-powered ignition unit
- Thermostat regulation in 230-volt and gas mode
- Flexible shelf positioning
- Door lock with vent option
- Integrated gas galvanometer

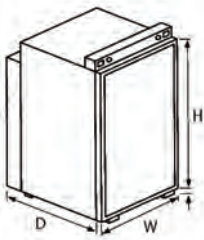

NEW RM5310  
Replaces  
RM4210 + RM4211LM + RM4213



NEW RM5330 STEP FRIDGE  
Replaces  
RM4230L + RM4233\*



NEW RM5380  
Replaces RM4281LM



Step Fridges  
RMS8401 RMS8501



RM8401 RM8501



### 0 - Battery Piezo Ignition

With battery ignition the gas is ignited at the push of a button. As soon as the flame goes out, the gas supply stops automatically. Thermostatic control on mains electric and gas operation.



**RM8551** The Dometic giant has an enormous 33 litre freezer. If this is removed you then have a huge 190 litre fridge.

## NEW Dometic 8-Series

Experience the most comfortable, best looking and most efficient absorption refrigerators in the world! The 8-series by Dometic sets the standard for all fridges of the future. New control panel with integrated LED-display and electronic Operation Control System, which employs visual alarm signals.

- ✓ LED operating functions display & energy saving LED interior light
- ✓ Removable freezer, flexible and functional shelf-system, door shelves with spill protection and a keep fresh vegetable bin allow optimum use of capacity.
- ✓ Innovative locking system with fingertip-opening
- ✓ Up to 20% less energy consumption
- ✓ Less weight by up to 10%
- ✓ Optional Automatic Drive Lock Device Locks the fridge door automatically as soon as the vehicle engine is started.



### 1- MES

The MES-system (Manual Energy Selector) also features electronic re-ignition which registers a dying flame and automatically reignites it. Simply turn the controls to select the energy source. Thermostatic control on all energy sources.



### 5 - AES

The AES-system (Automatic Energy Selector) selects the most efficient energy source automatically and guarantees efficient cooling performance at all times. It features automatic re-ignition. Manual energy selection is possible, too. Thermostatic control on all energy sources.

**IMPORTANT NOTE 8-Series** fridges have to be ordered Handed Left or Right hinged. This is **not** changeable after production.

**8-series** Last digit in code 0= Piezo Ignition, 1=MES, 5= AES. All variations available to order.

We can supply any Dometic group product that is available. From brands such as Cramer, Seitz, Waeco etc.

**IMPORTANT NOTE: ALL GAS APPLIANCES MUST BE INSTALLED BY A QUALIFIED GAS ENGINEER. IF APPLIANCE IS DIY INSTALLED THE GAS INSTALLATION MUST BE INSPECTED FOR SAFETY BY A COMPETENT PERSON BEFORE USE. Contents, specifications and availability are subject to change serving the technical improvement.**

WE NOW OFFER INSTALLATION, GAS SAFETY TEST AND REPAIR SERVICE BY [SupremeTech.co.uk](http://SupremeTech.co.uk)



0844 414 2324



0844 414 2425



TLFN80P



TLFN100E LCD



TLFN145A LCD



TLFN150A LCD



TLFN175A LCD



TLFN175AK LCD  
BLACK FRAMELESS



TLFRVENTW

TLFRCOVW



TLFRVLRGW



TLFRCOVLGW

### Quiet as a whisper

Absorption fridges work in a different way from the one at home. Because the Thetford fridges have no compressor, they are far quieter. So your enjoyment of your cosy caravan or motorhome won't be disturbed. Thetford absorption fridges are extensively tested, and come with a three year guarantee instead of the usual two years. In addition, the fridges have the CE mark of quality, they are also CFC-free and almost entirely recyclable. In short: Thetford absorption fridges are top quality!

### Manual, electric or automatic

All Thetford absorption fridges work on the mains (230V), direct current (12V) or gas, allowing you to use the fridge in all circumstances. Ignition and control mechanisms do, however, differ according to fridge model. Fridges with manual ignition can even work using only gas – without being connected to electricity. If you select gas for manual ignition you press the ignition button until the flame appears. The desired energy source is also selected manually for fridges with electric ignition. The flame will then be ignited electrically. Automatic fridges are provided with a Smart Energy Selection (SES) system. The SES system chooses the best available energy source. If it selects gas, the gas will be ignited automatically.

### Securely closed door

The fridge door's closing mechanism consists of a magnet around the door, a catch integrated into the door handle and, in some models, an extra catch on the underside for use when traveling. You can be sure that the fridge will remain securely closed when driving.

### Efficient door containers & Flexible bottle slide

The height of the storage container in the door can be adjusted, and they have a raised edge at the rear. In this way, any spillage will be contained and will not leak along the inner side of the door. In order to keep bottles in place in the door, Thetford fridges are equipped with a flexible bottle slide. Their pliability ensures that any size or shape of bottle can be held securely in place. Furthermore, the fridge door has a bottle rack to keep the larger bottles in place.

### Handy non-slip click strip

The height of the fridge's storage racks is adjustable. There is a plastic strip on the storage racks in the fridge. This strip ensures that provisions cannot shift while traveling.

### Flame indicator

Immediately following ignition, the flame indication on the control panel shows whether the flame is lit; stooping to look for the flame is a thing of the past.

### Defrost cycle and self-diagnosis

The LCD range is equipped with an automatic defrost cycle. This prevents ice collecting on the freezer element. This means that manual defrosting is unnecessary. Furthermore, these fridges have a reliable self-diagnosis system.

### Range Specifications

### NEW THETFORD FRIDGE RANGE

The fridges come boxed with installation seal and accessories. You will need to purchase correct Thetford fridge vents to suit fridge model. Thetford fridges come with right hand hinged doors as standard. It is possible to hand the doors afterwards.

- TLFN80P THETFORD N80P
- TLFN100E THETFORD N100E LCD
- TLFN145A THETFORD N145A LCD
- TLFN150A THETFORD N150A LCD
- TLFN175A THETFORD N175A LCD
- TLFN175AK THETFORD N175AK LCD FRAMELESS BLACK
- TLFRVENTW THETFORD STANDARD FRIDGE VENT
- TLFRCOVW THETFORD STANDARD FRIDGE VENT SPARE WINTER COVER
- TLFRVLRGW THETFORD LARGE FRIDGE VENT
- TLFRCOVLGW THETFORD LARGE VENT WINTER COVER
- TLFRVFAN THETFORD FRIDGE VENT FAN

	N80P	N100 E	N145A	N150A	N175A	N175AK
Dimensions H x W x D	821 x 486 x 543 mm	821 x 525 x 543 mm	1245 x 525 x 543 mm	1246 x 525 x 578 mm	1245 x 525 x 628 mm	1245 x 525 x 628 mm
Gross volume incl. freezer	81 liters	97 liters	141 liters	149 liters	175 liters	175 liters
Volume freezer	10 liters	11 liters	23 liters	25 liters	31 liters	31 liters
Wheel arch model	Yes	No	No	No	No	No
Door Type	Flat Framed	Flat Framed	Flat Framed	Curved	Curved Framed	Curved Black Frameless
Operation	Manual Piezo	Electric Energy Selection	Smart Energy Selection	Smart Energy Selection	Smart Energy Selection	Smart Energy Selection
Display	Flame indicator	LCD	LCD	LCD	LCD	LCD
Automatic defrosting cycle	No	Yes	Yes	Yes	Yes	Yes
Input 230V* (kWh/24h)	2.5	2.8	4	4	4	4
Input gas* (gr./24h)	300	330	420	420	420	420
Net weight	23 kilos	29 kilos	38 kilos	38 kilos	39 kilos	39 kilos

\* Average energy use at an ambient temperature of 25° C.

For higher temperature operation all 3 way fridges will benefit from the installation of a fridge cooling fan. We would recommend an FFT2 as the most suitable see page 48.

WE CAN SUPPLY ANY THETFORD REFRIGERATORS OR ACCESSORIES YOU REQUIRE. PLEASE CONTACT US WITH YOUR REQUIREMENTS.

**IMPORTANT NOTE: ALL GAS APPLIANCES MUST BE INSTALLED BY A QUALIFIED GAS ENGINEER. IF APPLIANCE IS DIY INSTALLED THE GAS INSTALLATION MUST BE INSPECTED FOR SAFETY BY A COMPETENT PERSON BEFORE USE.**

WE NOW OFFER INSTALLATION, GAS SAFETY TEST AND REPAIR SERVICE BY [SupremeTech.co.uk](http://SupremeTech.co.uk)



# WEBASTO DIESEL & AUXILIARY HEATING



## WEBASTO DIESEL/PETROL FIRED BLOWN AIR & SUPPLEMENTARY WATER HEATERS.

Regardless of the type of vehicle you use, webasto diesel powered heaters will meet all your needs.

- Easy to install maintain and operate.
- Economical to run, quiet operation.
- Powered from the vehicle's own fuel tank.
- Available as a comprehensive installation kit.
- Lower power consumption than comparable gas-powered blown air heaters.

## AIRTOP BLOWN AIR HEATERS

The webasto Airtop heater range now comes with a RV kit. Specifically designed for the Motorhome, Caravan, Horsebox & Specialist vehicle use, the RV kit is comprehensive. The Universal kit includes Airtop heater 12 volt and main electrical harness, Fuel pump, Fuel pipe & fuel pump wiring harness, 5 x 8 x 5mm fuel tee piece and connectors, 1m of exhaust duct, clamps & exhaust silencer, combustion air intake pipe, installation instructions & fastenings. The blown air output ducting and vents, if required, must be ordered separately. The RV kit has all the components of a universal kit with the addition of remote temperature sensor probe, rotary controller & floor mounting plate. The blown air output ducting and vents, if required, must be ordered separately.

- WBDA201** Airtop 2000 (2 kw) 12v one outlet universal kit
- WBDA201RV** Airtop 2000RV kit (2 kw) 12v no ducting or vents
- WBDA39** Airtop 3900 EVO kit (3.5 kw) 12v no duct or exhaust pipe
- WBDA50** Airtop 5500 EVO (5 kw) 12v kit no ducting or vents
- WBDACT** Combi timer upgrade with harness for airtop 2000 RV
- WBS1** 55 mm warm air ducting / metre
- WBS2** 55 mm warm air ducting clips
- WBS3** 55 mm warm air outlet
- WBS4** 55 mm warm air ducting Y piece
- WBFSP** Fuel pick up stand pipe (only with heater orders)

## THERMOTOP SUPPLEMENTARY HEAT SOURCE WATER HEATERS

If you want to be able to pre-warm the engine and heat water for domestic use as well as heat the interior of the vehicle, simply integrate a water heater into the coolant system. The unit works like a central heating system, warming up the coolant in the vehicle, passing it through the relevant heating system (calorifier, auxiliary blower or radiator) and then on to the engine. The temperature inside the vehicle is adjustable, and the warmth is distributed via the vehicle's own ventilation system or additional auxiliary blowers. What's more a pre-warmed engine prevents environmentally damaging cold starts and saves fuel. With their waterproof design, webasto heating systems can be installed almost anywhere in the vehicle. Installation of Thermo top kits will provide the heat source for radiators & auxiliary blown air heaters. For your kitchen and shower hot water needs the Nautic and Nautic XT calorifier water heaters (P122) will be heated by the Webasto or can be heated by their integrated electric immersion heaters when on site electric hook up.

- WBDTTE** Thermo top E 4kw 12v universal kit
- WBDTTC** Thermo top C 5kw 12v universal kit
- WBWS** Webasto rotary on/off switch
- WBFSP** Fuel pick up stand pipe (only with heater orders)

## AUXILIARY BLOWN AIR HEATERS

Link into webasto thermosystems for blown air heat output, or recover waste heat from the engine's cooling system via the units highly efficient heat exchanger. To provide just the right amount of blown air warmth to the cabin some units have a 3 speed fan. Ideal for inland boats, A class conversions for window demist, minibuses, PSV's, campers, special vehicle cabs and kit cars. When matched up with a thermal source such as a Webasto Thermo Top C diesel heater they provide blown air heating wherever required.

## COMPACT REMOTE AUXILIARY BLOWN AIR HEATERS

The heat exchanger is made from copper with aluminium radial fins, moulded ABS outer casing and tough ABS motor casing. The 'R' heaters have provision for 60mm hose duct outlets, to suit UR duct and matching ducting fittings. 'RP' have adjustable diffusers in fascia panel. Specifications. 260-261-263 models: 12V / 70w 6.5 A, Heat output 4,400 Kcal/hour, Air-flow 200/400m3 / hour. 265 model: 12V / 55w 4.5 A, Heat output 4350 Kcal/hour, Air-flow 200 m3 / hour. 245 model: 12V / 12w 1.0 A, Heat output 3000Kcal/hour (3Kw), Air-flow 110 m3 / hour.

- AXSR260** Sirocco 260 heater for 2 x UR duct connections. 260mm wide x 115mm high x 245mm deep.
- AXSRP261** Sirocco 261 heater & built in fascia 400mm x 180mm comes with fan switch, water temperature valve control & 2 directional air diffusers. Back casing 260mm wide x 115mm high x 275mm deep.
- AXSRP263** Sirocco 263 heater with 2 air diffuser outlets. 260mm wide x 115mm high x 245mm deep.
- AXSRP265** Sirocco 265 heater & smaller built in fascia with heat level & 3 speed fan controls and fixed air diffuser 269mm x 198 mm.
- AXSRP245** New compact Sirocco 245 heater, built in fascia with heat level & on-off single speed fan controls and fixed air diffuser. New flat compact fan housing to rear for installation in tight spaces and quieter operation. 269mm x 198 mm x 128 mm deep.
- AXSRSW** 3 position fan speed rotary selector switch.
- AXS271** WCV water flow valve to adjust temperature.
- AXS273** 5/8" (16 mm) heater hose reinforced rubber hose per mtr.
- AXS274** 5/8" (16 mm) metal t piece for system connection.

**MUST BE INSTALLED BY A WEBASTO QUALIFIED FITTER**

WE NOW OFFER INSTALLATION SERVICE BY [SupremeTech.co.uk](http://SupremeTech.co.uk)

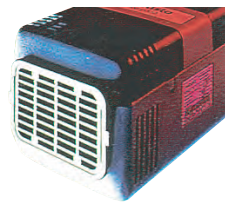

### Air Top 2000:

*The smallest air heater on the market, and so quiet you'll hardly know it's there. Ceramic technology and optimum cost-effectiveness make this the most powerful heater in its class. Thermostat as standard.*



### Air Top 3500 / Air Top 5000:

*Powerful, continuously adjustable temperature, compact and quiet, this heater is suitable for extreme conditions and will meet the highest demands. It saves space and can be installed easily in the cab or in the rear.*

### Thermotop C:

*The latest ceramic technology delivers maximum reliability, while high heat output, low power consumption and low fuel consumption make this a comfortable and cost-effective investment*



## RADIATORS FOR AUXILIARY WEBASTO HEATERS

Aluminium finned tube radiators approx. 75mm square various lengths available. Output 400 watts per metre.

- AXRAD400** RADIATOR 400 MM
- AXRAD700** RADIATOR 700 MM
- AXRAD1000** RADIATOR 1000 MM



AXSR260



AXSRP263

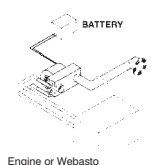

AXSRP245



AXSRP261



AXSR265



AXSRSW



AXS271



AXS273



AXS274

Heating

Buy securely online at [Leisurelines.net](http://Leisurelines.net)



0844 414 2324



0844 414 2425

# MINI XT & CARAVAN BOILERS



## Introducing the CAK Mini Boiler XT® water heater--the intelligent way to deliver more hot water.

This water heater provides the equivalent of 9 litres of hot water in a 6 litre size by heating cold water to a hotter temperature and then mixing it with more cold water through an already installed thermostatic mixing valve on the rear. The result is 50% more hot water! & compact dimensions for easier installation.

### NEW MINI 6XT & 10XT H<sub>2</sub>O<sub>T</sub> WATER HEATERS

Our New XT® Mini Boilers have been developed using eXothermal Technology and the principles of heat exchange to provide an electric water heater delivers 50% more hot water than standard water heaters without an increase in size or weight! XT® Mini Boilers are of a high quality construction with 100% copper water tank, for long term reliability and integrity. The XT® Mini Boilers come with a fully insulated outer case for efficiency enabling the boiler to retain heat for up to 24 hours. Powered by a 230-volt mains electric element of 500 or 750 watts, the Mini 6XT & 10XT will provide sufficient water for even the larger installations. Operating pressure 16-30 psi (1-2 bar), built in 2.5 BAR pressure relief safety valve, Adjustable thermostat set to 80°C max. Adjustable thermostatic mixer valve for water temperature outputs of 45°C to 65°C. Water connections for 15mm push fit, for PVC plumbing use NC448 15mm to 12mm straight reducing barbed connector.

#### MINI605XT MINI 6XT H2OT WATER HEATER 6 LITRE MAINS 500 WATT

Ultra Compact size of 440mm (17 1/4") long (Inc electric & water connections), 240mm (9 1/2") wide, 235mm (9 1/4") high. Water tank capacity 6 litre. Hot water production capacity 9 Litres approx. Dry weight 5.7kg

#### MINI1007XT MINI 10XT H2OT WATER HEATER 10 LITRE MAINS 750 WATT

Compact size of 575mm (22 5/8") long (Inc electric & water connections), 240mm (9 1/2") wide, 245mm (9 7/8") high. Water tank capacity 10 litre. Hot water production capacity 15 Litres approx. Dry weight 6.7kg

### NEW HEAT EXCHANGER VERSIONS OF MINI 6XT & 10XT WATER HEATERS

New version of water heater with the addition of copper heating coil (Calorifier coil) to connect heat source such as Webasto, Eberspacher or cooling water circuit of engine to provide hot water.

#### MINI605HE MINI 6XT H2OT WATER HEATER 6 LITRE WITH HEAT EXCHANGER MAINS 750 WATT

MINI1007HE MINI 10XT H2OT WATER HEATER 10 LITRE WITH HEAT EXCHANGER & MAINS 750 WATT ELEMENT

MINI1010HE MINI 10XT H2OT WATER HEATER 10 LITRE WITH HEAT EXCHANGER & MAINS 1000 WATT ELEMENT

### CARAVAN BOILER

The C.A.K. Tanks Caravan boiler is manufactured in four 22 litre and three 12 litre horizontal cylinder models with element sizes of 500, 800 and 1200 watts. The caravan boilers come as standard with an adjustable thermostat and a choice of mains electric element sizes of 500, 800 and 1200 watts. The energy efficient design and construction of the Caravan boilers enables quick heat up rates to provide a highly effective source of stored hot water to your pumped domestic water system. The larger 22 litre capacity provides a significant quantity stored water available on tap, the boilers are very simple to install requiring only electrical wiring, positioning and connecting to water system. No need to plumb in a gas system for hot water.

All Caravan models provide high levels of performance and efficiency and are equipped with the following additional standard features,

- Glass lined steel tank for strength & very long life.
- Strong stainless steel mounting saddle and brackets.
- Pressure release safety valve (4 bar + - 1).
- Magnesium anode protects boiler from galvanic currents.
- Boilers tested to 8 (bar) 200 % of operating pressure to ensure safety and product quality.
- High quality outer casing to protect thermally efficient polyurethane insulation jacket.
- Boiler element voltage 230 240 volt 50 hz. (22 litre model also available 110 Volt)

Due to the closed cell polyurethane foam insulation and outer casing the water temperature losses will be less than 1°C per hour. This enables water to be stored and remain warm for a longer period.

- 1, Cold water in ½" BSP male      2, Domestic hot water out ½" BSP male

PRODUCT SPECIFICATIONS BOILER MODEL	CARAVAN BOILERS						
	CB1205	CB1208	CB1212	CB2205	CB2208	CB2212	CB2211
HEAT EXCHANGER	NO	NO	NO	NO	NO	NO	NO
MAINS ELEMENT WATTS	500W	800W	1200W	500W	800W	1200W	1200W
VOLTAGE	230V	230V	230V	230V	230V	230V	110V
WATER CAPACITY LTR	12	12	12	22	22	22	22
WEIGHT KG	10	10	10	13	13	13	13
MAX LENGTH L1 (mm)	395	395	395	475	475	475	475
CASING LENGTH L2 (mm)	250	250	250	400	400	400	400
FIXING CENTRES L3 (mm)	175	175	175	300	300	300	300

### THERMOSTATIC MIXER VALVE FOR NAUTIC AND CARAVAN BOILERS

Our new Thermostatic mixer valve kit is manufactured in plated brass. Suitable for installation directly to the boiler with hose and connectors. The Mixer valve automatically adds cold water to the hot water being drawn from your water heater to prevent scalding water arriving at your tap. Those at greatest risk of scald injury include children, disabled and diabetics.

**Temperature Settings** – To prevent scalding, regardless of the water heating method or the control devices used; the temperature of the hot water supplied to taps and showers should be controlled in the range of 43°C – 60°C (110°F - 140°F) with fail-safe set at 82°C (180°F). **CAUTION:** Ideally the temperature should be set at 46°C (115°F) for health and safety reasons, higher settings will increase the risk of scald injury. Those at greatest risk of scald injury include children, disabled and diabetics.

**BBTMIXV THERMOSTATIC MIXER VALVE FOR NAUTIC AND CARAVAN BOILERS ¾" BSP**

**BBTMIXV12 THERMOSTATIC MIXER VALVE FOR NAUTIC AND CARAVAN BOILERS ½" BSP**

WE NOW OFFER INSTALLATION SERVICE IN KENILWORTH BY [SupremeTech.co.uk](http://SupremeTech.co.uk)

Ever wish you could have more hot water but didn't want a bigger, bulkier, heavier water heater? Now you can...

H<sub>2</sub>O<sub>T</sub>

eXothermal Technology XT



MINI605XT  
MINI107XT

CARAVAN BOILER CB2212



CARAVAN CB12

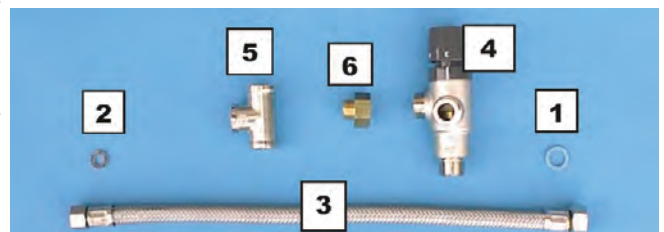
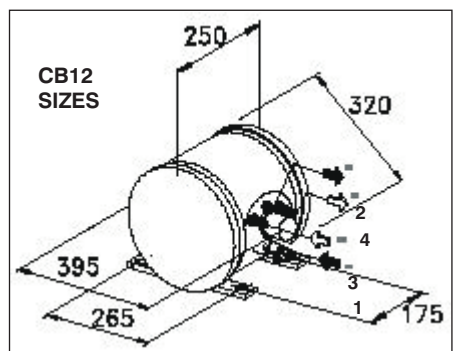
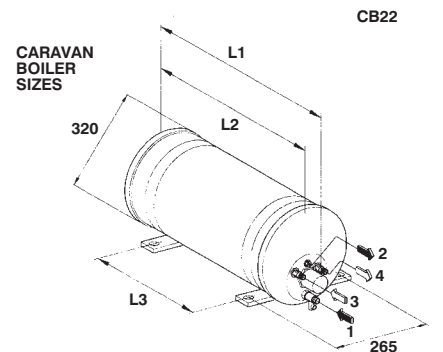

Heating

Buy securely online at [Leisurelines.net](http://Leisurelines.net)



# WHALE WATER & SPACE HEATERS



## Whale Gas & Electric Storage Water Heater

- Choice of settings – Fast heat up or low current draw
- One piece flue – No cover required
- Robust Insulation – Meets grade III EN1645-1
- 3 year Warranty

**Simple to use On/Off switch control functions – One model – 5 settings** Gas only - Electric low setting (WWH1302 600W/2.6A) (WWH0802 750W/3.25A) - Electric high setting (WWH1302 1200W/5.2A) (WWH0802 1500W/6.5A) - Gas and electric low - Gas and electric high.

Heat up times	Model	WWH1302	WWH0802
Approximate times	Gas Operation	43 mins	26 mins
	Electric Operation	38 mins	20 mins
	Gas & Electric Operation	22 mins	12 mins

**Minimal Wiring – 3 pin plug** - Simply plug in so no 230V wiring required.

**One Control Panel** - Includes easy to mount simple to use control panel. One 3.5m cable with simple connectors,

**Quick Connect Plumbing** - 12 mm Quick Connect Pre-assembled plumbing with adaptors for other pipework systems included.

**Maintenance** - Diagnostics system for easy fault finding and easily accessible components for servicing.



WWH1302

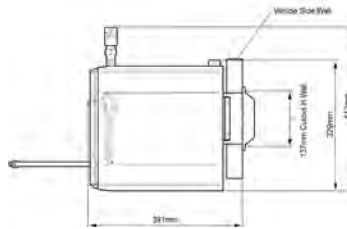

WWH0802 DIMENSIONS

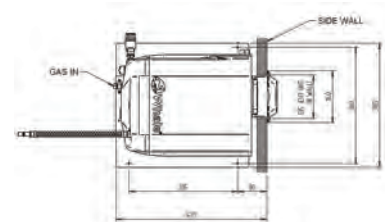

WWH1302 DIMENSIONS

## High Capacity - HOT WATER FOR LONGER

- Large 13L capacity hot water tank – more hot water
- Board Mounted Mounted on a board for quick and easy installation. The raised position allows pipes and wires to be housed underneath the heater for neat and compact installation

WWH1302 WHALE 13L HIGH CAPACITY WATER HEATER GE  
WWHAD2 CARVER FLUE PLATE ADAPTOR

## NEW Rapid Heat – COMPACT DESIGN, FAST HEAT UP TIMES

- Compact 8L capacity hot water tank – compact design saves space

WWH0802 WHALE 8L RAPID HEAT WATER HEATER GE  
Including adaptor plate

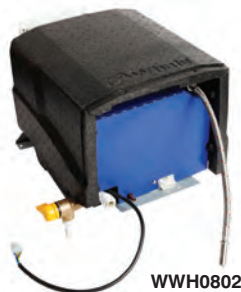

WWH0802

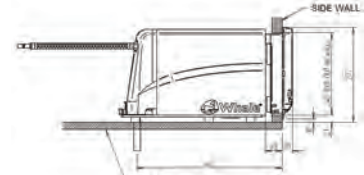
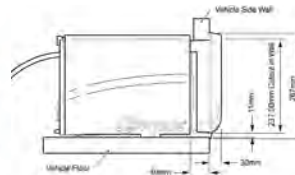

## NEW WHALE GAS & ELECTRIC SPACE HEATER

For Internal or Underfloor installation

**Frost protection setting** – To protect your caravan / motorhome in cold weather conditions

**Compact design** – Frees up valuable storage space – versatile and lightweight weighs only 6.3kg.

**Simple to use control panel** – 3.5M cable for mounting flexibility - Electronic temperature control – Electric settings 500W/1000W/2000W – Gas setting – Circulation fan setting.

**Energy efficient design** - requires only 2kW Gas or 2kW electric

**Full range of stylish & practical vents and Ducting fittings**

**Flue mounting flexibility** – Available in various lengths, 0.75m WFK2075, 1.25m WFK2125 & 2.00m WFK2200.

**Minimal Wiring – 3 pin plug** - Simply plug in so no 230V wiring required.

WSH2002 WHALE GAS & ELECTRIC SPACE HEATER  
WSH2012 UNDERFLOOR WHALE GAS & ELECTRIC SPACE HEATER

WFK2075 0.75m FLUE PIPE  
WFK2125 1.25m FLUE PIPE  
WFK2200 2.00m FLUE PIPE  
WDX6501 END BLANK CAP FITTING  
WDX6502 STRAIGHT FITTING  
WDX6503 TEE FITTING  
WDX6504 Y FITTING  
WDX6511 DIRECTIONAL CLOSEABLE OUTLET FITTING  
WDX6516 FIXED OPEN OUTLET FITTING



NEW

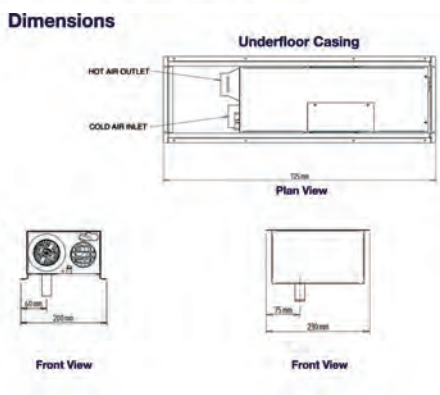
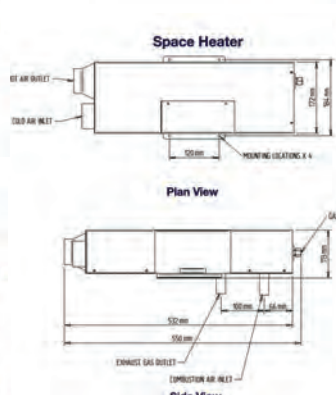
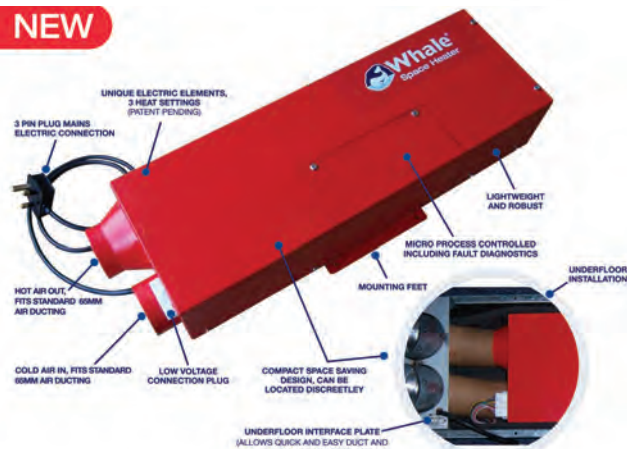

WE NOW OFFER INSTALLATION AND REPAIR SERVICE BY [SupremeTech.co.uk](http://SupremeTech.co.uk)



0844 414 2324



0844 414 2425

Heating

Buy securely online at [Leisurelines.net](http://Leisurelines.net)



# MALAGA WATER HEATER



## MALAGA MKIII G AND GE 13.5 LITRE STORAGE WATER HEATER

### A QUICK AND EFFICIENT SUPPLY OF HOT WATER

The Malaga MKIII is a high capacity storage water heater. The Malaga III heats water with an efficient gas burner, and the GE has the additional benefit of a 750-Watt mains electric immersion element. It can provide a quick and efficient hot water supply for touring caravans, motorhomes boats, horseboxes and specialist vehicles. Its compact dimensions make it most suited to panel van conversions, where its short inward length from sidewall flue ensures it fits most planned cupboard and seatbox sizes.

#### The Malaga MKIII is designed with many benefits.

- Larger 13.5 litre capacity for longer availability of hot water. (Cascade 9 lt., Jolly 10 lt., and Truma 10 lt.)
- Efficient gas burner - for faster warm up.
- 750Watt element – use it on its own or combined with gas operation for an even faster warm-up. ( operates independently of the gas functions so does not need to be connected until you are ready to use mains hook up later in conversion)
- Small flue terminal enables a neat installation.
- Room sealed combustion ensures safe operation.
- Easy to fit and service, all connections and circuit board are on the rear of the unit.
- All gas functions and 12volt electronic ignition is controlled by remote wall switch. New microprocessor electronic control, which has zero power consumption when idle, turns on the heater at the flick of a switch and supervises burner operation.
- Resettable high temperature thermal cut out, to ensure safety, just press a button to reset.

Will require fused water heater switch rated at 5 amp to control the mains element. Use CBE MCNF/G (on page 84) this matches the modular plates range of electrical switches.

The heater will operate with microswitched and pressurised water systems. The best pump to match with the Malaga is the Shurflo Trailking 7 16psi automatic pressure switched self priming diaphragm pump

#### MALWH MALAGA MKIII G 12V GAS ONLY

#### MALGE MALAGA MKII GE 12V GAS + MAINS ELECTRIC 750W ELEMENT

#### INSTALLATION REQUIREMENTS

- The heater should be floor mounted or suitably supported on a plinth
- The flue is designed to pass through a vertical section of the wall, structural sections of which should not be damaged.
- The flue terminal position should not be closer than 300mm below an opening window or 600mm from a vertical corner.
- Clearances required for installation and servicing as seen from inside the installation.

Left hand side	240mm	Right hand side	5mm
Rear	100mm	Top	5mm

#### TECHNICAL DATA

Dimensions	H 255mm	W 325mm	D 455mm
Weight empty	9.3 KG		
Water capacity	13.5 LITRES		
Water temperature thermostat	70°C		
Overheat safety thermostat	90°C		
Pressure relief valve setting	3 BAR		
Maximum working pressure	2 BAR		
Maximum pump supply pressure	1.3 BAR		
Gas supply			
Heat input	1.15 KW		
Gas consumption	84 g/h		
Gas supply pressure	Propane	37 mbar	
	Butane	28 mbar	
	Mixtures	30 mbar	
	Bray	960/40	
Injector			
Gas connection	8 mm PIPE		
Electrical supply (control)	12 V DC		
Mains immersion element	Input	750 WATT	
Mains electricity supply	220-240 V AC 50 Hz 5A FUSE		

THE MALAGA WATER HEATER RANGE IS CE APPROVED

The Malaga water heater has been tested and comply with the following: 90/396/EEC gas appliance directive, 89.336/EEC EMC directive, 73/23EEC low voltage directive. It is manufactured under ISO 9001:2000 plus annex 11.3 gas directive 90/396EEC.

## FLUE ADAPTOR PLATE FOR REPLACING CARVER CASCADE WITH MALAGA WATER HEATER

New product to enable easy replacement of the old Carver Cascade which is no longer in production. Enables you to upgrade to a larger capacity water heater without major surgery to the outside wall. The adaptor plate uses existing holes and covers up the existing sealant area leaving a neat finish with the Malaga flue terminal fitted to the adaptor plate

### MALAD FLUE ADAPTOR PLATE

**IMPORTANT NOTE ALL GAS APPLIANCES MUST BE INSTALLED BY A QUALIFIED GAS ENGINEER. IF APPLIANCE IS DIY INSTALLED THE GAS INSTALLATION MUST BE INSPECTED FOR SAFETY BY A COMPETENT PERSON BEFORE USE.**

WE NOW OFFER INSTALLATION, GAS SAFETY TEST AND REPAIR SERVICE BY [SupremeTech.co.uk](http://SupremeTech.co.uk)

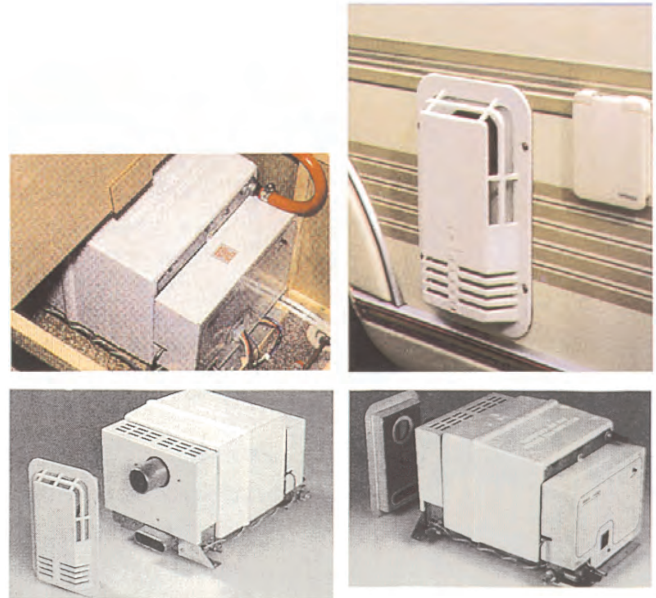

### Flue Fixing Template Details

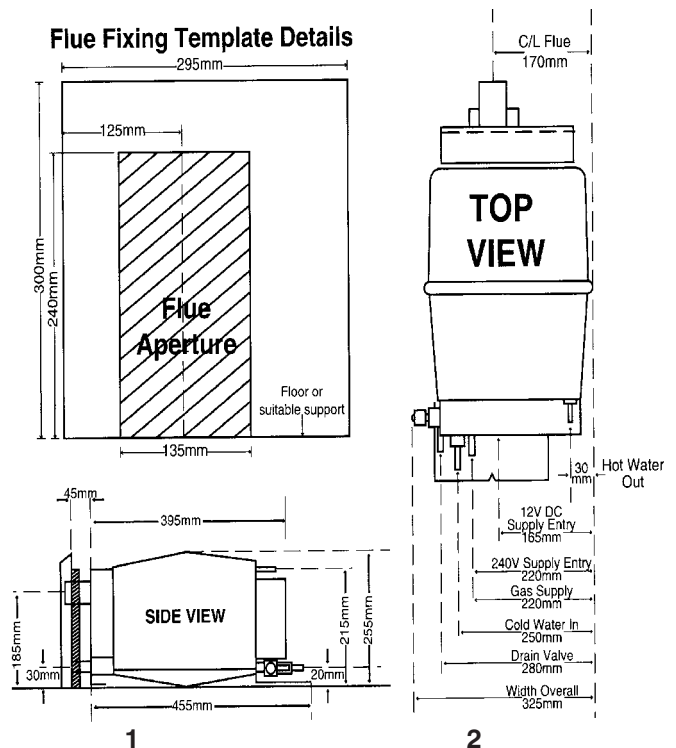

1. Malaga Flue Terminal



2. Flue adaptor plate (optional)



# HEATSOURCE BLOWN AIR CLIMATE CONTROL



The Heatsource 2000 & 2800 are automatic, thermostatically controlled blown air heating systems fuelled by Propane or Butane gas. Heatsource is designed for a variety of automotive and marine applications as a source of heat totally independent of the engine.

Combustion is of the forced air type, using a fan to draw air from the outside. This is then passed into the combustion chamber, where it mixes with gas and is automatically ignited by a spark. Gas is switched electronically with a solenoid valve, the flow controlled by a jet and the spark supplied by a high voltage ignitor housed within the heater. **Optional Digital timer available.**

Due to the design and efficiency of the stainless steel burner and heat exchanger, output is high, combustion is clean and all waste products are exhausted externally. Cabin air is usually re-circulated and drawn via the main fan, passed over the three surfaces of the heat exchanger and blown into the cabin through ducting and hot air outlets. Cabin air is totally sealed from exhaust gases. The unit is a room-sealed appliance and operates on propane or butane gas. Comprehensive installation kits supplied with each heater are listed below. Marine kits include combined inlet & exhaust through hull skin fitting.

**Compact size high output heater.**

**One of the quietest combustion heaters in production.**

**Designed for reliable, maintenance free operation.**

**Fast warm up time.**

**Airflow sensing detects blocked or restricted flue pipes.**

**Self-diagnostic fault finding with LED indication.**

ECONOMY	Heatsource 2000	Heatsource 2800
Average consumption	140 grams / hour	225 grams / hour
Calor 3.9 kg Propane	28.0 hours	17.5 hours
Calor 4.5 kg Butane	32.0 hours	20.0 hours
Calor 7 kg Butane	50.0 hours	31 hours
Calor 6 kg Propane	42.5 hours	26.5 hours
Calor 13 kg Propane	93.0 hours	58.0 hours
Calor 15.kg Butane	107.0 hours	67 hours
Camping Gaz 2.72 kg Butane	19.5 hours	12 hours

## PROPEX HEATSOURCE GAS BLOWN AIR HEATERS 2.0 & 2.8 kW

Blown air heaters offering 2.0 kW output running on 12 volt consume only 1.4 amps continuous running, gas usage only 140 grams per hour. Airflow 55 CFM. The 2.8 kW heaters running on 12 volt consume only 1.9 amps continuous and has gas usage of 225 grams per hour. **The 2.8kW heater is 420mm long x 210mm wide x 120mm high. Air throughput is 85 CFM.**

### HEATSOURCE ONE OUTLET KIT CONTENTS

Heatsource 2000w or 2800w heater - Thermostatic wall control with harness. - DC power harness. - 1 x Hot air outlet directional. - 1 m of Hot air ducting - 1 x Recirculation air vent - 0.2m Combustion air pipe. - 1m of Heater exhaust pipe. -1 kit of fastenings.

PX20112	PROPEX 2000 ONE OUTLET KIT 12 VOLTS
PX20124	PROPEX 2000 ONE OUTLET KIT 24 VOLTS
PX28112	PROPEX 2800 ONE OUTLET KIT 12 VOLTS
PX28124	PROPEX 2800 ONE OUTLET KIT 24 VOLTS

### HEATSOURCE 2 OUTLET KIT CONTENTS

Heatsource 2000w or 2800w heater - Thermostatic wall control with harness - DC power harness - 1 x Hot air outlet directional - 2 m Hot air ducting - 1 x open close air vent - 1 x Y piece - 1 x Recirculation air vent - 0.2m Combustion air pipe - 1 m Heater exhaust pipe - 1 kit of fastenings.

PX20212	PROPEX 2000 TWO OUTLETS KIT 12 VOLTS
PX28212	PROPEX 2800 TWO OUTLETS KIT 12 VOLTS

### MARINE KIT CONTENTS

The kit contents are the same as PX20112/212 and PX28112/212 with the addition of a combined stainless steel marine combustion air inlet & exhaust thru hull skin vent terminal. Also increase to 1 m of combustion air pipe.

PX20112M	PROPEX 2000 MARINE ONE OUTLET KIT 12 VOLTS
PX20212M	PROPEX 2000 MARINE TWO OUTLETS KIT 12 VOLTS
PX28112M	PROPEX 2800 MARINE ONE OUTLET KIT 12 VOLTS
PX28212M	PROPEX 2800 MARINE TWO OUTLETS KIT 12 VOLTS

### SPARE PARTS

PXSOCLOUT	PROPEX OPEN / CLOSEABLE DIRECTIONAL AIR VENT
PXSOUT	PROPEX OPEN LOUVRED AIR VENT
PXS80Y	PROPEX 80MM Y BRANCHE (REQUIRES REDUCERS)
PXS806RED	PROPEX 80MM TO 60MM REDUCER
PXS60DUCT	PROPEX 60MM BLOWN AIR DUCT PER METRE

### NEW PROPEX HEATSOURCE GAS & ELECTRIC AIR HEATERS

2.0Kw gas fired heater with the addition of a variable mains element with efficient heat exchanger built in. Three settings are available giving 500W, 1 KW or 2 KW of heat output and drawing a maximum current of 9 Amps. The motor speed is altered to suit each power level to ensure maximum efficiency or, when on low 500w setting keeping motor and air noise to a minimum for night time running.

PX20112GE	PROPEX 2000E GAS ELECTRIC ONE OUTLET KIT
PX20212GE	PROPEX 2000E GAS ELECTRIC TWO OUTLET KIT



2 8 0  
2 0 0



COMPACT UNDERFLOOR BLOWN AIR HEATER - See Page 57 for details

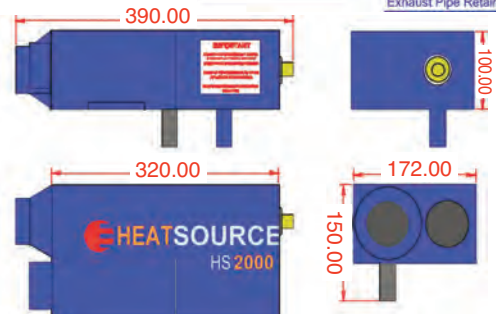
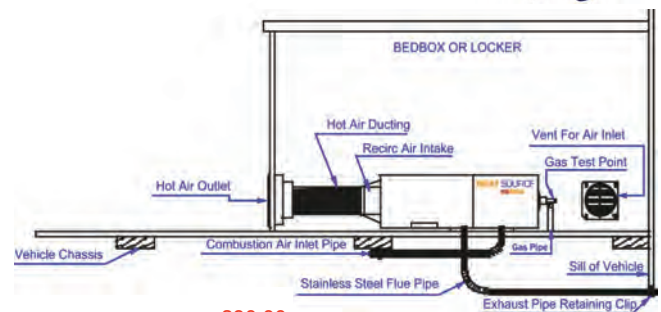

MARINE FLUE

PXS0CLOUT

PXSOUT



HEAT SOURCE GAS AND BLOWN AIR HEATER

WE NOW OFFER INSTALLATION SERVICE IN KENILWORTH BY [SupremeTech.co.uk](http://SupremeTech.co.uk)

0844 414 2324

0844 414 2425

Heating

Buy securely online at [Leisurelines.net](http://Leisurelines.net)



Heating

Buy securely online at Leisurelines.net

The Truma range of equipment will be found installed in many UK and Continental motorhomes.

### TRUMATIC S3004/ TRUMATIC S3004P

The Trumatic S3004 is available in manual Piezo ignition or with battery auto ignition models. It has many features: Built-in thermostat, Warm air is evenly distributed, Front case (order separately) available in Titan Silver or Pearl Grey, Economic gas consumption (approx 95% efficiency), Exhaust ducts through the roof (Roof Flue kit available as an optional extra), Rated thermal output: 3500 W, Gas Consumption: 30-280g/h, Front casing: Height from floor 545mm Width 500mm Depth 95mm, Rear installation box: Height 480mm depth 122mm, Weight: 9.8kg

**Front case and roof flue kit must be ordered separately. They are optional extras.**

- TR3138001** Trumatic S3004 with Automatic Ignitor, thermostat and installation box
- TR3129001** Trumatic S3004P with Piezo Ignitor, thermostat and installation box
- TR3042001** Front case Titan Silver for S3004
- TR3004050** Front case Pearl Grey for S3004
- TR3033000** Roof flue Kit comprises: Roof Flue AK3, 2.5m exhaust duct, 2m insulating duct & 3 clips.

### ULTRAHEAT UPGRADE

The Ultraheat upgrade provides the addition of 230v heating to your Trumatic S3002/S3004 gas heater. Three power settings (500W, 1000W & 2000W) for a level of heat that's just right for you, More efficient warm air distribution than with simple standing fan heaters, Heats up incredibly fast, whatever the weather, Simple installation - fits between the installation box and heat exchanger, Complete with thermostat, control panel and 3m connection cable, Weight: 2kg.

- TR3040202** Ultraheat kit

### TRUMATIC S2200

The compact Trumatic S2200 is available with the option of a 1.5 V auto igniter (Trumatic S 2200) or piezo igniter (Trumatic S 2200 P), current-free operation without installing optional fan, Heater available with exhaust duct connection on the left (standard) or right (on request), Exhaust duct through roof or wall cowl, Option of drawing in combustion air via the side wall (e.g. for use in containers or summer houses) Warm air is evenly distributed from 1850w output, Flexible installation thanks to compact dimensions. Economical gas consumption (approx. 95% efficiency).

- TRS2200P** Trumatic S2200 piezo
- TRS2200** Trumatic S2200 auto ignition

### TRUMA COMBI GAS-ELECTRIC

The Combi range provides combined water and air heating in a one box installation. Available in two models 4KW or 6KW providing large capacity units that can be used for blown air heating independently or for both heat and hot water at the same time. Features: Compact installation, 10 Litre water heating capacity in stainless tank, Integral fan for blown warm air, During winter operation, the vehicle is heated and the water is warmed up at the same time; during summer operation, only the water is warmed up, The heater can be operated even if the boiler hasn't been filled, Four warm air connections ensure optimum air distribution via a quiet yet powerful fan, The temperature can be infinitely adjusted on the ergonomic control panel, The current-free Frost Control safety/drain valve empties the boiler automatically if there is a risk of frost. 3m heater control panel cable, extensions available as extras. Heater is 12volt. Rear External Flue. Minimum installation dimensions. (L front to rear x W x H) 540 x 500 x 350 mm. **Requires exhaust flue ducting kit CW purchased separately.**

- TRCOMBI4E** 4kw Air and water heater with gas & 230v 1800w electric operation 33710-01
- TRCOMBI6E** 6kw Air and water heater with gas & 230v 1800w electric operation 33810-01

### TRUMA COMBI DIESEL

The efficient diesel version with burner technology from Eberspächer similar heat up times with dimensions to the gas version.

**Requires Wall cowl WKCD and pipe set CDW purchased separately.**

- TRCOMBI6D** 6kw Air and water heater with diesel burner 33500-01

### TRUMA ELECTROBOILER

Straightforward, fast installation, Full 14-litre capacity, Stainless steel container for ideal drinking water quality, Short heating times, High-performance 230v heating element with 850 W output, Lightweight - just 3 kg, 10mm water hose connections. Incl. control panel with 3 m cable & safety/drain valve. Heat up time 70min approx. Space required for installation: 45 cm diameter, 29.5 cm height

- TRELECTROB** 14 Litre Electroboiler 230v 850w 71200-01

### TRUMA THERME

Efficient use of heat from the hot air heating system & 230V heating element for a constant supply of hot water even if the heating is not switched on, Short heating times - in 230v 300w electrical operation - from 15°C to 60°C in 50 minutes, Water temperature infinitely variable up to 65°C, 5 litre capacity., Lightweight (just 2 kg) and compact. Incl. control panel, drain and breather valves.

- TRTHRMTT2** Truma Therme TT-2 (230V 300W 5 Litre)

### TRUMA ULTRASTORE BOILER B10 / B14

10 or 14 litre capacity in accordance with requirements, Fast water heating with powerful 1500 W gas burner, Absolute independence whilst on the move, Low gas consumption saves money, Space-saving design, Also available with an electrical heating element (850 W), Very short heating time (just 25 minutes in mixed operation), Stainless steel container for ideal drinking water quality.

- TRUTSB10** Ultrastore B10 gas only 73000-01
- TRUTSB10EL** Ultrastore B10 gas & electric 73400-21
- TRUTSB14** Ultrastore B14 gas only 73010-01
- TRUTSB14EL** Ultrastore B14 gas & electric 73410-21

**TRUMA SPARES** the full range of Truma ultraflow water connections, plug in pumps, waterlines and filters are available. As well as a full range of spare parts for the heating systems including cowls and ducting.



TRUMA S3004



TRUMA ULTRAHEAT



TRUMA S2200



TRUMA COMBI 4 & 6 E



TRUMA COMBI D



TRUMA ELECTROBOILER



TRUMA THERME TT-2



TRUMA ULTRASTORE



**IMPORTANT NOTE: ALL GAS APPLIANCES MUST BE INSTALLED BY A QUALIFIED GAS ENGINEER. IF APPLIANCE IS DIY INSTALLED THE GAS INSTALLATION MUST BE INSPECTED FOR SAFETY BY A COMPETENT PERSON BEFORE USE.**

**WE NOW OFFER INSTALLATION, GAS SAFETY TEST AND REPAIR SERVICE BY [SupremeTech.co.uk](http://SupremeTech.co.uk)**





## PORTABLE LOW WATTAGE ELECTRIC CONVECTION HEATER

### IGLOO 500 HEATER

This compact 500w electric convection heater is ideal for heating leisure vehicles while on 240v hook-up, or low heat while unit is in winter storage. It is also useful as a conservatory, greenhouse, summer house, site hut, aviary or garage heater. Heater is supplied with wall mounting bracket, and is easily unhooked to be stored away for extra space in the summer. It is of compact size with built in thermostatic control. Must be fixed to a wall. Not to be used as a free-standing heater.

SIZES: HEIGHT 380mm, WIDTH 160mm, and DEPTH 110mm.

**EHIGLOO** IGLOO 500W 230V CONVECTOR SPACE HEATER.



## BLOWN AIR FANS

Simply fitted to most convection heaters, they are designed to supplement the convection heating process by directing heat to colder areas to equalise the heating effectiveness. Set up the blown air system by using a mix of the below connectors and outlets to suit the need of your particular installation.

**TEB2** TRUMA TEB 12 VOLT FAN WITH REMOTE WALL CONTROL

**TEB2S35** TRUMA TEB 12 VOLT FAN FOR TRUMATIC S3002 S5002

## TRUMA AWNING KIT

New kit to allow easy provision of warm air into the awning. Complete with exterior terminal ducting, connectors and remote shut off.

**G-AWNKIT** TRUMA AWNING KIT BLOWN AIR EXTENSION KIT

## BLOWN AIR DUCTING AND FITTINGS.

The industry standard ducting and fittings used on most installations. The Truma blown air fittings will inter change with the older Carver system in all cases. The range of fittings allows simple installation of extensions to existing systems or the addition of a new system with a Truma TEB2 fan and a range of duct and fittings. The new design fittings are all grey behind the facia apart from air outlets where there is a choice of colour.

- G-BT** BT SIDE OUTLET ( REQUIRES EN AIR OUTLET )
- G-DR** DR WATERPROOF OVERDUCT / MTR
- G-EN** EN STRAIGHT AIR OUTLET BEIGE
- G-ENG** EN STRAIGHT AIR OUTLET LIGHT GREY
- G-ENW** EN STRAIGHT AIR OUTLET WHITE
- G-EM** EM NUT FOR EN TO MAKE END OUTLET
- G-SP** BRANCH PIPE SHUT OFF VALVE
- G-SP2** BRANCH PIPE BOWDEN CABLE SHUT OFF VALVE
- G-UM** UM STRAIGHT CONNECTOR FOR UR DUCT
- G-UR** UR DUCTING 65mm OD / MTR
- G-US** US CLIPS FOR UR DUCTING
- G-UT** UT TEE PIECE FOR UR DUCT
- G-VD** VD BLANKING PLUG
- G-WL** WL WALL VENTILATOR
- G-Y** Y PIECE FOR UR DUCTING

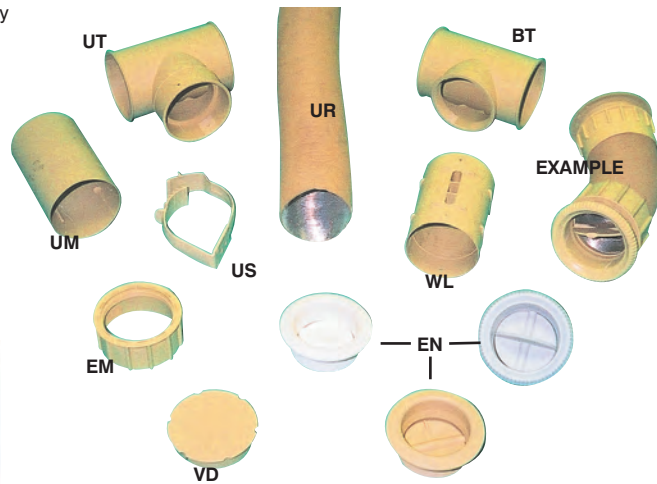

**ELHPTC30012** 12VOLT 300W CERAMIC HEATER



## NEW COMPACT UNDERFLOOR BLOWN AIR HEATER

The Propex PX2211 heater is designed for mounting the unit underneath the vehicle; various bracket fixings allow different positions and orientations for mounting, increasing fitting options under the floor or up between chassis rails.

The PX2211 is supplied with a surface mount electronic wall thermostat. When the room temperature drops below the selected level, the Heatsource will automatically ignite and run until the cabin reaches the selected temperature.

The PX2211 can be supplied with complete fitting kits to suit underfloor installations, with kits available to cover the number of outlets required. In vehicles and caravans the unit is usually mounted under the floor or between chassis rails, with some vehicle specific mounting kits available, the combustion pipes are then lead out to the side of the vehicle. The low profile design of the heater means no pipes or easily snagged parts are left exposed and so maintaining the ground clearance of the vehicle. The heat is ducted to one or more outlets through tough highly flexible 60mm ducting and up into the vehicle in your preferred location. The ducting runs outside the vehicle should be run inside insulated ducting to minimise heat loss. In the case of multi-outlet installations, the first outlet is an open outlet with directional control and the rest are closable and are used in conjunction with the appropriate sized plastic Y-branches. The heater is made from corrosion resistant materials and sealed against the ingress of water; however suitable provision should be made to protect the heater from direct road spray and debris.

Model: PX2211 Maximum dimensions: Height: 230mm, Width: 157mm, length: 430mm; Weight Under-floor Installation 7.7kg; Butane/Propane Gas Consumption (M) 150g/h Nominal Heat Input: Gas 2.0Kw; Nominal voltage: 12V dc; Maximum current dc gas operation: 1.7 Amps (0.01Amps on standby) ; Hot Air Duct Diameter: 60mm ID ; Flue Diameter: 22mm ID Maximum Exhaust Flue Length: 2m ; Minimum Exhaust Flue Length: 0.75m Maximum Combustion Air Flue Length: 2m ; Minimum Combustion Air Flue Length: 1.0m.

**PX221112-1** Propex 2211 underfloor heater one outlet kit.



**PXBRKTVM** Propex Vehicle in Motion Bracket . for all 2000 models of Propex heater allowing heater to be used while vehicle is driving.



**PXBRKTVM**

**IMPORTANT NOTE ALL GAS APPLIANCES MUST BE INSTALLED BY A QUALIFIED GAS ENGINEER. IF APPLIANCE IS DIY INSTALLED THE GAS INSTALLATION MUST BE INSPECTED FOR SAFETY BY A COMPETENT PERSON BEFORE USE.**

**WE NOW OFFER INSTALLATION SERVICE BY [SupremeTech.co.uk](http://SupremeTech.co.uk)**



**0844 414 2324**



**0844 414 2425**

**Why struggle connecting, lifting and carrying heavy gas bottles and then pay 50% more for the gas than you have to? ...BECAUSE YOU ALWAYS HAD TO! Then when you travel to Europe and you run out of gas, it becomes a nightmare as you cannot exchange your empty cylinder for a full one....BECAUSE THAT'S THE WAY IT IS! NOT ANY MORE....Fit a Gaslow refillable!**

The Gaslow Refillable cylinders have been designed in 6Kg and 11Kg sizes specifically to fit all Caravans and Motorhomes. They are the only ones to be European Approved and carrying a full 15 year warranty on the complete system, including the non-rubber, stainless steel filler hoses.

For complete safety, the specially designed and European Pi approved Filler Valves automatically shut off the gas when the cylinder is 80% full – preventing the dangers associated with overfilling.

You can just pull up at one of the thousands of Autogas Service Stations throughout the UK and Europe and fill up just like your car! If you have a twin cylinder system, not only will it fill up the empty but top up your nearly full one at the same time - you simply pay for what you use.

Try the system with one cylinder – using your standard cylinder with it. You can easily add a second Gaslow Refillable at any time, as it needs no installation. When you come to replace your Van you have the simple option of taking the whole system with you!

### GASLOW REFILLABLE CYLINDERS

The refillable cylinders come as cylinder 1 or 2 for a single installation choose cylinder 1. When you wish to add a second cylinder choose cylinder 2, this has the double fill thru connection to join to your cylinder 1 for refilling require joining hose.

- GRFC4006** 6Kg Cylinder 1 - 11.5 litres (80%) H 492mm x dia246mm
- GRFC4011** 11Kg Cylinder 1 - 21 litres (80%) H 580mm x dia304mm
- GRFC40062** 6Kg Cylinder 2 - 11.5 litres (80%) H 492mm x dia246mm
- GRFC40112** 11Kg Cylinder 2 - 21 litres (80%) H 580mm x dia304mm

### GASLOW UK AUTOGAS FILLING KITS

Filling kits complete with mounting bracket in white or black finish together with screws for mounting on the side of your caravan or motorhome. Connection to the cylinder(s) is with the super safe rubber-free Stainless Steel 1.5 metre flexible hose with 3/4" UNF connections. Compatible with refill adaptors **GT630** for Europe & **GFRIT** for France & Italy. These adaptors simply screw into your UK fill point converting it to European filling systems

- GRFC4100** Filling Kit - White                      **GRFC4106** Filling Kit 0.6m - White
- GRFC4150** Filling Kit - Black                      **GRFC4156** Filling Kit 0.6m - Black

### SECOND CYLINDER CONNECTION HOSE

Turning a single cylinder system into a twin by adding a Cylinder 2 could not be easier. This 0.6metre special Stainless Steel hose with 3/4" UNF connections simply connects the Gaslow Cylinder 1 and Cylinder 2 together. When you go to fill up, both cylinders will be automatically filled.

- GRFC4200** 2nd Cylinder 600mm Connector Hose

### SECOND CYLINDER ELBOW FILL ADAPTOR

Used when cylinder headroom in the gas locker is a problem

- GRFC4210** 2nd Cylinder Elbow Fill Adaptor

### CONNECTING TO THE REFILLABLE GAS SUPPLY

To use the gas, the valve which you connect to is the same screw type as used on the Calor 4.5Kg Butane cylinder 21.8 LH. Autogas is Propane - If you are already using Propane you can convert your existing regulator with a Propane Adapter and Gauge (**GRFC4330**). For pre-2004 vans using Butane, you will need to change your regulator and fit one of the following: Propane Manual Changeover (**GRFC1650RFL**), Propane Auto Changeover (**GRFC1655RFL**). If you have a Propane changeover **GCORE92**, simply change the high-pressure pigtail hoses to **GPTB26** or **27**. For new vans fitted with a 30mbar caravan regulator and using 7Kg Butane cylinders, simply remove the clip-on adapter. If using Propane, change the high-pressure hose(s) to a **GPTB26** or **27**.

Imported vans with German regulator connections will fit directly on to the refillable cylinder (washer required):

For brand new installations use the EN1949 regulator system from on page 60 (**GREG5248-10, GCVAD8, GPTB26** or **27** & **GCORE 92**)

### NEW DIRECT FILL GASLOW CYLINDERS

Direct fill cylinder kits include fitted to cylinder direct fill Adaptor & a propane regulator to match the 21.8LH gas outlet for portable BBQ use. This cylinder can be used in a Motorhome or Caravan by connecting your 21.8LH Butane type pigtail to cylinder.

- GRFC4006DF** DIRECT FILL 6KG CYLINDER KIT
- GRFC4011DF** DIRECT FILL 11KG CYLINDER KIT

### LOCAL CYLINDER CONNECTION HOSE

Home or abroad and you can't get to a filling point.... now you can use the local cylinders!

Screw the connection hose into your Gaslow Filler and now you can connect any 21.8LH UK or foreign cylinders or adapters...(see Below & Page 60).

When in use, you will be drawing gas through one of your refillables.

IMPORTANT - This will NOT transfer the liquid gas to your refillable cylinder. When the added cylinder is empty - so is the refillable you're using.

- GRFC4500** LOCAL CYLINDER CONNECTION HOSE

### FOREIGN CYLINDER ADAPTORS

Simply screws on to your 21.8LH Gaslow or BUTANE pigtail hose to fit that countries cylinder.

- GCYADSWBL** SWEDISH/BELGIAN CYLINDER ADAPTOR
- GCYADDUGM** DUTCH/GERMAN CYLINDER ADAPTOR
- GCYADGKIT** GREEK/ITALIAN CYLINDER ADAPTOR

WITH CONTENTS GAUGE



We can supply any Gaslow product. Please enquire



FILLING KITS

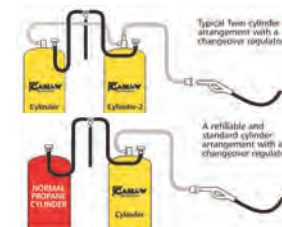

GRFC4006DF Being Filled



GCYADSWBL



GCYADDUGM



GCYADGKIT



GRFC4200

GRFC4210



GRFC4500

WE NOW OFFER INSTALLATION, GAS SAFETY TEST AND REPAIR SERVICE BY [SupremeTech.co.uk](http://SupremeTech.co.uk)

## LPG BUILT IN HORIZONTAL GAS TANKS

Built in propane gas tanks provide the convenience of larger gas storage quantities without the difficulties of lugging heavy bottles in and out of small lockers for refilling. By having the ability to buy bulk LPG liquid gas you will save money, as bulk gas is much cheaper than buying it in a usual refillable bottle. Refilling your gas tank is as easy as filling up your vehicle tank with fuel, only much cheaper. There is a UK and Europe wide network of gas refilling stations with the numbers growing weekly. This makes supply of gas in any country so much easier than carrying numerous alternative bottles for each country you visit. Our red tanks are designed for vapour offtake to provide gas for domestic equipment (cooking and heating etc.). Our red tanks are not suitable for engine gas conversions; these require a liquid offtake black gas tank, which we do not supply. **GAS TANKS CAN BE DIY INSTALLED BUT SHOULD BE TESTED AND COMMISSIONED BY A QUALIFIED LPG GAS ENGINEER BEFORE USE.-**

### BUILT IN HORIZONTAL VAPOUR OFF-TAKE (4 HOLE) GAS TANK & MOUNTING KIT

TANK CODE	MOUNT FRAME	CAPACITY LTR	DIAMETER	LENGTH
GT020-200-717	GT020-200 FRAME	20	200	717
GT023-230-630	GT023-230 FRAME	23	230	630
GT025-200-884	GT025-200 FRAME	25	200	884
GT030-200-1052	GT030-200 FRAME	30	200	1052
GT030-270-607	GT030-270 FRAME	30	270	607
GT038-230-1014	GT038-230 FRAME	38	230	1014
GT040-270-792	GT040-270FRAME	40	270	792
GT040-300-646	GT040-300FRAME	40	300	646
GT055-270-1069	GT055-270FRAME	55	270	1069
GT055-360-632	GT055-360FRAME	55	360	632
GT060-300-940	GT060-300FRAME	60	300	940
GT060-315-869	GT060-315FRAME	60	315	869
GT070-300-1088	GT070-300FRAME	70	300	1088
GT070-315-1004	GT070-315FRAME	70	315	1004
GT085-360-944	GT085-360FRAME	85	360	944
GT100-360-1099	GT100-360FRAME	100	360	1099
GT116-360-1265	GT116-360FRAME	116	360	1265

**GT038-230-1014 TANK HAS FLOOR FIXING FEET WELDED TO TANK**

Capacity is water capacity gas literage will be 80% of this due to safety fill valve.  
A 60 litre tank would have a gas weight at 5° C, 80 % fill capacity of 25.3Kg. Plus tank empty weight of 32kg.











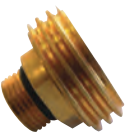

GRB06G

GRB11G

## GAS IT RED REFILLABLE BOTTLES (2 HOLE)

Same design and dimensions as gaslow number one bottle just now in red.

**GRB06G** GAS IT REFILLABLE 6KG BOTTLE WITH GUAGE  
**GRB11G** GAS IT REFILLABLE 11KG BOTTLE WITH GUAGE

				
<b>GTEUK</b> Adaptor converts GT630 to suit some UK filling stations	<b>GFRIT</b> Adaptor for refilling in France and Italy	<b>GSPAN</b> Adaptor for refilling in Spain	<b>G643</b> Adaptor for filling from bayonet nozzle.	<b>GT622</b> Remote electronic level indicator. 12 volt. 4 HOLE TANKS BOTTLES ONLY.
				
<b>GT630</b> Europe standard filling quick connector	<b>EXTERIOR 70mm fill box</b> <b>GTFFILLBXK</b> Black <b>GTFFILLBXW</b> White	Remote fill point JIC Fast Fill connecting hose <b>GT621150</b> 1.5 mtr <b>GT621125</b> 1.25mtr <b>GT621050</b> 0.5 mtr	<b>GT620</b> Exterior Remote filling point elbow	<b>GT623</b> Exterior Remote filling point straight
				
<b>GRBLFKANG</b> Remote In Locker fill point with angled bracket and 0.5m fast fill JIC hose	<b>GRBLFKSTR</b> Remote In Locker fill point with straight bracket and 0.5m fast fill JIC hose	<b>GRBTWINFILL</b> 2nd bottle fill tee and JIC fast fill hose	<b>GRB611KIT</b> 6kg & 11kg kit	Twin 11kg or 6kg kit <b>GRB1111KIT</b> Twin 11kg <b>GRB66KIT</b> Twin 6kg

This is just a selection of our stock range. We offer an extensive range of gas tanks and refillable bottles please check our shop or website for more info. Or send us an email with your requirements.

WE NOW OFFER INSTALLATION, GAS SAFETY TEST AND REPAIR SERVICE BY [SupremeTech.co.uk](http://SupremeTech.co.uk)



0844 414 2324



0844 414 2425

## THE EN1949 REQUIREMENTS

EN 1949 is the new standard for the installation of LPG into touring caravans & motorhomes. Amongst other requirements, EN1949 harmonises - across Europe - the installation of LPG in touring caravans and motorhomes. From the 2004 season onwards (vehicles manufactured from September 2003), your new Caravan or Motorhome will be supplied ready-fitted with a special bulkhead mounted regulator (**GREG524**), labeled 30mbar, which has attached to it a "pigtail" (**GPTP25** or **GPTB27**) connector for UK LPG cylinders. This ensures not only that you have the correct regulator at the correct pressure for your LPG powered appliances, but also that it is checked along with the rest of the installation as part of the manufacturer's gas safety checks. When traveling in Europe for a safe connection to a European cylinder, you will need to obtain a "pigtail", "pigtail to bottle adaptor" or "foreign cylinder adaptor" that fits the cylinders available in that country (see below or page 58). Simply connect adaptor to the end of an existing Butane 21.8 LH UK "pigtail" while you are using the European cylinder. When you want to change back to the UK cylinder, simply swap the pigtail or adaptor back again. Therefore you no longer need to replace the regulator. An easier option is to install Gaslow refillable cylinders. They stay in your gas compartment and are refilled at normal fuel filling stations from their Autogas pumps.

## THE EN1949 REGULATOR SYSTEM FROM C.A.K.

The bulkhead mounted fixed regulator **GREG524** has a capacity of 1.5kg/hour and operates at 30mbar. The inlet connection is a standard W20 thread, outlet connection is for 8mm or 10mm copper pipe. For the inlet you need a pigtail assembly that fits your cylinder connection. For propane you need pigtail **GPTP24** or **25** and for butane you need pigtail **GPTB26** or **27**. With this you now have a standard EN1949 regulator kit.

**GREG5248** 8mm EN1949 FIXED REGULATOR 1.5KG/HR 30MBAR (A)  
**GREG52410** 10mm EN1949 FIXED REGULATOR 1.5KG/HR 30MBAR (A)

**GPTP24** CYLINDER PIGTAIL POL PROPANE 750MM (C)  
**GPTP25** CYLINDER PIGTAIL POL PROPANE 450MM (C)  
**GPTB26** CYLINDER PIGTAIL 21.8LH BUTANE 750MM (D)  
**GPTB27** CYLINDER PIGTAIL 21.8LH BUTANE 450MM (D)  
**GPTP6060** CYLINDER PIGTAIL POL PROPANE 1000MM (C)  
**GPTP6065** CYLINDER PIGTAIL POL PROPANE 1500MM (C)  
**GPTB6030** CYLINDER PIGTAIL 21.8LH BUTANE 1000MM (D)  
**GPTB6035** CYLINDER PIGTAIL 21.8LH BUTANE 1500MM (D)

## STAINLESS STEEL PIGTAILS

An alternative to the standard rubber/pvc pigtails is to fit stainless steel versions with a 20 year service life. Butane 21.8LH connection, PROPANE POL

**GSPT6010B** STAINLESS PIGTAIL 21.8LH BUTANE 450MM  
**GSPT6020B** STAINLESS PIGTAIL 21.8LH BUTANE 750MM  
**GSPT6035B** STAINLESS PIGTAIL 21.8LH BUTANE 1500MM  
**GSPT6036B** STAINLESS PIGTAIL 21.8LH BUTANE 2000MM  
**GSPT6040P** STAINLESS PIGTAIL EASYFIT PROPANE 450MM  
**GSPT6050P** STAINLESS PIGTAIL EASYFIT PROPANE 750MM

## PIGTAIL TO BOTTLE ADAPTORS

PIGTAIL TO BOTTLE ADAPTORS

These adaptors will allow various bottles to be attached to fixed regulator using the Standard 21.8LH Butane pigtails. The 21mm clip on is the standard clip on for 7 & 15kg Calor. 20mm for some UK bottles & 6kg ELF, MALICE & TWINNY in France. 27mm fits BP Gaslite Patio Gas & BBQ Gas in the UK. 27T 27mm fits French Le Cube and some Portuguese cylinders as well as BP Gaslite Patio Gas & BBQ Gas in the UK. Jumbo Adaptor connects to Norwegian, Spanish, Portuguese & Southern Irish cylinders.

**GCYADG** ADAPTOR BUTANE PIGTAIL TO CAMPING GAZ (E)  
**GCYADC** ADAPTOR BUTANE PIGTAIL TO CLIP ON CYLINDER 21MM (F)  
**GCYADC20** ADAPTOR BUTANE PIGTAIL TO CLIP ON CYLINDER 20MM (F)  
**GCYADC27** ADAPTOR BUTANE PIGTAIL TO CLIP ON CYLINDER 27MM (F)  
**GCYADJBO** ADAPTOR BUTANE PIGTAIL TO JUMBO CLIP ON CYLINDER (G)  
**GCYADC27T** ADAPTOR BUTANE PIGTAIL TO ELBOW TOP CLIP ON CYLINDER 27MM (J)

## AUTOMATIC CHANGEOVER UNIT FOR TWO BOTTLES

As an option you can add an automatic change over unit **GCORE92** to the top of your EN1949 regulator. To fit this unit you will need one pigtail for each of the bottles in use. W20 threads in W20 nut to connect to regulator. **GCORE92** AUTOMATIC CHANGE OVER UNIT(H)

## MANUAL CHANGEOVER UNIT FOR TWO BOTTLES

An alternative option is to add a manual changeover block with a built in gaslow contents gauge. To install this you will need one pigtail for each of the bottles in use. W20 threads in W20 male threads in from pigtails W20 female nut to connect to regulator.

**GRFC1630RFL** MANUAL CHANGE OVER & GASLOW GAUGE  
**GLG1625B** MANUAL CHANGE OVER GAUGE BUTANE

## GLG5050 SWITCH 2 MANUAL CHANGEOVER IN HOSE

For pre-2004 models, this is an alternative twin gas cylinder connection system which uses your existing regulators. It is designed for the low-pressure side of your gas system after your regulators. The two supply inlets are controlled by a two-way tap and can use either type of LP gas - one side can be Propane, the other side Butane. Switch-2 makes changeover easy and allows the empty cylinder to be removed without switching off the supply. It is supplied with 3 hose clips and is fitted with a mounting bracket.

## GAS OUTLET BOX WITH VALVE & QUICK CONNECTOR

To meet the requirements of EN1949 for manufacturers a new gas outlet box has been developed. The new outlet box contains our quick connector gas tap **GQCT8**. If you don't wish to cut through your sidewall then a **GQCT8** can be fitted into a locker to provide the gas outlet. This change is to meet the requirements of secondary isolation on the gas when quick connect hose is disconnected. Our original **GEOB8** gas outlet box can still be fitted by DIY converters and as a replacement unit. Hose tail quick connector to be ordered separately.

**GTOB8** GAS OUTLET BOX EN1949 WITH QUICK CONNECTOR & VALVE  
**GTOBCN8** HOSE TAIL QUICK CONNECTOR FOR GTOB8

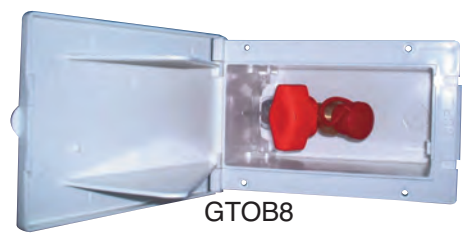
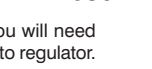
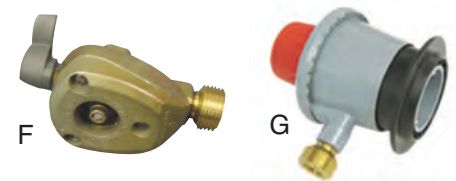
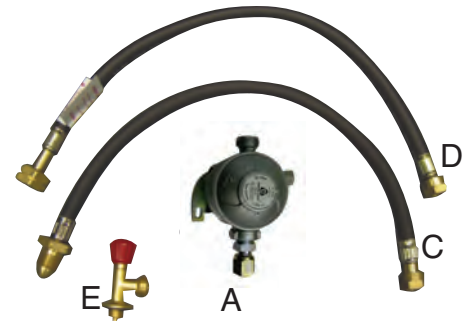

Gas

Buy securely online at Leisurelines.net

WE NOW OFFER INSTALLATION, GAS SAFETY TEST AND REPAIR SERVICE BY [SupremeTech.co.uk](http://SupremeTech.co.uk)

ALL STANDARD GAS FITTINGS ARE 8 mm PAN EUROPEAN EN DIN SPECIFICATIONS. Imperial 5/16" / 8MM IS COMPATIBLE TO MIX WITHIN A SYSTEM. 10mm is a special size and not widely used.



**GPC810** 8MM Copper gas pipe.  
**GPC810CW** 8MM Copper gas pipe. Outer sleeved for external use.



**GSTR8** Straight 8mm  
**GELB8** Elbow 8mm  
**GTEE8** Tee 8mm  
**GSTR10** Straight 10mm  
**GELB10** Elbow 10mm  
**GTEE10** Tee 10mm



**GCHN8** 6mm hose barb x 8mm olive fitting  
**GBHC8** 8mm hose barb x 8mm olive fitting



**GBARB8** Straight 8mm barb fits any fitting or valve with 8mm olive to allow GHP8 hose to be connected



**GBHC8** Bulkhead connector 8mm olive x 8mm hose barb. Secure with p clip.

## GAS BOTTLE REGULATORS



**GSTUD8** 8MM straight stud connector.



**GRP37** PROPANE + NOZZLE OUTLET 37mbar 1.5 Kg/h  
**GRP374** Propane 4 kg/h



**GRB30** BUTANE + NOZZLE OUTLET 30mbar 1.3 Kg/h



**GRCG** CAMPING BUTANE 30 mbar 0.8 Kg/h



**GHP8** High quality 8mm gas hose orange 20 bar high pressure



Gas bottle retainer.  
**G80461** Wall bracket.  
**G80462** Belt + buckle.



**GVST** Set of symbol stickers for valve identification



**GV8** straight valve (8mm)  
**GV10** straight valve (10mm)  
**GVB2** manifold valve 2 way (8mm)  
**GVB3** manifold valve 3 way (8mm)



**GVMB** Mounting bracket for gas valves



**GVB4** MANIFOLD 4 WAY  
**GVB5** MANIFOLD 5 WAY (8mm)

Gas leak detector spray simple spray test to check for small gas joint leaks. Easy to use, essential safety check, special non flammable product for leak testing and pressurised piping.

**GLS400** Gas leak detector spray 400ml aerosol  
**GLS100** Small Gas leak detector spray 100ml aerosol



Gas joint sealing compound. Sealing compound to guarantee gas joints will seal properly preventing gas leaks.  
**GJSC** gas joint sealing compound 5g tube.



Safety valve and pressure gauge provides easy visual leak and bottle level check.  
**GSVB** For Butane (pictured left)  
**GSVP** For Propane (pictured right)



Magnetic gas level indicator attaches to lower portion of cylinder. Crystals change colour as gas level changes. Also indicates temperature of cylinder.  
**GCHK** Gas check™ gas level indicator



**GEOB8** External gas outlet box with quick connector. Order separately the required hose nozzle see right.

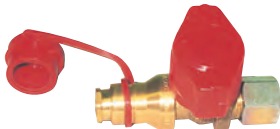

**PLUG IN GAS OUTLET VALVE** 8MM  
**GQCT8** Quick connect tap outlet + protection cap 8mm



**GQCN6** Quick connect hose nozzle for 6mm id gas hose  
**GQCN8** Quick connect hose nozzle for 8mm id gas hose



**GVBN** Blanking nut for manifold valves  
**GBO** Spare brass 8mm olive for valves & connectors



**GPC1010** 10MM Copper gas pipe. (SPECIAL SIZE)  
**GPC1010W** 10MM Copper gas pipe. Outer sleeved for external use.



**GPBEND** Gas pipe bender for 6, 8 & 10mm copper pipe.



**GPBTC** Mini tube cutter smooth cutting on 3-22mm copper pipe



**GLPGWS** LPG WARNING STICKER. It's a requirement to be affixed to gas locker external door or on outside of vehicle where gas is stored, warning that LPG gas is carried on board.



**GPTSHD**



**GPTSS**

**GPTSS** Standard pressed steel bottle spanner  
**GPTSHD** Heavy duty professional forged bottle spanner



10mm to 8mm reducer fittings  
**GSTR810** Straight Reducer  
**GELB810** Elbow Reducer  
**GBO10** 10MM Olive  
**GTEE10810** Converter 10mm tee side olive is 8mm

WE NOW OFFER INSTALLATION, GAS SAFETY TEST AND REPAIR SERVICE BY [SupremeTech.co.uk](http://SupremeTech.co.uk)



0844 414 2324



0844 414 2425

## GAS BOTTLE BASE HOLDER

Designed for use with our bottle holder and straps G80461/2 page 61 to ensure there is no movement. They are designed to accommodate most types of gas bottle; The Calor gas type bottle sits inside the top recess and the 2 inner recesses. The BP gas lite bottle sits inside the top recess and the 2 outside recess.

**G6056** GAS BOTTLE BASE HOLDER



**G6056**

## TRUMA GAS REMOTE SWITCH

**Convenient way of switching off the gas system when it is not in use.**

If the gas system is not being used, the gas cylinder valves should always be closed. The Truma remote gas switch is the ideal solution to the problem, particularly for cylinder boxes in caravans and motor homes that are difficult to access. Shuts-off entire gas supply from the interior by the push of a button, readiness for operation indicated by an LED on the control panel. 40 mA power consumption when valve open (no power consumption when closed). Connections 8mm male stem inlet & 8mm olive and nut outlet. Electro valve is completely sealed for safe installation in gas locker.

**GVTESO** TRUMA 12V ELECTRO SHUT OFF ISOLATION VALVE FOR GAS SYSTEM



**GVTESO**



**GPTADBUTPRO** Easy fit Adaptor to convert 21.8LH butane hoses to fit POL propane cylinders



**GADPOLBC** Propane blanking cap allows use of manual or auto changeover with only one cylinder fitted.



**GADPOL** Remote appliance adaptor screws into W20 end of pigtail allowing cylinder to stay in locker and run a remote barbeque with its own standard propane regulator.



**GAD20HEX** Hose Extender 21.8LH Male to W20 Male adaptor. Use to join together another butane pigtail to extend. Ideal for German vans with bottle mounted regulators to reach a remote small cylinder



**GAD218ELB** Fits directly on outlet of a Gaslow cylinder preventing dangerous over-stressing and kinking of Stainless Steel pigtails in restricted areas. It also fits all the Butane pigtails & adaptors. (See Page 60)



**GAD208H** W20 NUT X MALE 8MM HOSE BARB.



**GAD20FEM** W20 double female connector



**GAD20CAP** W20 FEMALE THREAD BLANK CAP



**GV20** INLINE W20 GAS TAP



**GAD20WASH** SPARE W20 WASHER FOR PIGTAILS (5p not included!)



**GAD20ELB** ELBOW W20 NUT & W20 THREAD

## BUTANE PROPANE ADAPTOR - GADPOLBUT

ADAPTOR TO CONVERT ANY BUTANE THREADED OR REFILLABLE BOTTLE TO USE YOUR EXISTING PROPANE PIGTAILS



## GASLOW 300 UNIVERSAL REGULATOR

**Regulator failure... There's no warning and the effects are devastating.**

Where can you find a replacement? It's almost impossible at short notice!...and then there's the cost!...and what stops it happening again? **We guarantee it won't happen!** Why take the risk? Replace it now and guarantee it won't happen to you. Then you can keep your replaced regulator in your locker... it may not have a warranty but it could help someone else when they have a problem!

The Gaslow 300 caravan regulator is a superior regulator which can work with both Butane and Propane gas. The system comprises a 30mbar wall mounted regulator with 750mm Stainless Steel Hose for Gaslow Refillables or butane cylinders and also a GPTADBUTPRO adaptor for Propane. Includes a guaranteed **FIVE YEAR WARRANTY**

**GREG1775** 30mbar Caravan Regulator System Kit - 8mm copper  
**GREG1770** 30mbar Clesse Caravan Regulator Only - 8mm copper



Replace it with a Gaslow 300 Universal Regulator



**GREG1770**



**GREG1775**

## RUBBER LINED PIPE CLIPS

**GPCLIP10** 10MM RUBBER LINED P CLIP  
**GPCLIP8** 8MM RUBBER LINED P CLIP  
**GPSADL810** 8 - 10MM RUBBER LINED SADDLE CLIP

## INLINE GAS QUICK CONNECTOR

**GQCSTR8** 8MM INLINE QUICK CONNECTOR  
**GQC�8** Quick connect 8mm hose nozzle see Page 61

## PTFE THREAD SEALING TAPE

**GPTFE** ROLL OF PTFE THREAD SEALING TAPE. 12mm WIDE x 0.075mm THICK



**GPTFE**



**GPCLIP**



**GQCSTR8**

**GQC�8**

WE NOW OFFER INSTALLATION, GAS SAFETY TEST AND REPAIR SERVICE BY [SupremeTech.co.uk](http://SupremeTech.co.uk)



## SANITATION CHEMICALS RANGE

To ensure the efficient operation of your mobile toilet system, it is necessary to use toilet additives. There are additives for the waste holding tank, for the flush water tank and there are maintenance products.

### FLUSHWATER ADDITIVES

Flush water tank additive keeps the water 'fresh', ensures a smoother, better flush and leaves a protective film in the toilet bowl.

**TLT079** THETFORD AQUA RINSE 1.5 L PINK

**TLDEC15P** DOMETIC EXTRACARE PINK 1.5 LTR LIQUID

### TOILET WASTE HOLDING TANK ADDITIVES

Waste holding tank additives reduce unpleasant odours and gas build-up, break down waste matter and prevent clogging. They also prevent deposits from sticking to the inside of waste tanks. Toilet additives are necessary to make mobile sanitation systems work trouble free.

**TLT072** THETFORD AQUAKEM GREEN 1.5 LTR LIQUID

**TLT073** THETFORD AQUAKEM BLUE 1 LTR LIQUID

**TLT074** THETFORD AQUAKEM BLUE 2 LTR LIQUID

**TLT080** THETFORD AQUAKEM BLUE SACHETS 1 TUB OF 15 SACHETS

**TLT085** THETFORD AQUAKEM GREEN SACHETS 1 TUB OF 10 SACHETS

**TLDPC TAB** DOMETIC POWERCARE TABS 16 1 DOSE TABLETS

### TOILET ROLL

Specially formulated toilet tissue to break down quickly in the holding tank. Use of domestic multi layer tissue will clog your toilet mechanism as it takes a considerable time to dissolve and break down.

**TLT070** THETFORD AQUA SOFT PACK OF 4 ROLLS

### GREY WASTE TANK FRESHNER

Thetford Tank Freshener is an effective additive for the grey water tank. The grey water tank holds shower, washbasin and kitchen wastewater. After a while deposits build up in the grey water tank resulting in unpleasant smells. To combat this, Thetford Tank Freshener can simply be added directly into sink or shower drain, guaranteeing a fresh and clean grey water tank. Pleasantly pine-scented.

**TLTFR15** THETFORD TANK FRESHENER FOR GREY WASTE TANKS 1.5 L bottle

### MAINTENANCE PRODUCTS

**TLSLUB** THETFORD SEAL LUBRICANT 200-ml aerosol (C)

Thetford seal lubricant specially developed for lubricating door and toilet seals, locks, hinges, awning rails, bicycles, etc. It also ensures a smooth operation of your toilet valve blade. 200-ml aerosol

**TLPLSY** THETFORD BATHROOM CLEANER PLASTIC SPRAY (F)

Thetford plastic cleaner is active foam for easy, safe and thorough cleaning of all plastic surfaces in caravans and motorhomes. The active foam removes hard water stains and ensures perfect hygiene and a brilliant shine. 500-ml trigger spray.

**TLCBCL** THETFORD TOILET BOWL CLEANER 750ml

A plastic and ceramic safe cleaning agent for the toilet bowl of mobile toilets that will not destroy the seals like bleach based cleaners. Unique descaling qualities, easily removes soil & scale deposits, prevents growth of soil leaving a beautiful shine & brilliance. Thick concentrated formula coats the bowl for better cleaning, targets hard to reach areas of the bowl, leaving a fresh scent.

**TLCBTC** THETFORD CASSETTE BASE TANK CLEANER

A cassette tank cleaner will clean and maintain the waste tank of your cassette or portable toilet, removing organic & inorganic scale from tank and mechanism.

### SOG SYSTEM – Chemical free operation of your toilet system

The SOG toilet ventilation kit converts your Thetford toilet into a chemical-free system which is not only a completely green solution but also banishes smells from the interior of your unit. No chemical smells and no smells from waste matter, even during use of the toilet. Toilet chemicals are no longer necessary and optimal decomposition is guaranteed by the increased flow of Oxygen. You can also use ordinary toilet paper. Supplied as a very simple diy-fit kit.

**SOGDALL** For C400's with or without fluid store under cassette



C 400



C 250

**SOGF** for toilets C250/C260



**SOGA** for toilets C2 C3 C4



**SOGB** for toilets C200



**SOG3000A** for Dometic CT 3000



**SOGPERM** for PERMANENT FIXED HOLDING TANKS



TLTFR15

TLSLUB

TLPLSY

TLCBCL

TLBCTC



### CAKTSC100 NEW TANKKLEEN FRESH TANK CLEANER STERILISER.

Tankkleen is the only product we recommend for cleaning C.A.K. Tanks and water systems. It is very safe and leaves no after taste as it is used also for cleaning winemaking equipment. Do not be tempted to use chlorine based cleaners as they will attack piping and other plastics leaving a nasty medical taste.



### Blue Bio

Blue BIO is a new generation portable toilet fluid that works through NATURAL BIOLOGICAL ACTIVITY (enzymes). As a result, it's safe to use and harmless to humans, pets and wildlife. 2in1 – Toilet, Waste & Flush Tank Additive. Up to 50 doses in a 1 Litre bottle! Up to 33 doses if used in both the waste & flush tank. Blue BIO enzyme bacteria work with the natural bacteria present in sewage to accelerate the NATURAL breakdown /degradation of waste

**TLTBIO**

BLUE BIO 1 LITRE BOTTLE



TLDPC TAB



TLTBIO

**SOGG** for New Thetford C500 toilets

WE NOW OFFER INSTALLATION SERVICE IN KENILWORTH BY [SupremeTech.co.uk](http://SupremeTech.co.uk)



## ACCESSORIES FOR AQUA MAGIC, MKIV, MKV STARLITE, ELECTRA MAGIC & BRAVURA

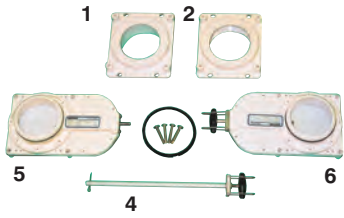

- 1 **1659** BOND ON ADAPTOR TANK TO EZ-VALVE
- 2 **1959** THREAD ON ADAPTOR EZ-VALVE
- 4 **4100** EXTENSION HANDLE 10" FOR 08707
- 5 **8707** 2X SLIDE EZ-VALVE REQUIRES 4100
- 6 **8706** 2H SLIDE EZ VALVE STANDARD VALVE
- 8737** SLIDE VALVE TO ADAPTOR SCREWS
- 1457** ADAPTOR SEAL BOND ON SLIDE VALVE

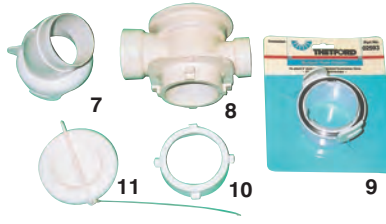

- 7 **1665** CURVED HOSE BAYONET ADAPTER
- 8 **1952** DOUBLE ENTRY COLLECTOR
- 9 **2593** BUMPER HOSE BAYONET ADAPTER
- 10 **1639** BAYONET RING
- 11 **1664** BAYONET CAP
- H7S** 3" FLEXI DISCHARGE HOSE / MTR (See P24)
- H7FL** 3" LAYFLAT DISCHARGE HOSE / MTR (See P20)

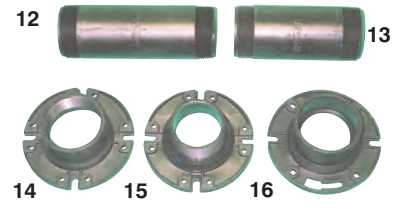

- 12 **8648** MALE THREADED 3" PIPE 10"
- 13 **8529** MALE THREADED 3" PIPE 8"
- 14 **2621** CLOSET FLOOR FLANGE FEMALE THREAD
- 15 **2620** CLOSET FLOOR FLANGE MALE THREAD
- 16 **7580** CLOSET FLOOR FLANGE PLAIN (NPT)
- HC7** 3" HOSE CLIP FOR H7S DISCHARGE HOSE (See P24)

### AQUA MAGIC V

The NEW Aqua Magic V is a modern, economical model that is easy to install and is operated by one two stage lever at the top of the toilet. This toilet can be supplied in two heights. In the case of the high model the waste tank is installed under the floor, and with the low model it is installed above the floor when used in boats.

#### Features:

- \* Finish: white
- \* Hook-up to vehicles central water tank: yes
- \* Hand operated by a 2 stage lever
- \* Better flush - full bowl coverage
- \* Waste tank capacity: dependent upon vehicle
- \* Flush water tank capacity: dependent upon vehicle
- \* Depth 455mm x Width 383mm x Height 5L 329mm, 5H 445mm

- TLTAM5L** Aqua magic V low hand lever operated white
- TLTAM5H** Aqua magic V high hand lever operated white

### BRAVURA

The Bravura is a floor mounted, fresh water-flush toilet. Flush water for the Bravura is drawn from an independent pressurised water supply. Waste is released into a permanent holding tank, which is installed below the floor, and is drained off outside the caravan or motorhome with the slide valve. Low model suitable for boats with above floor holding tank.

#### Features:

- \* Finish: white
- \* Hook-up to vehicles central water tank: yes
- \* Convenient single-foot-pedal operation
- \* Powerful pulsating flush with full bowl coverage
- \* Comfortable seat and height
- \* Deep bowl so less splashing
- \* Stylish design and smooth surface allowing easy cleaning
- \* Easy installation and access of parts
- \* Available in high and low profiles

- TLTAMBL** Aqua magic Bravura low pedal operated white
- TLTAMBH** Aqua magic Bravura high pedal operated white

### ELECTRA MAGIC

This is a recirculating toilet suitable for buses and touring units. A silent toilet that never gets blocked. This model does not require a separate waste holding tank nor a connection to a water supply line. The toilet is charged with clean water and toilet additive. The pump recycles the fluid and solids are collected by a double filter system. The double filter system takes away any risk of obstruction. An easy to read level indicator signals the initial charge level and warns when the waste tank is almost full. A valve underneath the toilet is opened to evacuate the waste into a holding tank, and the process starts again. The tank is then emptied at an authorised disposal point. Toilet can be operated on its own capacity without a holding tank is the installation need require this.

#### Features:

- \* Finish: parchment
- \* Flush: electric (12 or 24 Volt versions)
- \* Initial charge volume (fresh water + toilet additive): 9,2 L
- \* Waste capacity: 14,3L
- \* Total unit capacity: 23,5L

- TLTEMAG12** Electra magic recirculating 12 v
- TLTEMAG24** Electra magic recirculating 24 v

### PERMANENT TOILET DISCHARGE HOLDING TANKS

Toilet discharge holding tanks are available from our vast range of standard sizes. See tank illustrations at beginning of catalogue. A simple installation scheme drawing is published here, see right. Technical and system design advice available. Full range of Thetford spares and accessories supported.

**WE ARE THETFORD'S PREMIER SPARES & SERVICE CENTRE. WE ARE ABLE TO SUPPLY ANY THETFORD SPARE PART THAT IS CURRENTLY AVAILABLE & QUITE A RANGE OF OBSOLETE PARTS. WE HAVE THE FACILITIES TO INSTALL SERVICE AND REPAIR THE FULL THETFORD PRODUCT RANGE.**



**MKV HIGH**      **MKV LOW**

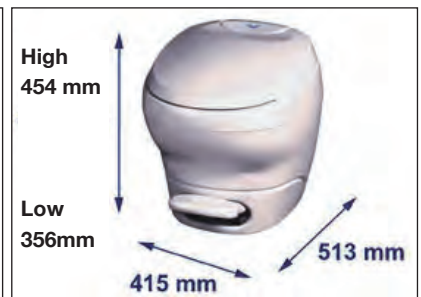

**BRAVURA**

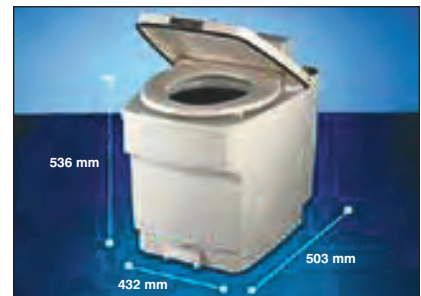

**ELECTRA MAGIC**

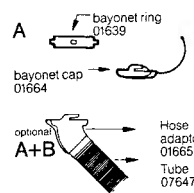
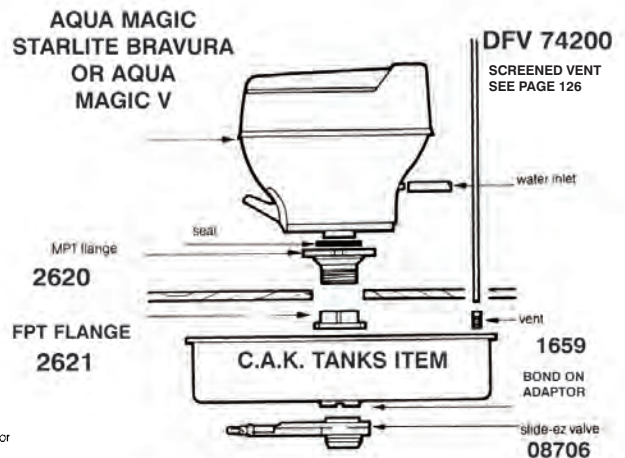

WE NOW OFFER INSTALLATION SERVICE IN KENILWORTH BY [SupremeTech.co.uk](http://SupremeTech.co.uk)





## NEW PORTA POTTI EXCELLENCE

The Porta Potti Excellence has by far the most striking design and innovative features of all. The Porta Potti excellence has a Modern design, more homelike toilet shape with a Comfortable seating height (440 mm), Bigger bowl size, mainly in depth and width, User friendly valve handle at side, Integrated toilet paper holder, Flush-water & waste water level indicators, Cover controls (for piston pump, water fill cap, water level indication), Water fill adaptor and Improved carry handle of the water tank. White, Ivory and Ruby red with manual piston pump or Granite with battery operated electric pump (six 1.5v AA batteries enough for 500 to 700 flushes)

Waste tank capacity 21L, flush water capacity 15L, Seating height 443mm, height 458 x width 388mm x depth 450mm

- TLPEXMW PORTA POTTI EXCELLENCE MANUAL WHITE
- TLPEXMY PORTA POTTI EXCELLENCE MANUAL IVORY
- TLPEXMR PORTA POTTI EXCELLENCE MANUAL RUBY
- TLPEXEG PORTA POTTI EXCELLENCE ELECTRIC GRANITE
- TLPEXMP FLOOR MOUNTING PLATE FOR PP EXCELLENCE

## NEW PORTA POTTI QUBE

Porta Potti Qube forms the basis for our new generation of durable portable toilets. We guarantee all the quality you have become accustomed to, transformed into a new and fresh design. The smooth lines and subtle curves are not just important towards the appearance of our toilets; they also provide optimum comfort and ease of use. The toilets are equipped with an integrated cover lock, a recess for opening the cover, an improved blade opener as well as a more comfortable handle on the waste-holding tank. The stopper on the waste-holding tank holds the emptying spout in position, making it easier to mount one tank on top of the other. Our Porta Potti's come with a three year warranty. HOLD DOWN BRACKET INCLUDED WITH PPQ335 OPTIONAL KIT AVAILABLE for PPQ365.

All Thetford Porta Potti and Cassette toilets have the unique swivelling pour out spout system and pressure release button for splash free emptying.

## CASSETTE C-200 SWIVEL BOWL

The elegant, domestic bathroom style bowl of the Thetford Cassette C-200 can be swivelled through 180 degrees on its pedestal locking securely at any stage the user chooses. So the toilet can be fitted freestanding against any single wall in the vehicle bathroom area. And the bowl can be swivelled away after use to liberate space. A LED signal that lights automatically when the holding tank is nearly full, and a contoured shape that shrugs off shower water are amongst other unique features. **C200CS** uses water directly from the fresh cold water supply system in the vehicle. Suitable for pressurised and micro switched water systems. **C200CW** uses water manually pumped from its built in fresh water tank within toilet. Toilet requires a waterfill door installed on outside in addition to door used for cassette base tank removal. **C200CWE** has similar features to the C200CW with the addition of touch button electric flush.

## THETFORD C200 TOILET BOXED INSTALLATION KITS INC DOOR

- TLTC200CS CASSETTE C200CS DIRECT ELECTRIC WHITE + DOOR 3
- TLTC200CW CASSETTE C200CW MANUAL WHITE + WATERFILL & DOOR 3
- TLTC200CWE CASSETTE C200CWE ELECTRIC WHITE + WATERFILL & DOOR 3
- THETFORD C200 TOILET & WASTE CASSETTE ONLY NO DOOR OR ACCESSORIES
- TLTC200CSND CASSETTE C200CS DIRECT ELECTRIC WHITE NO DOOR
- TLTC200CWND CASSETTE C200CW MANUAL WHITE NO DOOR
- TLTC200CWEND CASSETTE C200CWE ELECTRIC WHITE NO DOOR
- 23786 Optional outside vent kit for C200.

## SPARE CASSETTE BASE TANKS

All our base tanks are new original products from Thetford. They will come correctly handed as per your ordered hand. You will not need to modify or dismantle them; they will glide straight in ready for use. To identify the handing of your required base tank, it is handed by describing the end of the toilet where the door is to remove the cassette. **This handing is described as seated on the toilet NOT AS LOOKING AT IT.** This does not apply to the C200 & C250 swivel bowl units as their base tanks only slide in one way. You can identify which model toilet you have by locating the silver and blue Thetford serial number label just inside the door end of the toilet.

## C200 SWIVEL BOWL

Spare base tank for C200 series swivel bowl all models. Picture A.

- TLTC200BTANK C200 base tank complete

## C250 / C260 SWIVEL BOWL

Spare base tank for New C250/C260 series swivel bowl all models. This model base tank is complete with wheels.

- TLTC250BTNK C250 base tank complete (Wheeled model). Picture B.

## C2, C3, C4 FIXED BOWL OLDER BENCH MODEL

This is the base tank for the older model bench toilet. Handing is identified as seated on the toilet.

- TLTC234BTNKL C2, C3, C4 LEFT HAND BASE TANK. Picture D
- TLTC234BTNKR C2, C3, C4 RIGHT HAND BASE TANK. Picture D



PORTA POTTI SPECIFICATIONS					
	145	165	335	345	365
STOCK CODE WHITE	NO	NO	PPQ335W	TLPPQ345W	TLPPQ365W
STOCK CODE GREY	TLPPQ145G	TLPPQ165G	NO	NO	NO
FLUSH	BELLOW	BELLOW	PISTON PUMP	PISTON PUMP	PISTON PUMP
WASTE TANK CAPACITY	12	21	10	12	21
WASTE LEVEL INDICATOR	NO	NO	YES	YES	YES
FLUSH WATER CAPACITY	15	15	10	15	15
FLUSH WATER LEVEL INDICATOR	NO	NO	NO	NO	NO
SEATING HEIGHT	324	408	308	324	408
HEIGHT	330	414	315	330	414
WIDTH	383	383	342	383	383
DEPTH	427	427	382	427	427

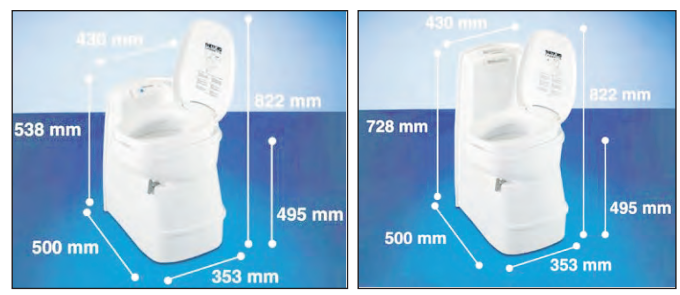

CASSETTE C200 CS      CASSETTE C200 CW, CWE

C200 CASSETTE SPECIFICATIONS			
MODEL	C200CW	C200CWE	C200CS
FLUSH	MANUAL	ELECTRIC	ELECTRIC
WASTE TANK CAPACITY	17LTR	17LTR	17LTR
FRESH WATER CAPACITY	7LTR	7LTR	DIRECT FLUSH
COLOUR	WHITE	WHITE	WHITE

## NEW C500 BASE TANKS PICTURE E

- TLTC500BTKR C500 BASE TANK RIGHT HAND
- TLTC500BTKL C500 BASE TANK LEFT HAND

FOR C400 BASE TANKS SEE NEXT PAGE

WE ARE THETFORD'S PREMIER SPARES CENTRE. WE ARE ABLE TO SUPPLY ANY THETFORD SPARE PART THAT IS CURRENTLY AVAILABLE & QUITE A RANGE OF OBSOLETE PARTS.

WE NOW OFFER INSTALLATION SERVICE IN KENILWORTH BY [SupremeTech.co.uk](http://SupremeTech.co.uk)

## CASSETTE C400 RANGE

New elegantly designed bench model toilet for caravans and motorhomes. The award winning C400 range are elegantly designed toilets to match modern bathrooms.

Packed with innovative features such as the holding tank with wheels and a retractable carrying handle. Not as an option but standard on all C400 models. Stable thermoplastic rubber treaded wheels allow easy and reliable transport of the waste holding tank. Toilet waste holding tank transport with an ease never experienced before. The removable mechanism plate allows easy access to the waste holding tank inner for cleaning or service, a major feature of the C-400. No more fumbling in the dark! Comfortable seating position higher and deeper than models before, allowing for more comfort when in use. Plus more space for the feet due to the recessed base. Really practical in an often confined vehicle bathroom. The flowing curved shape allowing easy cleaning, leaving no dirt traps.

### C400 Range Key Features

- Finish: white (RAL 9003)
- Electric touch button flush (12V)
- Waste holding tank with integrated wheels
- Waste tank with handy extendable carry / pull handle
- Removable plate allows access to waste tank interior for easy cleaning and service
- Integrated pour-out-spout: no handling of separate parts that get dirty
- Waste tank vent button allowing splash free emptying
- Weight: 8,5 kg

### Cassette C402C

The starter model in the range, the Cassette C402C toilet has an integrated freshwater tank, powerful touch button electric flush and single led high level indicator for waste holding tank only. Easy waste transport: holding tank on wheels! **Optional external vent.**

#### Features:

- LED display indicates fill level of waste tank
- Waste tank capacity: 19,3L
- Integral freshwater tank capacity: 15L

**TLTC402CL CASSETTE C402C LEFT HAND & DOOR 3**

**TLTC402CR CASSETTE C402C RIGHT HAND & DOOR 3**

### Cassette C402X

The Cassette C402X toilet has an integrated freshwater tank, powerful touch button electric flush and led level indicators for waste holding tank and flushwater tank. Easy waste transport: holding tank on wheels! A quick touch the flush button and the LED level indicator system displays how much capacity is still available in both flushwater tank and waste tank. **Optional external vent. This is our most popular C400.**

#### Features:

- LED display indicates fill level of waste tank and flush water tank in 3 steps
- Waste tank capacity: 19,3L
- Integral freshwater tank capacity: 15L

**TLTC402XLD3 CASSETTE C402X LEFT HAND & DOOR 3**

**TLTC402XRD3 CASSETTE C402X RIGHT HAND & DOOR 3**

### Cassette C403L

The Cassette C403L toilet hooks up to the central water tank of the vehicle. Touch button electric flush. Easy waste transport: holding tank on wheels! A quick touch the flush button and the LED level indicator system displays how much capacity is still available in the waste holding tank. **External venting of waste tank standard.**

#### Features:

- LED display indicates fill level of waste tank 3 steps
- Waste tank capacity: 19,3L
- No integrated freshwater tank. Toilet connected to central water system of caravan or motorhome. Direct flush.

**TLTC403LLD3 CASSETTE C403L LEFT HAND & DOOR 3**

**TLTC403LRD3 CASSETTE C403L RIGHT HAND & DOOR 3**

### SPARE BASE TANKS & ACCESSORIES

This is the base tank for the newer model C400 bench toilet as described above. Handling is identified as seated on the toilet.

**TLTC400BTANKL C400 LEFT HAND BASE TANK**

(Wheeled model)

**TLTC400BTANKR C400 RIGHT HAND BASE TANK**

(Wheeled model)

**TLTC400VENT C400 THRU FLOOR OUTSIDE VENT**

**WE CAN SUPPLY ANY THETFORD SPARE PART THAT IS AVAILABLE**

### CONTESSA C400 TIP UP BASIN AND SHOWER TRAY

The new tip up designed specially for installation above and behind the C400 range. The standard Contessa Cabinet (VCTCABW) mounts above the Contessa C400 Tip Up (VCTIP400W) in the usual way. See Page 68. C400 universal shower tray see page 69.

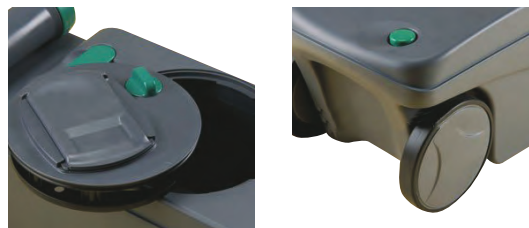

**SPARE BASE TANKS AVAILABLE**



WE NOW OFFER INSTALLATION SERVICE BY [SupremeTech.co.uk](http://SupremeTech.co.uk)

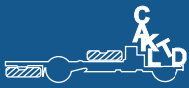

# THETFORD & DOMETIC CASSETTES & SOG SYSTEM



## NEW THETFORD CASSETTE C260

The C260 Cassette Toilet is a 'facelift' the C250 Cassette Toilet. With its 2 x 90 degree revolving toilet bowl, the C-260 has several exciting new, improved features and a contemporary design. A more stable seat & cover, easier to clean bowl design and an improved flush are some examples. This toilet is also available with a full ceramic bowl for a true home-like sanitary experience. Enhanced seating comfort: the toilet bowl width and depth have been adjusted to provide maximum comfort. • A waste-holding tank (17.5L) on wheels with a pull-out handle. • A user-friendly control panel.

C262CWE with integrated 8 L flush water tank. Packed Complete with Thetford Door 3 and accessories in kit.



THETFORD C260 RANGE

- TLTC263CS** C263CS DRAWS FLUSH WATER FROM ONBOARD PUMPED WATER SYSTEM
- TLTC262CWE** C262CWE ELECTRIC FLUSH FROM INTEGRATED FLUSH WATER
- TLTC263CSC** C263CS CERAMIC BOWL DRAWS FLUSH WATER FROM ONBOARD PUMPED WATER SYSTEM
- TLTC262CWEC** C262CWE CERAMIC BOWL ELECTRIC FLUSH FROM INTEGRATED FLUSH WATER

**BUT THERE'S MORE... THE C-250/C-260 CAN BE UPGRADED WITH VARIOUS OPTIONS (SEE RIGHT) AT ANY TIME**

## DOMETIC CT4000 CASSETTE

CT 4000 series with ceramic inlay  
New toilet bowl design with scratch resistant ceramic inlay, stain-repellent and easy to clean. Comfortable and aesthetically pleasing, Innovative space-saving seat concept: 8 cm less depth than comparable products. The seat can also be adjusted [in 15° steps] up to 90° in both directions. More room in the bathroom. This gives more flexibility in confined spaces. Cassette tank [19 L] with telescopic handle and large, easy-running wheels for convenient transport to the disposal area. Pivoting spout facilitates tank discharge. Control panel with level indicator light warns you in good time before the tank level reaches the maximum level. Visual warning signal when the tank has been removed



CT3000 series

For vehicles without water supply the CTW 4110 toilet is supplied with an integrated flush water tank. The tank has a capacity of 7 litres and is easy to fill. Low in weight Weighs up to 30 % less than a ceramic toilet. Dometic SK5 locker door supplied as standard with each CT 4000-series toilet. Dimensions [ W x H x D ] 382 x 672 x 500 mm . Waste tank capacity 19 litres. 12v DC.

- DCTS4110** CTS is designed for connection to onboard pumped water system.
- DCTW4110** CTW has integrated 7 litre flush water tank with pump
- DCT3110SBT** SPARE CASSETTE BASE TANK for CT3000 / CT4000

### CT 3000 series: prepared for SOG exhaust system

Unpleasant odours can easily become a problem in the small sanitary cabin of a campervan. This problem is efficiently solved with the SOG toilet ventilation system. It provides cleaner, fresher air by exhausting odorous gases to the outside via flexible tubing. Both CT 3000 models are prepared for installation of the SOG system so that it can be retrofitted with ease.

## FRESH UP KITS AVAILABLE FOR C234, C200 & C400. Includes new base tank, new seat and cover and chemicals.



- TLTC234FRESHUP** For Older C2,3,4 bench model (base tank D page 65)
- TLTC200FRESHUP** For C200 swivel bowl model (base tank A page 65)
- TLTC250FRESHUP** For C250 swivel bowl model (base tank B page 65)
- TLTC400FRESHUP** For C400 new bench model (base tank E page 65)

## C250 OPTIONAL UPGRADE KITS



**TLTC250AFV** Automatic fan vent upgrade



**TLTC250CBFILT** Spare carbon filter for C250AFV

## C260 OPTIONAL UPGRADE KITS



**TLTC260AFV** Automatic fan vent upgrade



**TLTC260CBFILT** Spare carbon filter for C260AFV



DTT972G

DPP976G

### Dometic 970 series portables

Small, but a big performer: handy and spacesaving, the 970 series adds hygienic comfort to your recreational vehicle. Many sensible functions are contained in the smallest possible space to ensure you can enjoy home-like comfort when travelling.

Portable toilet in two sizes and two colours  
Push-button control for powerful flushing with less pumping Extra-strong 360° pressure flush for effective cleaning. 8.7-litre flush water tank – sufficient for 27 flushes. Safety through overflow protection and tank level indicator. Ingenious disposal system: extra-long, pivoting spout and vent openings for clean, splash-free discharge. 972 - 333W x 317H x 387D 9.8 Ltr waste tank. 976 - 333W x 387H x 387D 18.9 Ltr waste tank.  
**DPT972G** 972 WHITE/GREY  
**DPT976G** 976 WHITE/GREY

**DOMETIC 966 TOILET**  
Full size seat & lid for comfort & support. Sturdy construction-one piece tanks won't leak. Bellows flush 9.8 ltr fresh water capacity. 19 ltr holding tank capacity. Size 394H x 368W x 419D  
**DPT966**



DPT966

Spare SOG parts and additional connectors available from our stock contact us for further information  
WE NOW OFFER INSTALLATION SERVICE BY [SupremeTech.co.uk](http://SupremeTech.co.uk)



0844 414 2324



0844 414 2425



**VCT400TIPW Contessa 400 tip-up**  
**NEW CONTESSA C400 TIP-UP** is designed to fit directly behind the new Thetford C400 Cassette toilet range. Shaped to match the flowing contours of this elegant new toilet. Tip up accommodates WRT2500 Combo tap & shower. Requires 1 1/4" waste fitting (SW180). The existing Contessa cabinet fits directly on top.



**VCTCABW Contessa cabinet**  
 Cabinet has two sliding mirror doors and fits directly to top of Contessa tip-up. Sizes Tip-up (870 H X 670 W X 150 D), Cabinet (530 H X 670 W X 130 D)



**VSIMTIPW TIP UP**  
 Simple small wall mounted tip up. Size 350H closed x 502W x 160D closed (310mm open) Requires special size waste SW18030 for 1/2" hose.



**VC4TTIPW COMPACT TIP-UP**  
 Tip up requires 3/4" waste fitting (SW18075). Size 665 H X 515 W X 145 D closed + handle 25mm (420mm open)



**VC4TCABW COMPACT CABINET**  
 Cabinet has hinged door with mirror. Designed for simple screw fixing to bathroom wall. Size 540 H X 520 W X 120 D + handle 40mm



**RECTANGULAR BOWL**  
 VRB3928W Rectangular basin 390mm x 280mm white (use SW18075)



**SMALL CORNER BOWL**  
 VCB285W Small corner bowl 285mm X 285mm white (use SW18075)



**VOV5336W Oval inset bowl white**  
 (535mm W X 360 mm D) Use 1 1/4" waste (SW180)



**VST1367W 1130 mm x 670mm**  
 Extra large shower tray white. With 2 waste positions (Use 1 1/4" waste fitting SW180) Length can be reduced to 1090mm by trimming 20mm off either end.



**VRB5529W Rectangular basin**  
 designed to fix into top surface of vanity unit, this stylish basin has rolled edges with moulded free draining soap dish. White. 555mm x 285mm x 110mm deep bowl. Use 1 1/4" waste fitting (SW180)



**NEW VST2APRW Corner cut C200**  
 RH tray 1050 x 750mm. Use 1 1/4" waste fitting (SW180)



**VST585W 585 x 585mm x 95mm high**  
 Small shower tray white. (Use SW180 waste fitting).



**VCB390W Corner bowl white**  
 390 mm X 390 mm (Use SW180 waste fitting)



**NEW VCB368W Corner bowl white**  
 368 mm X 368 mm (Use SW180 waste fitting) Matches



**NEW VCPED368W Matching pedestal**  
 for VCB368W 915mm high.

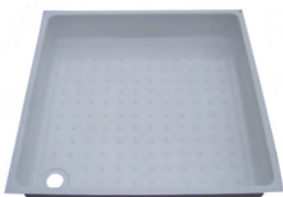

**NEW VST670W 670 X 670mm X 115mm high**  
 Shower tray white. (Use SW180 waste fitting)

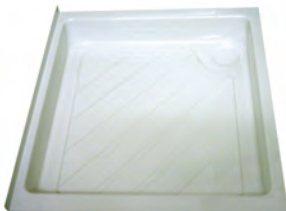

**NEW VST6848W 680 x 590 x 80mm high**  
 Shower tray white (Use SW180 waste fitting) Raised lip on one 680 side



**NEW VSTHETW Thetford recess**  
 to install swivel toilet. 680 x 600mm. Lowered lip on one 680 side



**VST580DPW 580 x 580mm x 120mm high**  
 Small deep shower tray white. (Use SW180 waste fitting).

WE NOW OFFER INSTALLATION & REPAIR SERVICE BY [SupremeTech.co.uk](http://SupremeTech.co.uk)



**VBSCPTPW** Basic wall mounted tip up with integrated storage compartment above tip up basin. Size Height 655mm x Width 505mm x Depth Open 315mm, Closed 160mm. Requires special size sink waste SW18030



### SOFT SHOWER MAT

The shower mats are a soft non slip anti mildew polyurethane. With an aerated design so will drain properly. Size 55cm x 55cm. Colour and pattern may vary.  
**VSTMATG** SOFT SHOWER MATT GREY  
**VSTMATB** SOFT SHOWER MATT BEIGE

### C200 SHOWER TRAY

Shower tray specially designed for Thetford C200 toilet installations. Two trays are available for left hand or right hand fit. Cut outs are profiled to match the toilet sealing rim while allowing a cleaning gap to the rear side of the C200 console. Tray has two positions, W on photo, for waste outlet (SW180) and length can be shortened to 1075mm max. Colour: white.

- VST200RW** C200 shower tray RH position white
- VST200LW** C200 shower tray LH position white
- VST20090** C200 shower tray 90 deg position

### UNIVERSAL SHOWER TRAY TRIM TO REQUIRED SIZE

The universal shower tray is designed to be easily adaptable to fit almost any situation. There is plenty of plastic to allow trimming to any size or shape of shower room. We have modified the tooling so the 7 grip bar detail has change to rows of buttons to match the base of the tray and aid cutting to size in this portion. (Requires SW180)

- VSTUNT1W** Universal shower tray white

### NEW C400 UNIVERSAL SHOWER TRAY

The NEW C400 universal tray has been designed to locate directly into the front lip of the C400 moulding. Tray has two positions, W on photo, for waste outlet (SW180) and length can be shortened to 780mm max.

- VSTUNT400W** C400 Universal shower tray white

### MOULDED SHOWER MATS & AWNING DECKING

Tough and flexible moulded shower mats, keep shower trays scratch free, easy on your feet, no need to remove for showering, anti-slip surface, cleaner and simpler than carpet mats getting damp. Can also be used under awnings to make an easily moveable entrance path or decking on damp grass or muddy surfaces. Keeps your living area cleaner. Colour: white.

- VSM50W** Shower mat/ decking 500mm square 25mm thick

### SINK WASTES FOR KITCHEN & BATHROOM EQUIPMENT

Sink wastes for shower trays, sinks & bowls. Generally a straight waste is used on shower trays to project directly through the floor. For sinks and bowls it depends on the installation whether a straight or angled waste will be suitable.

- SW9075** 3/4" white top angled sink waste for 3/4" hose
- SW18075** 3/4" white top straight sink waste for 3/4" hose
- SWP075** 7/8" spare plug for 3/4" sink waste
- SW90** 1 1/4" s/s top angled sink waste for 3/4" hose
- SW180** 1 1/4" s/s top straight sink waste for 3/4" hose
- SWP125** 1 1/2" spare plug for 1 1/4" sink waste
- SW18030** 3/4" waste for VSIMTIPW

New 1 1/4" waste for 28mm easy flow push fit waste system see page 26 in catalogue.

SMEV sinks and combination units require a special sink waste see page 39 in catalogue and corresponding price list page.

Sink waste smell traps see page 26.

### COMPACT BOAT & MOTORHOME BATH

Our original Motorhome and Boat bath allows sitting on the step seat. Its size makes it particularly suitable for Motorhomes, Caravans & Narrowboats. Bath can double up in use as a shower area. Colour available is white. Requires 1 1/4" waste fitting ( SW180 OR SW90 ). Maximum filling capacity; VBT1W: 180 LTR.

**VBT1W** MOTORHOME & BOAT BATH

WHITE

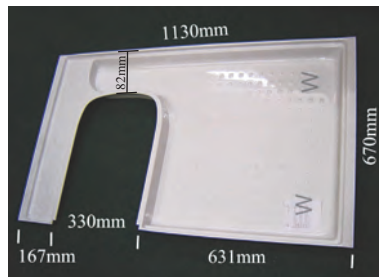
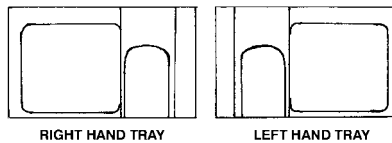

Depth 65 max

**C200 TRAY LEFT HAND**

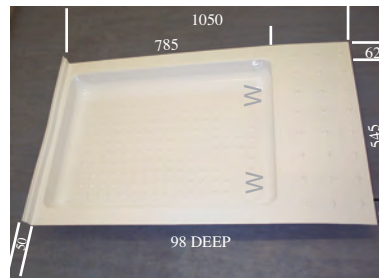
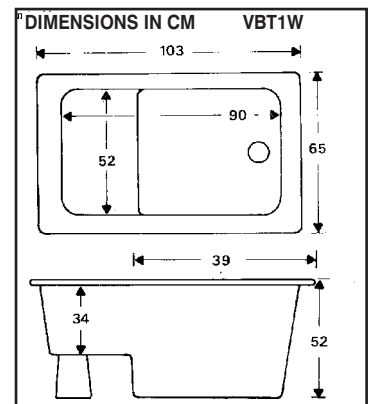

**VSTUNT400W**

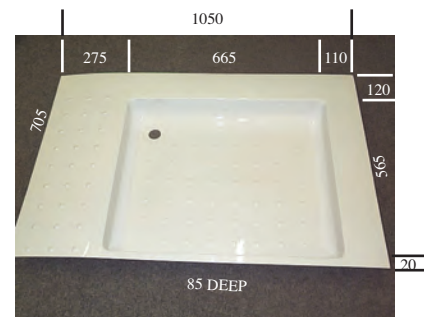

**VSTUNT1W**



**VSTUNT400W**



**SINK WASTES**

WE NOW OFFER INSTALLATION & REPAIR SERVICE BY [SupremeTech.co.uk](http://SupremeTech.co.uk)



0844 414 2324



0844 414 2425



# SEITZ HEKI ROOF VENTS



If you are fitting several vents to a vehicle not all will require permanent ventilation.

## SEITZ MIDI HEKI ROOFLIGHT

The **Seitz Midi Heki**, the 'big brother' to the successful Mini Heki Plus, (see page 65) has the same comfort features and exceptional quality but a larger aperture 700 x 500 mm. Ideal for owners of vehicles where Heki 2,3,4 models could not be installed due to size. Double-glazed, aerodynamically shaped light grey tinted acrylic dome, inner and outer pane glued together to aid easy cleaning. Opens in 3 positions: completely open, half open and bad weather position. The dome overlaps on the sides so no water can splash inside when the dome is in bad weather position. Handy operating lever for easy adjustment of the dome & is automatically locked when closed. Daylight clearance 585 x 404 mm for maximum light. Easy installation in roofs with a thickness of 25-60mm, Midi Heki comes standard with kit to fit into 30-34mm roof thickness. Weight only 7.6 kg. With Integrated fly screen and blind.

Also available are spacer kits to fit roof thicknesses; **SMDS1** 25-29mm, **SMDS2** 35- 42mm, **SMDS3** 43-52mm, **SMDS4** 53-60mm. Seitz Midi Heki is available with or without compulsory ventilation. Permanent Ventilation model = 15000 mm<sup>3</sup>. Crank or Electric versions available.

- SMDH3034 SEITZ MIDI HEKI FOR ROOF THICKNESS 30-34MM**
- SMDH3034V SEITZ MIDI HEKI FOR ROOF THICKNESS 30-34MM + PERM VENT**
- SMDH3034C CRANK MIDI HEKI FOR ROOF THICKNESS 30-34MM**
- SMDH3034VC CRANK MIDI HEKI FOR ROOF THICKNESS 30-34MM + PERM VENT**
- SMDH3034E ELECTRIC MIDI HEKI FOR ROOF THICKNESS 30-34MM**
- SMDH3034VE ELEC MIDI HEKI FOR ROOF THICKNESS 30-34MM + PERM VENT**

## SEITZ HEKI 2 ROOFLIGHT

The **Seitz Heki 2** rooflight was developed mainly for caravans. It can be installed on roof longitudinally or transversely. Double glazed acrylic panel is opened assisted by pneumatic stays for 3 ventilation options. Bad weather or night setting, the glazing panel is raised 12 mm approx. Locked in this position rain cannot penetrate into the caravan & the wind cannot lift the pane. Middle ventilation setting approx 150 mm held securely by locking the operating bar. Fully open, the panel is held open by pneumatic stays, approx 55°. Clear opening, 780 x 530mm, allows plenty of light in & good ventilation. When dome closed Permanent 13000 mm<sup>3</sup> Ventilation. Permissible maximum speed 100 km/h. With recommended spoiler 130 km/h Fits to flat surface only. Area for installation: 1080 x 790mm. Aperture 960mm x 655mm. Weight only 11 kg. Seitz Heki 2 comes supplied for roof thickness of 25 to 33 mm

- SH22533 SEITZ HEKI 2 FOR ROOF THICKNESS 25-33MM**
- SHSP810 810mm SPOILER**
- SHSP1110 1110mm SPOILER**

## SEITZ HEKI 2 DELUXE ROOFLIGHT

The highly successful Seitz Heki 2 for has been improved even further with the **Seitz Heki 2 Deluxe**. Subdued lighting and optimal thermal insulation provide comfortable cosiness. Integrated 4 x 5 Watt lighting. It uses the Innovative Duette Honeycomb material for greatest possible thermal insulation due to the hollow chamber construction. Blind and fly net mounted to the inner frame can be operated together or independently, by means of 2 fixing bars specially developed to match the colour of the inner frame. Installation dimensions as Heki 2.

- SH2DL2533 SEITZ HEKI 2 DE LUXE FOR ROOF THICKNESS 25-33MM**

## SEITZ HEKI 3 PLUS ROOFLIGHT

Enjoy more light and better ventilation with the **Seitz Heki 3 Plus**. Inner frame with seamlessly adjustable flynet and operated together with Duette honeycomb blind system ensures excellent thermal insulation, while built-in convenience lights (2 x 8 Watt) add subdued illumination. Seitz Heki 3 Plus is made from ASA. Safe and easy operation thanks to the winding mechanism. Acrylic double-glazed dome (tinted in grey) can be opened smoothly up for ventilation to 70° maximum when the vehicle is stationary, it can be raised up to 40 mm when raining. Robust locking system inside the outer frame for safety. Large overlap of glazing panel prevents water from penetrating when dome is raised. No permanent ventilation when dome closed. Clear opening: 790 x 510 mm, Surface area for installation: 1075 x 810 mm, Aperture 960mm x 655mm. For Longitudinal or transverse mounting. Weight only 15 kg. Seitz Heki 3 comes supplied for roof thickness of 27 to 33 mm

- SH32533 SEITZ HEKI 3 PLUS FOR ROOF THICKNESS 25-33MM**
- SH3CREX5360 CRANK EXTENSION FOR SEITZ HEKI 3**

## SEITZ HEKI 4 PLUS ROOFLIGHT

The **Seitz Heki 4 Plus** has all the features of the Heki 3 Plus with extra Deluxe features. Electric operation by remote control. Built in rain sensor so Heki 4 dome closes automatically if it rains. Clear opening: 745 x 533mm, Flat surface area for installation: 1080 x 790 mm Aperture 960mm x 655mm. Weight 15.5 kg. Comes supplied for roof thickness of 25-33 mm.

- SH42533 SEITZ HEKI 4 PLUS FOR ROOF THICKNESS 25-33MM.**

## SEITZ HEKI 2,3&4 SPACERS KITS

Spacer kits available to allow installation in roof thickness's up to 60 mm. **SHS1305 Black** 32-39mm, **SHS1306 Yellow** 39-46mm, **SHS1307 Blue** 46-53mm, **SHS1308 Red** 53-60mm.

## NEW SEITZ MIDI HEKI STYLE LENGTHWISE NARROW FIT

A new Slim roof light for motorhomes and caravans, perfect for lengthwise installation thanks to its size of 400 x 700 mm. Easy to use with crank (embedded into internal frame). The internal designer frame is equipped with black-out and fly-screen (separately and continuously adjustable). More light for slim dimensioned interiors, continuously variable opening positions up to 25 degrees. Slim roof opening with or without forced ventilation. Installation dimensions (mm) external space requirements 815 x 540, Cut out 700 x 400mm, Roof thickness from 25 to 60mm using optional midi heki spacer kits at top of page. Standard is 30- 34mm without use of spacers.

- SMDH7040STV MIDI HEKI STYLE VENTED**
- SMDH7040ST MIDI HEKI STYLE NON VENTED**



SEITZ MIDI HEKI STYLE

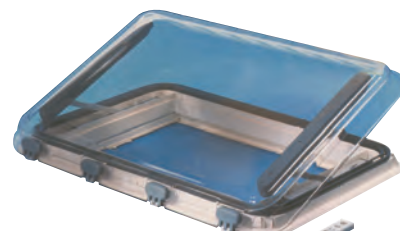

SEITZ HEKI 4 PLUS

WE NOW OFFER INSTALLATION AND REPAIR SERVICE BY [SupremeTech.co.uk](http://SupremeTech.co.uk)

Buy securely online at [Leisurelines.net](http://Leisurelines.net)

Ventilation



# ROOF VENTS



## INTEGRATED ROOF VENTS

Easily and securely fitted. Air gap insulated frame stops condensation. Free airflow to European spec even with roller blind closed. Telescopic stays, for easy and safe operation, opens on all sides. Five way push up with safety locking handles. Double skin dome for constant free airflow, spacers in between skins prevent deformation and restriction of airflow. Free airflow 290 model 5400mm<sup>3</sup> 420 / 47T model 15000mm<sup>3</sup>. 5-way push up dome is now available in Clear as well as opaque white. New Clear dome lets in 50% more light than the standard opaque white. All 290 & 420 come with internal beige frame 47T white inner frame. 280 x 280 mm & 400 x 400 mm cut out sizes are available. Roofvent inner and outer frames clamp together with No.6 - 3.5mm round or pan head **not countersunk** self tapping or chipboard screws. Screw length depends on roof thickness. Screws are not supplied.

- RFL2701VN** ROOFLIGHT 280 X 280 + LOCKS + FLYNET CLEAR DOME
- RFL2701VNR** ROOFLIGHT 280 X 280 + LOCKS + FLYNET + ROLLERBLIND CLEAR DOME
- RFL290N** ROOFLIGHT 280 X 280 C/W FLYNET OPAQUE DOME
- RFL290NR** ROOFLIGHT 280 X 280 C/W FLYNET + ROLLERBLIND OPAQUE DOME
- RFL420VN** ROOFLIGHT 400 SQ + LOCKS + FLYNET OPAQUE DOME
- RFL420VNR** ROOFLIGHT 400 SQ + LOCKS + NET + ROLLERBLIND OPAQUE DOME
- RFL47TVNW** ROOFLIGHT 400 SQ + LOCKS + FLYNET CLEAR DOME & PEARL WHITE INNER FRAME
- RFL47TVNRW** ROOFLIGHT 400 SQ + LOCKS + NET + ROLLERBLIND CLEAR DOME PEARL WHITE INNER FRAME

## NEW ROOF VENT WITH PLEATED DUO BLINDS

Easily and securely fitted. Air gap insulated frame stops condensation. Free airflow to European spec even with roller blind closed. Telescopic stays, for easy and safe operation, opens on all sides. Five way push up with safety locking handles. Double skin dome for constant free airflow, spacers in between skins prevent deformation and restriction of airflow. Free airflow 15000mm<sup>3</sup>. 5-way push up dome Clear dome lets in 50% more light than a standard opaque dome. White inner frame with pleated duo blind and fly net infinitely position able. Roof vent outer frame fixed with a series of clamp plates fixed with No.6 - 3.5mm round or pan head **not countersunk** self tapping or chipboard screws. Screws are not supplied. 400 x 400mm aperture cut out.

- RFL4701VNRW** ROOFLIGHT 400 X 400 + LOCKS + PLEATED DUO BLIND/ FLYNET CLEAR DOME

## NEW PLEATED DUO BLIND AND FLYNET FRAME AVAILABLE TO UPGRADE EXISTING 400X 400 ROOFLIGHTS.

If you have 400 x 400 roof vent with the older style hinged fly net and roller blind why not upgrade to the convenience of the new framed duo blind set. As long as your roof light has the grip handles with squeeze locks similar to those in the new vent pictured right you should be able to upgrade. If at all unsure, email us a picture of your vent for identification. Frame size 565mm x 530mm x 34mm deep. Upgrade only for MPK rooflights.

- RFL4RPLVNRW** UPGRADE KIT DUO BLIND / FLYNET FRAME AND CLAMP KIT

## SEITZ MINI HEKIPLUS ROOFLIGHT

The **Seitz Mini Hekiplus**, a bright idea for more light and fresh air. Suited exceptionally well for installation in standard-sized dome lights (400 x 400 mm), the Seitz Mini Hekiplus ensures a maximum incidence of light. Double-glazed, aerodynamically shaped glass dome made of unbreakable Polycarbonate and tinted light grey. Bonded together for easy cleaning. Opens in 3 positions: completely open, half open and bad weather position. With the glass extending on the sides and the outer frame standing up, no water can splash inside when the glass dome is in bad weather position.

Easy adjustment of the glass dome by using handy operating lever: the dome is automatically locked when closed.

Cut-out dimensions: 400 x 400 mm (standard dome light size) Clearance: 370 x 380 mm for maximum incidence of light Weight only 3.3 kg Easy installation in roofs with a thickness of 25 to 42mm. Special version for 43 to 60mm to order only.

Seitz Mini Heki is available with 15000mm<sup>3</sup> of compulsory ventilation or without. If you are fitting several vents to a vehicle not all will require permanent ventilation see Price list for further info.

- SMH2542** SEITZ MINI HEKIPLUS FOR ROOF THICKNESS 25-42MM
  - SMH2542V** SEITZ MINI HEKIPLUS FOR ROOF THICKNESS 25-42MM + PERM VENT
  - SMH4360** SEITZ MINI HEKIPLUS FOR ROOF THICKNESS 43-60MM
  - SMH4360V** SEITZ MINI HEKIPLUS FOR ROOF THICKNESS 43-60MM + PERM VENT
- Dimensions external 318 x 308 x H 74 mm. Internal 210mm diameter. Weight 2kg.

## SEITZ HEKI S

5 way push up version of the Mini Heki with single glazed dome.

- SMH2342VS** MINI HEKI S 23 - 42 ROOF THICKNESS VENTED
- SMH4360VS** MINI HEKI S 43 - 60 ROOF THICKNESS VENTED

## SEITZ HEKI AIR QUAD

Unique design of air flow guides provides increased levels of ventilation regardless of wind direction. 5 way push up mechanism fits 400 x 400mm aperture.

- SAQ2342V** HEKI AIR QUAD 23 - 42 ROOF THICKNESS VENTED
- SAQ4360V** HEKI AIR QUAD 43 - 60 ROOF THICKNESS VENTED

## SEITZ MINI HEKI SPOILER

- SHSMH** SEITZ MINI HEKI SPOILER



RFL420VNR



RFL2701VN



RFL47TVNRW



RFL4701VNRW



RFL4RPLVNRW Upgrade Kit



SEITZ MINI HEKI PLUS



MINI HEKI S



HEKI AIRQUAD

Ventilation

Buy securely online at [Leisurelines.net](http://Leisurelines.net)

WE NOW OFFER INSTALLATION AND REPAIR SERVICE BY [SupremeTech.co.uk](http://SupremeTech.co.uk)



0844 414 2324



0844 414 2425



# AIRCONDITIONING



## DOMETIC ROOFTOP AND UNDER BUNK AIR CONDITIONING UNITS



**B1600+ B2200 – B2600**

**B3200**

**HB2500**

The Freshjet 1100 is a super compact unit with aerodynamic design and a low weight. The B1600PLUS offers the advantage of an innovative air diffuser and ease of use of remote control. The Upper mid unit B2200 offers increased cooling and heating outputs, integrated lighting in the air diffuser & remote control. The NEW B2600 offers increased cooling capacity with a very efficient heating output of up to 3300 watts due to the innovative heat pump technology built into this unit. The rooftop range is completed with the powerful B3200 suitable and effective in cooling vehicles over 8 metres long. Due to its powerful performance this air conditioner is perfect for professional vehicles. Enjoy reliable and powerful heating and cooling even in adverse conditions such as frequent air changes. The HB2500 provides considerable cooling and heating capacity due to its innovative heat pump in a neat under bench package. Operated by remote control the air can be distributed in any suitable position to suit the installation with the optional air distribution accessories. See base of table for available HB2500 accessories.

Model	FR JET 1100	FRLITE 1600	FRLITE 2200	B1600PLUS	B2200	B2600	B3200	HB2500
Order Code	DAFJET1100	DAFLT1600	DAFLT2200	DAB1600	DAB2200	DAB2600	DAB3200	DAH2500
Cooling watts	1100	1550	2200	1500	2200	2500	3200	2500
Heating watts	-	2050	2700	800	1200	3300*	1600	3000**
Fuse ( A )	3	4	6	4	6	6	10	6
Weight	22	40	42	33	34	40.5	45	24.9
W x H x D	562 x 225 x 787	758 x 210 x 1105	758 x 210 x 1105	650 x 235 x 980	650 x 235 x 980	650 x 235 x 980	737 x 245 x 1025	400 x 280 x 710
Roof aperture	400 x 400	400 x 700	400 x 700	400 x 400	400 x 400	400 x 400	362 x 362	-
Roof thickness	25 – 60	25 – 60	25 – 60	30 – 80	30 – 80	30 – 80	25 - 100	-
Remote control	yes	yes	yes	yes	yes	yes	no	yes
Optional	DADCKIT1	DADCKIT2	DADCKIT2	DADCKIT2	DADCKIT2	DADCKIT2		
DC- Kit	DADCKIT3	DADCKIT3	DADCKIT3	DADCKIT3	DADCKIT3	DADCKIT4		DADCKIT3

12-volt mobile operation of air conditioners is possible with the optional DC kits. DC-Kit-1 / DC-Kit-2 Standard model with 1000 or 1600 watts continuous output. DC-Kit-3 Comfort model with 1500 watts continuous output. DAHB2500AIG2 Pair of Ø 190mm air inlet grilles. DAHB2500AIG 240 x 240mm Rectangular air grille. DAHB2500AOG Ø 60mm air outlet. DAHB2500CV 90° curve Ø 60mm. DAHB2500FLX10 Ø 60mm flexible ducting x 10 metres.

### DOMETIC FRESHJET 1100 NEW 1700 & 2200 MODELS

Compact design, Light weight of 22 kg, Circuit protection for campsites: 3 A delay fuse, Energy-saving and pleasantly quiet, All functions can be controlled by remote control, Integrated LED lights casting a warm, indirect light. The lighting can be dimmed, consumes little energy and has a long service life, Air distribution with four adjustable air vents, Perfect installation results, 1100 designed for vehicles lengths of up to 5 m, As a duo unit, ideal for creating separate climatezones in larger vehicles, 1700 up to 6m, 2200 up to 7m. Using the optional DC-Kit-1, -2 or -3 also for mobile operation (12 volts DC)

DAFJET1100 FRESHJET 1100  
DAFJET1700 FRESHJET 1700  
DAFJET2200 FRESHJET 2200

### NEW DOMETIC FRESHLIGHT AIRCON WITH INTEGRAL ROOF WINDOW

#### BRAND NEW AIR CONDITIONER WITH BUILT IN WINDOW

The New Freshlight is the worlds first powerful roof mount air-conditioner featuring the new built in acrylic window with single-pleated blind, delivering natural light into your vehicle. Also offer active ventilation bringing fresh air into the interior. Ideal for larger sized Motorhomes up to 7m. The proven air diffuser from the B2200 offers front & rear air distribution.

This powerful unit offers a special reverse cycle compressor providing an excellent cooling & heating performance of 2700watts. Energy-efficient heat pump system for cooling and heating & individual air flow regulation with automatic blower control.

A digital remote control unit for on/off, fan speed, temperature, & dimmable LED lights integrated into the air vent panel cast a pleasant, subdued light.

Dometic Fresh Light delivers cool and dehumidified air, free from dust and dirt. The internal diffuser has two internal air filters which can be removed & cleaned. A patented distribution system directs the air stream as desired.

The Freshlight can easily be retro fitted in replacement of your existing 400 x 400 roof vent & enlarging the cut-out to 700 x 400 (subject to the roof vent location, & roof space for the AC unit), alternatively it can be retro fitted with a new reinforced 700 x 400 roof cut out. A mounting frame & fixing kit with instructions are supplied.

If roof struts are in the way, an alternative cut out solution of 400 x400 for the main centre section of the AC unit, plus a further 200 x 400 for the forward moulding.

For stationary operation (230 Volts / AC 50 Hz). With DC-Kit-or DC-Kit-3 also for mobile operation on 12 volts DC. > Designed for vehicles up to 6 or 7 m long > Cooling capacity 1550 watts / 5300 Btu/h or 2200 watts / 7500 Btu/h > Heating capacity\* 2050 or 2700 watts max. > Power consumption in cooling / heating mode 950 / 1200 watts > Current consumption in cooling / heating mode 4.0 / 5.2 A > Number of blower speeds: 4 / automatic > Thermostat temperature control > Dimensions (W x H x D): 758 x 210 x 1105 mm > Dimensions window (W x D): 328 x 356 mm (inside) > Weight 42 kg

\* When the ambient temperature drops, the heating capacity of the heat pump reduces. We recommend you operate this at ambient temperatures of +2°C and above.

DAFLT1600 Freshlight 1600  
DAFLT2200 Freshlight 2200

WE CAN SUPPLY AND INSTALL THE FULL TELAIR RANGE OF AIRCONDITIONERS AS WELL AS THE NEW TRUMA UNITS. ASK FOR INFORMATION ON THESE RANGES.

WE NOW OFFER INSTALLATION & REPAIR SERVICE BY [SupremeTech.co.uk](http://SupremeTech.co.uk)



REMOTE CONTROL

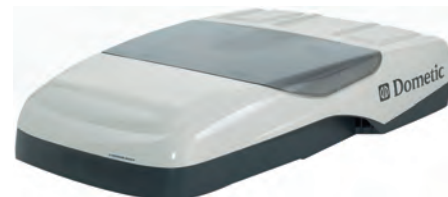

FRESH LIGHT

Ventilation

Buy securely online at [Leisurelines.net](http://Leisurelines.net)





# ROOF VENTS



## FIAMMA 160 ROOF VENTS

New high speed aerodynamic shape designed to reduce wind noise at speeds up to 140 km/h. New crystal dome lets in more light. Simple & functional ventilation for your caravan or motorhome, with wind up mechanism. It can be left open while travelling, and allows permanent ventilation when closed. Vent has double skin dome and is complete with mosquito net. Inner frame colour is white. Easily installed in 39x39 or 40x40 openings. KBA approved. Made from good quality UV-resistant materials. Will not fit 36x36 without modification to roofvent.

**FRV160C** FIAMMA VENT 160 40 X 40 WIND UP MECHANISM CRYSTAL  
**FRV160W** FIAMMA VENT 160 40 X 40 WIND UP MECHANISM WHITE

## FIAMMA TURBO-VENT 160 WITH POLAR CONTROL

The Turbo-Vent 160 ventilation fan roofvent is constructed from high quality materials. It exchanges air quickly with its variable speed 12v DC motor and 10 bladed fan. Electronic controls allow rapid change of direction of fan rotation. The version Polar Control has the electronic climate control thermostat controlling the fan operation to cool to your set temperature. The vent cover is opened and closed manually the centrally mounted arm pole provides increased stability against wind even while traveling with the cover open. Vent is provided with double mosquito screen to avoid accumulation of leaves and other debris that would impede operation of fan. Can be simply installed to any roof from 30mm to 85mm thick using the extension kit supplied as standard with the product. Absorbed power 33w, Current consumption min 0.5Amp, max. 2.6Amp, Max airflow, 35m<sup>3</sup>/min, Fan diameter 300MM.

**FTV160PC** TURBO-VENT 160 CRYSTAL + POLAR CONTROL  
**FTV160PW** TURBO-VENT 160 WHITE + POLAR CONTROL

## FIAMMA VENT 28 & TURBO VENT 28

New aerodynamic roof-vent fitted with or without 12v fan. Compact 28x28cm size makes it perfect for smaller motor caravan rooms such as shower & toilet. Made from superior quality impact and UV resistant materials. Due to internal installation system it is not necessary to drill fixing holes in the roof. Permanent airflow 50cm<sup>2</sup>. Fits minimum 30mm maximum 85mm thick roof (60 to 85mm with extension winder kit **FMEX70**). Turbo Vent 28 has a 170mm fan which provides airflow of 6.3 m<sup>3</sup> per minute. Electrical consumption 25Watt 1.9Amps 12volt.

**FRV28C** VENT 28 CRYSTAL  
**FRV28W** VENT 28 WHITE  
**FTV28FC** TURBO-VENT 28 CRYSTAL  
**FTV28FW** TURBO-VENT 28 WHITE

## FIAMMA UNIVERSAL SPOILER

New spoiler to fit most makes of roof vent on leading edge. It can be shortened to adapt itself to different rooflights with dimensions from 28cm to 110cm. Easily installed using sikaflex 512 (see page 115). Reduces wind noise of roof vents. Complete with smart lateral aerodynamic end caps. Size 110 cm wide 20 cm deep 12 cm high. Colour white.

**FRVSPUNIV** FIAMMA UNIVERSAL SPOILER

## FIAMMA SPOILER 40 X 40

Spoiler for Fiamma 40 x 40 roof vent or equivalent size models. Spoiler attaches to Fiamma vent fixing screws. It can fit most vents using the spacers provided. Spoiler can alternatively be simply installed with sikaflex 512. (See page 115) Colour white.

**FRVSP40** FIAMMA SPOILER 40 X 40

## FIAMMA WINDER EXTENSION 70MM

To extend winding handle of Fiamma wind up roof vents for increased roof thickness of up to 70mm.

**FMEX70** FIAMMA WINDER EXTENSION 70MM

## ROOF VENTILLATOR FAN

**VRF5252** Roof ventilator fan with air flow: max. 60 m<sup>3</sup>/h. voltage: 12 Volt, fully suppressed, consumption: 7 watts, opening in roof: Ø 95 mm, height above roof: 75 mm, cowl: Ø 200 mm, Colour light grey casing with light grey internal vent grille.

## DOMETIC DOME ROOF VENTILATORS

Dometic GY 11 Roof ventilator with motor, Voltage: 12 volts DC, Capacity: 70 / 125 m<sup>3</sup> / h, Power input: 30 watts, 2-speed fan, powerful ventilation, even when the engine is turned off, (3 to 12 m<sup>3</sup> / h at wind speed of 1 to 4 m / s), Weight: 0.6 kg, Roof dome dimensions (H x Ø): 64 x 200 mm, CE-approved.

**DRFGY11** DOMETIC GY11 ROOF VENTILLATOR 12v

Dometic GY 20 Roof ventilator, without motor, uses the differential pressure principle; efficient and noiseless operation without moving parts, Weight: 0.4 kg, Roof dome dimensions (H x Ø): 64 x 200 mm

**DRFGY20** DOMETIC GY20 ROOF VENTILLATOR

## CHROME PLATED PLASTIC VENTS

**V5201** Ventilation grill 175 x 40 recess mount into 168 x 34 profiled hole 12cm<sup>2</sup> ventilation area chrome plated plastic

**V5208** Ventilation grill 225 x 64 recess mount into 213 x 55 profiled hole 45cm<sup>2</sup> ventilation area chrome plated plastic

**V5211** Ventilation grill 57 x 57 recess mount into 50 x 50 profiled hole 10.2cm<sup>2</sup> ventilation area chrome plated plastic



Vent 160



Vent 160



Turbo Vent 160

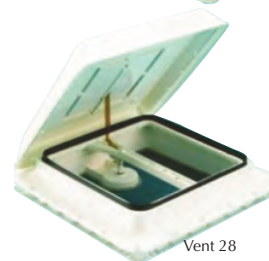

Vent 28

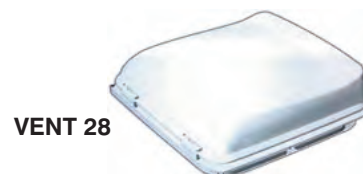

VENT 28



UNIVERSAL spoiler

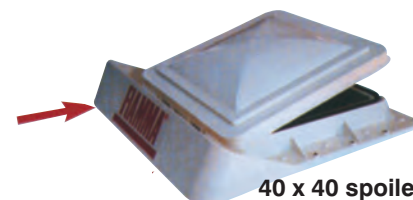

40 x 40 spoiler



FMEX70 Winder



DRFGY20



DRFGY11



VRF5252



V5201



V5208



V5211

WE NOW OFFER INSTALLATION & REPAIR SERVICE BY [SupremeTech.co.uk](http://SupremeTech.co.uk)



0844 414 2324



0844 414 2425

Ventilation

Buy securely online at [Leisurelines.net](http://Leisurelines.net)



# FAN VENTS, SOL-A-VENTS & FIXED VENTS



## ROOF MOUNTED VENTILATION FAN

The fan comes in 2 parts, a sleek aerodynamic fan assembly made from ABS to be mounted on the roof & a circular diffuser for installation on the underside of the ceiling. The internal diffuser contains 4 directional & closable airflow diffusers. The fan is 12 volt and consumes 3.5 Amps. Air throughput is 740m<sup>3</sup>/h. Switch allows fan to extract or blow air into compartment.

Dimensions external 318 x 308 x H 74 mm. internal 210mm diameter. Weight 2kg.

**AER01** ROOF MOUNTED VENTILATION FAN. 12 VOLT  
**AERSW** REVERSIBLE SWITCH FOR AER01

## SOL-A-VENT SOLAR POWERED VENTILATOR

Powered by nature our SOL-A-VENT provides solar powered silent and reliable ventilation for hot or humid areas. The models offer positive venting reducing condensation and heat build-up in your installation by drawing out high level air, including moisture, Airflow 11.3 cuft/min under full sun so can do a complete air change of an average motorhome in 90 minutes. Size OD 215mm, H 50mm above surface fixing flange 40mm below and Cut-out of 120mm diameter.

**SVB120W** SOL-A-VENT WITH WHITE ABS COWL  
**SVB120S** SOL-A-VENT MARINE VERSION WITH STAINLESS COWL

## NEW ROTARY ROOF VENTILATOR - V100RRV

Simple and very effective design ventilator. Air scoop powered by the wind in stationary applications or by the vehicles motion to provide airflow. Wind speed of 16km/hr gives 20m<sup>3</sup>/hr airflow, 48km/hr gives 133m<sup>3</sup>/hr and 96km/hr gives 280 m<sup>3</sup>/hr. Moulded from high quality white ABS with twin ball bearings for reliability. Roof opening 100mm dia fixing flange 139mm overall size above roof 123mm high x 242mm diameter. Internal vent grid 140mm diameter with 4 fixing holes that match those of the roof ventilator.

Use colour code after product code replace + with colour. Colours: BG = BEIGE, K = BLACK, W = WHITE, OW = CREAM.



AER01

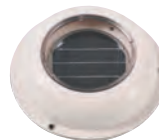

SV120W



SV120S

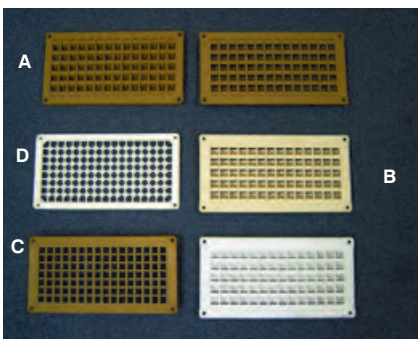

- A V7060+** Louvered vent surface mount 4000 mm<sup>2</sup> (OW,BG)
- B V7061+** Louvered vent (145 x 70 hole) 4000 mm<sup>2</sup> (W,OW,BG)
- C V7070+** 160 x 80 mm short tail vent 5200 mm<sup>2</sup> (BG, OW)
- D V7077BG** 163 x 85 x 6mm mesh surface mount vent 1765 mm<sup>2</sup>



**V7097W** Louvered external vent, 100mm dia tail. Ideal for cooker hoods

**V7100W** 100mm - 75mm adaptor to fit V7097W

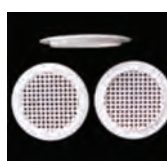

**V7084W** 90mm OD round short (4mm) tail vent (70mm hole)

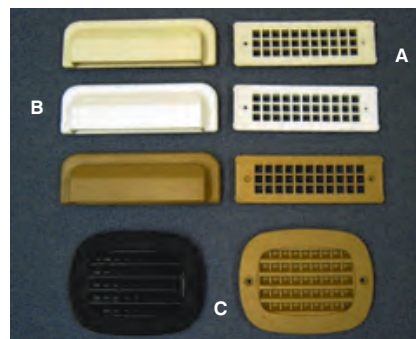

- V6995+** Rectangular vent (192 x 36mm hole) 3000 mm<sup>2</sup> (OW,K)
- V7090+** Rectangular vent (110 x 32mm hole) 2000 mm<sup>2</sup> (BG,OW,W)
- V6996+** Hood for v6995 thru wall vent (227x55) ( W )
- B V7091+** Hood for v7090 thru wall vent (132x32) ( BG, W, OW )
- C V7095+** Oval 2000 vent 128 x 98 (90 X 73 Oval hole) 2000 mm<sup>2</sup> (BG,K)

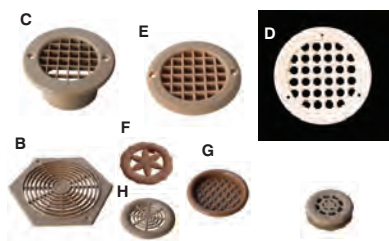

- A V7040BG** 28 mm X 3 mm ply twin sandwich vents
- A V7042BG** 28 mm X 6 - 7 mm ply twin sandwich vents
- A V7044BG** 28 mm X 12 - 16 mm ply twin sandwich vents
- B V7071BG** 3" hexagonal vent flat no tail
- C V7075BG** 75 mm OD round 38mm long tail vent (51 mm hole ) 760 mm<sup>2</sup>
- C V7088BG** 75 mm OD round 75 mm long tail vent (51 mm hole ) 760 mm<sup>2</sup>
- D V7076BG** 100 mm OD x 9 mm mesh round vent 1765 mm<sup>2</sup>
- E V7080 BG, W** 75 mm OD round short 12mm tail vent ( 55mm hole) 730 mm<sup>2</sup>
- E V7081BG** 75 mm OD round short 12mm tail louvered vent ( 51mm hole)
- F V7083BG** 1 1/2" star push in vent
- G V7085BG** Finger pull push in vent
- H V7087BG** 1 1/2" push in vent



**V3075BG** Castle top round mesh vent cover 54mm diameter. This cover will fit over the top of the 7075 /7080/7088 round vent to prevent luggage or any loose object from blocking the air flow.



### LARGE VENTS

High quality strong & stylish vents and winter covers for refrigerators and built in generators etc.

- V7051BW** Large vent 384 mm x 203 mm
- V7053BW** Winter cover 384 mm x 203 mm (For V7051BW)

HFS4504



**HFS4504** Long tail hole tidy/floor seal. 8- 15mm Pipe Seal 75mm Tail. Fits snug in 24- 25mm hole. Colour Off White

**HFS4504CTOP** castle top for above to use above as small vent

**HFS4504CTOP** Shown installed

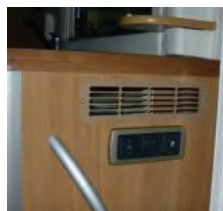

**V7065BG** 10000 mm<sup>2</sup> vent 312x86mm



**HFS7195K** FLOOR SEAL FOR 28MM WASTE PIPE SYSTEM



**HFS7178** 15-25MM FLOOR SEAL WITH 50MM TAIL

**V6998BG** The oval vent has a 6mm tail and is designed to fit through 6mm ply. The vent is an ideal product for giving ventilation to cupboards / lockers. Vent fits into a routed slot 197mm x 9mm.



**V7089BG** 15000 mm<sup>2</sup> vent OD 360x110mm

Use colour code after product code replace + with colour code. Colours: BG = BEIGE, BK = BLACK, W = WHITE, OW = CREAM

A WIDER RANGE OF VENTS AND HOLE TIDIES ARE AVAILABLE IN OUR ONLINE SHOP [LeisureLines.net](http://LeisureLines.net)

WE NOW OFFER INSTALLATION AND REPAIR SERVICE BY [SupremeTech.co.uk](http://SupremeTech.co.uk)

Ventilation

Buy securely online at [LeisureLines.net](http://LeisureLines.net)

**LED**



Quality downlight with 9 bright white LED's. Power 12v at 0.1A. Recess mounting without switch.  
**LED9777W** White  
**LED9777C** Chrome

**LED**



Quality downlight with 9 bright white LED's. Power 12v at 0.1A. Recess mounting with mini toggle switch.  
**LED9777SW** White with switch  
**LED9777SC** Chrome with switch



**LED**

**NEW** LED Rechargeable torch. Fits in Cigarette lighter /auto socket and recharges until needed. **LED661K**



**LED**

**LED0942C** Circular slim down light with 42 LED's. Aluminium base with chrome finish. Size 90 x H 7.3mm. Easy to install with one M4 screw.



**LED**

Ultra slim 48 LED light for surface or recessed mounting with switch. L 185mm x W 110mm, H surface mount = 24mm H recessed = 16mm.  
**LED48SLIMS** Silver grey case



**LED**

48 LED ultra slim waterproof white light No switch. 184 x 110 x 12mm H recessed fit or 20mm H surface mount. **IP66 waterproof**  
**LED48SLWPSG** Silver grey casing  
**LED48SLWPW** White casing



**LED**

Mini Swivel rail strip light ultra slim design with super bright white LED's with rocker switch. Silver casing grey ends. 12v. Light rotates 270 degrees. W 16 x H 21mm.  
**LED790SG** 10 LED Length 228mm  
**LED791SG** 20 LED Length 347mm



**LED**

**LED24SPOTSG** Swivel spot light with 24 bright LED's silver grey casing. With mini slide switch. Sizes base 42 x 80mm, Light height 86mm.  
**10w Halogen** version also available code **L939SG** 10W Halogen swivel spot light



**LED**

**LED035W** 2 x 35 cm 15LED self adhesive strip light.  
**LED050W** 2 x 50 cm 30LED self adhesive strip light.  
**IP66 WATERPROOF**



**LED**

**LED24335SG** Oval Swivel reading light new multi position lift and swivel design with 24 bright white LED's and mini switch. Light rotates 358 degrees. Size oval L 84 x W 75 x H 25mm. 6 Blue Led Night Lights



**LED**

Slim light with 24 bright white LED's. round mini rocker switch to end. 12v. Sizes L 390 x W 50 x H 33mm.  
**LED133C** Chrome casing  
**LED133SG** Silver grey casing  
**LED133W** White casing



**LED**

Slim rounded end 48 LED light 12v with switch. L 275mm x W 116 mm x H 32mm. **LED3045W** White case with diffuser.  
**LED3045SG** Silver Grey case with diffuser



**LED**

**LED2100C** Oval swivel interior light 6 LED with chrome base and switch. Size L 115 x W 77 x H 38mm. Ideal upgrade or replacement for aircraft style spots.



**LED**

Map reading light with 15 super bright LED's with mini rocker switch. Flex stalk 325mm long. With fixed mounting base or cigarette lighter plug. Colour Black with Silver Grey trim.  
**LED5066BK** with mounting base  
**LED5066CPK** with cigarette lighter plug



**LED**

Smart American RV style LED illuminated entry assist handle. Blue LED, no switch, chrome ends. Great add on, Definitely a talking point.  
**LEDRV EHC** 500mm version  
**LEDRV EHC800** New longer 800mm version

3 way switch. This usually means that there is either a small night light in halogen lights or a split to the total of LED's for all on or some on.

**WE NOW OFFER INSTALLATION & REPAIR SERVICE BY [SupremeTech.co.uk](http://SupremeTech.co.uk)**



**0844 414 2324**



**0844 414 2425**



Lighting  
Buy securely online at [Leisurelines.net](http://Leisurelines.net)

## AWNING LIGHTS



**LH285** Awning Light waterproof to IP66 with 10w halogen bulb. No switch. Length 248mm, Width 87mm, Projection off wall 55mm

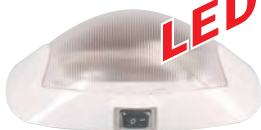

Exterior light with 18 LED  
**LED1122W** No switch  
**LED1122WS** With switch  
**IP65 WATERPROOF**

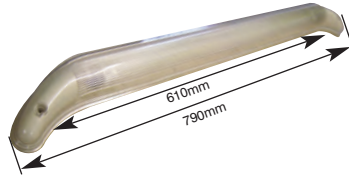

**New L173 EXTERIOR DOOR LIGHT IP44 WATERPROOF**  
New design long awning light arched over entrance door top. Built in rain channel to direct water away from door. 13w fluorescent tube light 12 volt DC. Clear lens and outer cover inner casing white. Requires switch  
**L173W** Long exterior door light 13w tube

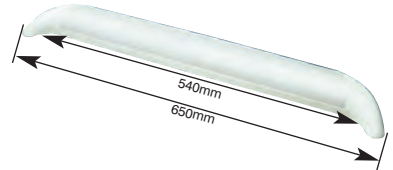

**L170 EXTERIOR DOOR LIGHT IP44 WATERPROOF**  
New style awning light arched over entrance door top. Very smart design easily installed to exterior. Requires switch. 12 volt only. White.  
**L170W** L170 exterior door light 8w tube.



**LED666W** Awning light with 48 super bright LEDs. White case Size 325L x 100W x 50H. **IP65 WATERPROOF**



**LED777W** awning light with 30 super bright LED's Case Size 200L x 100W x 50H  
**IP66 WATERPROOF**



**LEDLL2** ASTRO awning light 24 bright white LED's **IP66 waterproof** Size L 592 x W 43 x H 30mm (12v 2.2w) No switch.



**LEDLL2CW6** POWER ASTRO compact awning light 6 white CREE LED's **IP66 waterproof** Size L 343 x W 43 x H 31mm (12v 2.2w) No switch.



**NEW** LED Exterior Awning light with 12, 24 or 36 super bright LED'S. Size 30mm W x 25mm H 45 degree angled down LED's Colour **WHITE IP66 WATERPROOF**  
**LED395012** 12 LED 265mm Long  
**LED395024** 24 LED 465mm Long  
**LED395036PIR** 36 LED with PIR



**LHSPOTC** 15W halogen spot lamp 12 V. Smart spot lamp with round base and switch 86 mm diam. base + swivel arm + lamp height 120 > 150 mm  
**LHSPOTC** 15W halogen spot lamp (matt nickel)



**LHSPOTA** 15W halogen spot lamp 12 V. Single spot lamp with round base and switch 86 mm diam. base + swivel arm + lamp height 120 > 150 mm  
**LHSPOTA** 15W halogen spot lamp (matt nickel)



**LHSPOT3A** 3 X 15W halogen spot lamp 12 V. Smart styled spot lamps, round base no switch 240 mm diam. base + swivel arm + lamp height 120 > 150 mm  
**LHSPOT3A** 3 X Swivel spot + base (mat nickel)



**LEDSPOT112** 9 LED single spot lamp with round base and switch 60 mm Ø. base + swivel arm + lamp height 90 mm  
Brushed stainless steel & Chrome  
12v 0.5w



**LEDSPOT114** 9 LED single spot lamp with round base and switch 60 mm Ø. base + swivel arm + lamp height 90 mm  
Brushed stainless steel & Chrome  
12v 0.5w



**LED2MINIW** Micro courtesy light with 2 bright white LED's. White casing no switch. Sizes L 43 x W 20 x H 15mm.  
**IP 66 WATERPROOF**



Strip led courtesy light Dual 12/24 Voltage  
Size W 25mm x H 19mm  
**LED298** 4 LED L = 90mm  
**LED2104** 10 LED L = 176mm  
**IP 66 WATERPROOF**



Dome Light with 21 bright white LED's & 9 red LED's night light. Sizes 150 Ø x H 25mm. **IP66 Waterproof**. No switch.  
**LED21688SG** silver grey casing  
**LED21688SS** silver sand casing  
**LED21688W** white casing



Dome Light with 21 bright white LED's. Sizes 150 Ø x H 25mm. IP66 Waterproof  
**LED21689SS** silver sand with switch  
**LED21689SG** silver grey with switch  
**LED21689W** white with switch



Waterproof recessed slim ceiling light with 30 bright white LED's. 12v. Sizes L 164 x W 103 x H 40mm in recess + only 7mm on surface. **IP66 waterproof**  
**LED5130** White casing ends

WE NOW OFFER INSTALLATION & REPAIR SERVICE BY [SupremeTech.co.uk](http://SupremeTech.co.uk)



# SMARTLITE™ MODERN STYLISH LED LIGHTING RANGE



New range of ultra slim lights with built in innovative **TOUCH SWITCH** technology. Simply touch the surround to turn light on or off.



**NEW LED3056SGTS** 30 LED Ultra slim light with Innovative **TOUCH SWITCH** Size 69mmØ x H 9.6mm **IP66 WATERPROOF**



**NEW 72 LED slim dome light with Innovative TOUCH SWITCH** Size 129mmØ x H 9mm **LED8812SG** no switch **LED8812SGTS** touch switch **IP66 WATERPROOF**



**NEW LED8818SG** 144 LED ultra slim dome light with No Switch Size 196mmØ x H 9.5mm **IP66 WATERPROOF**



**NEW LED Exterior Awning light with 12, 24 or 36 super bright LED'S.** Size 30mm W x 25mm H 45 degree angled down LED's Colour **WHITE IP66 WATERPROOF**  
**LED395012** 12 LED 265mm Long  
**LED395024** 24 LED 465mm Long  
**LED395036** 36 LED 665mm Long



**NEW LED355030** 30 super bright LED rigid light bar with 2mtr connecting cable and auto plug. Size 19mm W x 10mm H x 500mm Long **IP66 WATERPROOF**



**NEW LED Rigid light bar with connectors both ends for interconnecting multiple light bars.** Aluminium base 15mm wide. With magnets to rear and mounting clips  
**LED385018** 18 SUPERBRIGHT LEDS  
**LED385036** 36 SUPERBRIGHT LEDS



**75 LED Waterproof slim recessed light 75 bright white LED's.** 12v. Sizes L 372 x W 138 x H 23mm in recess + only 6mm on surface. **IP66 waterproof**  
**LED5375W** White casing ends



**NEW Flexible soft tape LED's 10mm wide self adhesive.** 60 superbright LED's per mtr. Can be cut and rewired every 3 LED's **IP66 WATERPROOF**  
**LED50501** flexible 1mtr with wiring tails  
**LED50502** flexible 2mtr with wiring tails  
**LED50505** flexible 5mtr with wiring tails



**NEW LED283SG SURFACE MOUNT rotate & SWIVEL SPOTLIGHT** 6 SUPERBRIGHT LEDS Size 80 Ø x 48mm H



**LED101SG** 6 SUPERBRIGHT LED Recessed or surface mount down lighter. Sizes: Ø 75 x 8mm recessed requires 56mm hole. Surface mounted 78mm Ø x 19mm H. With centre illuminated blue switch.



**LED103SG** 24 white & 3 blue nightlights LED's Recessed or surface mount down lighter. Sizes: Ø 75 x 8mm recessed requires 56mm hole. Surface mounted 78mm Ø x 19mm H. With centre switch.



**LED20RCSMN** 20 LED Recessed or surface mount down lighter. Sizes: Ø 50 x 20mm recessed. Surface box 64mm Ø x 26mm H. no switch



**NEW LED20SHSMN** LED Fixed recessed downlight of superb quality with 20 LED's for high output. Connect to 12volt DC. 1.2w Size 70mm Ø x 17mm recessed.



**NEW LED30FSRMN** LED Fixed recessed or surface mount with surround supplied. Led downlight of superb quality with 30 LED's for high output. Connect to 12volt DC. 1.8w Size 70mm Ø x 17mm recessed or 32mm High surface mounted.



**NEW LED42FSRMN** LED Fixed recessed or surface mount with surround supplied. Led downlight of superb quality with 42 LED's for high output. Connect to 12volt DC. 2.5w Size 70mm Ø x 17mm recessed or 32mm High surface mounted.

WE NOW OFFER INSTALLATION & REPAIR SERVICE BY [SupremeTech.co.uk](http://SupremeTech.co.uk)



0844 414 2324



0844 414 2425

Lighting

Buy securely online at [Leisurelines.net](http://Leisurelines.net)



# SMARTLITE™ LED LIGHTING RANGE



New additions to the Smartlite™ range for 2008. Add the following colour codes to end of code, W=White, C=Chrome, S=Silversand.



**LFR2094AL** Mini Tube  
**LFR2095AL** Up Down Mini Tube WITH SWITCH



**LFR9661C** 36LED MINOR CHROME EASY SPRING MOUNTING INTO 50MM HOLE

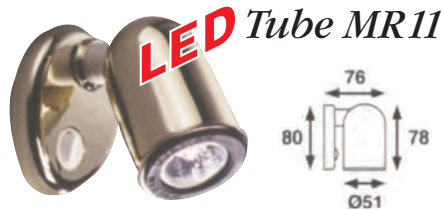

**LFR9005C** Chrome LED with switch.  
**LFR9006SL** Silversand. LED Bulb 1W with switch.

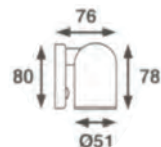

**LFR9680MC** GLEAM 46 18SMD LED MATT CHROME



**LFR9688BS** VEGA 48 18SMD LED BRUSHED STEEL Easy fit pushed into a 40mm hole 5mm deep

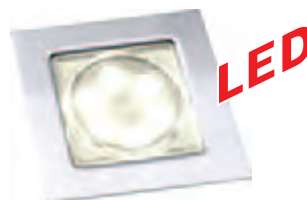

**LFR9690BS** VEGA 48 SQUARE 18 SMD LED BRUSHED STEEL Easy fit pushed into a 44mm hole 5mm deep



**LFR9692MC** VEGA 75 36SMD LED MATT CHROME Easy fit pushed into a 60mm hole 5mm deep



**LFR9695MC** SQUARE 50 - 24 SMD - MATT CHROME



**LFR8870C** Chrome LED 20mA **LFR8871C**BLUE LED **LFR8872C**RED LED IP65 WATERPROOF

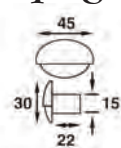

**LFR9775C** NOVA - 36 SMD - CHROME



**LFR9796BS** FLAME - 78 36 SMD - BRUSHED STEEL

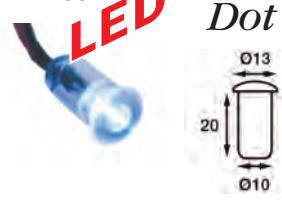

Single push in LED 20mA **LFR8878V** white LED **LFR8878B** blue LED IP65 WATERPROOF



**KURZ Co-pilot** flexi stalk, **New** LED version. Toggle switch built into light head. Base 35 x 45mm, Overall length 130mm=260mm, 330mm=450mm  
**LFR9447C13L** 130mm flexi, LED Black  
**LFR9447L33L** 330mm flexi, LED Black  
**LFR9447MS13L** 130mm flexi, LED Matt Silver  
**LFR9447MS33L** 330mm flexi, LED Matt Silver



**LFR9117MCS** SATURN 2



Stringlight White LED 12v 1.2w/m. 12.5mm dia  
**LFR93501** 1 mtr long  
**LFR93502** 2 mtr long  
IP65 WATERPROOF

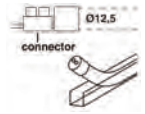

**LFR9230** Flat 300mm striplight 15 White LED 12v 75mA can be linked max 24metres. IP64 WATERPROOF



**LFR9330.** Flex 300mm striplight 15 White LED 12v 50mA can be linked max 40 pieces.

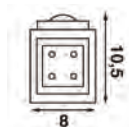

WE NOW OFFER INSTALLATION & REPAIR SERVICE BY [SupremeTech.co.uk](http://SupremeTech.co.uk)

Lighting

Buy securely online at [Leisurelines.net](http://Leisurelines.net)



quality downlight with 9 bright white LED's. Power 12v at 0.1A. Surface mount or remove ring for recess mount. 79mm Ø x 19 or 7mm high  
**LED9099SGS** Silver grey with switch.  
**LED9099WS** White with switch



quality downlight with 9 bright white LED's. Power 12v at 0.1A. Surface mount or remove ring for recess mount 79mm Ø x 19 or 7mm high.  
**LED9099SG** Silver grey No switch.  
**LED9099W** White No switch



stylish downlight with 9 white diffused LED's. Power 12v at 0.1A. Surface mount or remove ring for recess mount. With rocker switch 80 Ø x 25 or 10mm high  
**LED900SG** Silver grey  
**LED900SS** Silver sand



smart reflector down light with 9 bright white LED's. Power 12v at 0.1A. Surface mount or remove ring for recess mount. With rocker switch. 80 Ø x 25 or 10mm high  
**LED901SG** Silver grey  
**LED901SS** Silver sand



75 LED Waterproof slim recessed light 75 bright white LED's. 12v. Sizes L 372 x W 138 x H 23mm in recess + only 6mm on surface.  
**IP66 waterproof**  
**LED5375W** White casing ends



**LED817SS** Single diffused LED midi lamp with switch. 12v Silver sand  
 Size 210mm Long x 125mm W x 43 mm



**LED818SS** Double diffused LED midi lamp with 3 way switch. 12v Silver sand  
 Size 280mm Long x 125mm W x 43 mm



**LFR8658C** Chrome G4 10W with switch.  
**LFR8658S** Silversand G4 10W with switch.  
**LFR9658C** Chrome LED with switch.

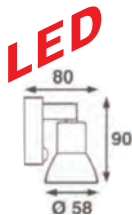

LED Oval fixed down light superb quality with 20 or 30 LED's for high output. Connect to 12volt. Size 108mm L x 59mm W x 22mm high. **IP44 WATERPROOF**  
**LED300VST** 30 LED Brushed Stainless  
**LED200VST** 20 LED Brushed Stainless



**LEDSPOT9SG** Swivel spot light with 9 super bright LED's. Silver grey casing. With mini slide switch. Sizes base 42 x 80mm, Light height 86mm.



**LFR8658C** Chrome G4 10W with switch.  
**LFR8658S** Silversand G4 10W with switch.  
**LFR9658C** Chrome LED with switch.



**NEW LED2299K** Waterproof LED worklight. Black coated robust aluminium die cast housing. 6 x 1.2w hi-power led's. Complete with 2 mtrs of cable. Size 102W x 42D x 92H inc mounting bracket. **IP66 WATERPROOF**



**NEW LED2300K** Waterproof LED Marine worklight. Black coated robust aluminium die cast housing. 6 x 2.5w ULTRA Hi-Power led's. Complete with 2 mtrs of cable. Size 115Ø x 95D x 150H inc mounting. **IP66 WATERPROOF**



**L871FG** Midi Swivel Strip design with 8W fluorescent tube & 3w night light.



**LFR8311C** Chrome. With switch  
 Bulb G4 10W Halogen.

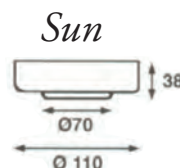

**LFR8777C** Chrome G4 10W without switch.  
**LFR8777S** Silversand G4 10W without switch.  
**LFR8777CS** Chrome G4 10W with switch.  
**LFR8777SS** Silversand G4 10W with switch.



3 way switch. This usually means that there is either a small night light in halogen lights or a split to the total of LED's for all on or some on.

**WE NOW OFFER INSTALLATION & REPAIR SERVICE BY [SupremeTech.co.uk](http://SupremeTech.co.uk)**



0844 414 2324



0844 414 2425



# MODERN STYLISH LED LIGHTING RANGE



Lighting

Buy securely online at [Leisurelines.net](http://Leisurelines.net)



**NEW LED250120SG** slim strip light 48 LED Size L 200 x W 93 x H 16mm. Silver grey with switch  
**NEW LED250130SG** slim strip light 96 LED Size L 300 x W 93 x H 16mm. Silver grey with switch



**NEW LED250140SG** slim strip light 144 LED Size L 400 x W 93 x H 16mm. Silver grey with switch  
**NEW LED250160SG** slim strip light 240 LED Size L 600 x W 93 x H 16mm. Silver grey with switch



**NEW** Narrow strip light silver grey with switch. W 45mm x H 10.4mm  
**LED251024** 24 LED L=158mm  
**LED251048** 48 LED L=265mm  
**LED251072** 72 LED L=368mm  
**LED251096W** 96 LED L=368mm



LED fixed recessed down light superb quality with 20 LED's for high output. Connect to 12volt 1.2w. Size 70mmØ x 4+19mm high  
**LED20FSMN** Brushed nickel  
**LED20FSC** Chrome



**NEW** Slim downlight 30 LED Size 83mmØ x H 12mm. Lens 50mmØ Silver grey casing.  
**LED30100SG** 30 LED no switch  
**LED30100SSG** 30 LED + switch  
**IP66 WATERPROOF**



**NEW LED9001SG** Ceiling light with 96 LED and 6 SMD blue LED night light with 3 position switch. Size L 177 x W 177 x H 20mm. Silver grey

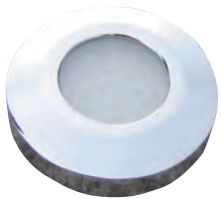

LED High Quality Chrome spotlight with 21 LED's. 12 volt 1.3w.  
**IP44 WATERPROOF**  
Size 92mmØ x 20mm high.  
**LED21FSC** CHROME 21 LED WATERPROOF



**LED02212** Mini recessed downlighter with 12 super bright LED's. Size 43mmØ.  
**VERY POPULAR LIGHT DUE TO BRIGHTNESS AND COMPACT SIZE**



**NEW LED1067SG** 3 SMD LED step / courtesy light/ cupboard light. Size L 86 x W 33 x H 10mm. Silver grey case.  
**IP66 WATERPROOF**



**NEW LED1069SG** 6 SMD LED step / courtesy light/ cupboard light. Size L 131 x W 29 x H 11mm. Silver grey case.  
**IP66 WATERPROOF**



**LED S15500** NEBULA strip light 30 bright white LED's in a weatherproof case Size L 625 x W 44 x H 15mm (12v 2.2w) With switch.



**LED LLL3** Pole light 30 bright white LED's no switch. Pole size L 550 x Ø 35mm end cap Ø 75mm (12v 2.2w)



**LED CW500** Orion mini strip light. 24 bright white LED's Size L 522 x W 18 x H 11mm (12v 2.2w) No switch.



**CALLISTO** super- bright white LED Size 58mm Ø x H 4mm Cut out 38mm Ø x D 10mm. Matt nickel No switch.  
**LED L10WP** IP67 waterproof  
**LED L10** NON waterproof



Recessed fixed downlighter Size flange 82mm Ø x H 4 mm Cut out 55m Ø x D 30mm  
**LED9676C** SMD LED



Swivel recessed downlighter Size flange 82mm Ø x H 4 - 14mm Cut out 58m Ø x D 21mm  
**LED9780C** SMD LED



Surface mounted switched base with swivel light. 12v dc 1w. Size flange 101mm Ø x H 37mm  
**LED9710C** SMD LED

WE NOW OFFER INSTALLATION & REPAIR SERVICE BY [SupremeTech.co.uk](http://SupremeTech.co.uk)



[www.caktanks.com](http://www.caktanks.com)



[sales@caktanks.co.uk](mailto:sales@caktanks.co.uk)





## SPARE FLUORESCENT TUBES & HALOGEN BULBS

- A LST4W Spare 4w tube
- B LST8W Spare 8w tube (300mm)
- B LST13W Spare 13w tube (525mm)
- B LST18W Spare 18w tube (590mm)
- B LST21W Spare 21w tube (850mm)
- C LSPL7 Spare PL7 dulux tube
- C LSPL9W Spare PL9 dulux tube
- D LSPL11W Spare PL11 dulux tube
- D LST2D10 Spare 2D 10w tube
- E LST2D16W Spare 2D 16w tube
- F LSG41210 G4 halogen 12v 10w
- F LSG41220 G4 halogen 12v 20w
- F LSG42420 G4 halogen 24v 20w
- F LSB21W 21W 12v bulb for L9025w
- F LSB5W 5W courtesy light bulb
- F LSTF10 10w round tube
- G LSMR11121 HAL MR11 12 volt 10w
- H LSMR16122 HAL MR16 12V 20W

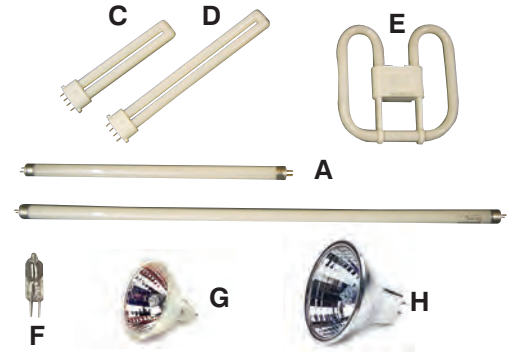

**B6869BG** Down light back box designed to cover the rear of halogen spots where they have been cut into the underside of overhead lockers etc. preventing contents touching hot parts of the lamp.  
New **B6867BG** with 50mm w x 25mm h cut out to side for harness plugs.



**Dometic LIGHT LED23RM**  
Elegant recessed spotlight with low depth integrates easily into any interior. Can be used as room lighting. Uses economical LEDs.  
Voltage: 8 – 16 volts DC.  
Output: 1 watt. Bulb: G4 PCB, side pin, power-LED. Light colour: warm white. Material: metal, glass. Ø x D: 65 x 20 mm



**Dometic LIGHT LED20RM**  
Swiveling recessed spotlight with ON / OFF switch. Uses economical LEDs. Voltage: 8 – 16 volts DC. Output: 1 watt. Bulb: G4 back pin long, power-LED. Light colour: warm white. Material: plastic,



**Dometic LIGHT LED21TM**  
Swiveling surface-mounted spotlight with ON / OFF switch. Uses economical LEDs. Voltage: 8 – 16 volts DC. Output: 1 watt. Bulb: G4 back pin long, power-LED. Light colour: warm white. Material: plastic, glass. Ø x D: 85 x 60 mm



**Dometic LIGHT LED30TM**  
Strip light for fitting on top of cupboards by means of adhesive strip. Voltage: 8 – 16 volts DC. Output: 2.5 watts. Bulbs economical LED's. Light colour: warm white. Material: metal. W x H x D: 860 x 30 x 12 mm



**Dometic LIGHT LED19TM**  
Pivoting and swiveling surface mounted spotlight with ON / OFF switch. Uses economical LEDs. Voltage: 8 – 16 volts DC Output: 1 watt, Bulb: G4 back pin long, power-LED. Light colour: warm white. Material: plastic, glass Ø x D: 75 x 85 mm



**Dometic LIGHT LED24TM**  
Pivoting and swiveling surface mounted spotlight with ON / OFF switch. Low heat emission thanks to LED cold light. Voltage: 8 – 16 volts DC. Output: 0.75 watts. Bulb: MR16 LED Light colour: warm white. Material: aluminium Ø x D: 75 x 100 mm



**Dometic LIGHT LED25TM**  
Pivoting and swiveling surface mounted spotlight with ON / OFF switch. Low heat emission thanks to LED cold light. Voltage: 8 – 16 volts DC. Output: 0.75 watts. Bulb: MR16 LED Light colour: warm white. Material: plastic, glass. Ø x D: 75 x 120 mm



**Dometic LIGHT LED26RM**  
Elegant recessed spotlight with low depth integrates easily into any interior. Can be used as room lighting. Voltage: 8 – 16 volts DC. Output: 1 watt. Bulbs: G4 PCB, side pin, 10 smd LED. Light colour: warm white. Material: plastic, glass Ø x D: 70 x 14 mm. With 3 colour rings, chrome, matt nickel or soft gold.



**Dometic LEDLK120** Led light kit for awnings. Convenient operation with remote control hand transmitter. Dimming function, Suitable for all types of awnings, Energy-saving LED, Easy installation (12 V) Length: 2 x 1.20 m (flex strip with 60 SMD diodes per metre, can be cut every 5 cm, self-adhesive, adheres also to uneven surfaces). Bulbs: SMD LED / light colour: warm white, Output: 3.6 watts/m, Illumination: 240 lm/m



**NEW! FLEXLIGHT ON ROLL SMD flex strip with adhesive surface.**  
Input voltage: 8 – 16 volts DC. Bulbs: SMD LED, Material: Epoxy resin, Self-adhesive, also adheres to uneven surfaces, only for indoor use available in 2 versions: with 30 LEDs 120lm/m 1.8watts / m (FB 130 to 530) or 60 LEDs 240lm/m 3.6watts / m (FB 160 to 560) per metre. Size: 8 x 3mm x product length.



**Dometic LEDTL470** Elegant design, for use as reading light or in entry areas, the middle section between the two mounts can be turned. Voltage: 8 – 16 volts DC. Output: 1.2 watt. 20 LED. Light colour: warm white. Material: plastic, aluminium. W x H x D: 470 x 20 x 20 mm



**Dometic LED28TM** Cabinet light with magnetic contact switch, battery-powered. Designed for custom use, e.g. in cupboards and storage compartments or in the safe. Attached by adhesive strip. Internal 4.5v battery powered. W x H x D: 30 x 65 x 20 mm



**Dometic LFFB8** Remote control with dimming function for LED lights. Max. load 8 A, Functions: On / off / brighter / darker. Input voltage: 12/24 volts. Control box W x H x D: 290 x 35 x 50 mm

- 30 LED 's per metre
- LEDFB130 1000MM
- LEDFB230 2000MM
- LEDFB330 3000MM
- LEDFB430 4000MM
- LEDFB530 5000MM

- 60 LED 's per metre
- LEDFB160 1000MM
- LEDFB260 2000MM
- LEDFB360 3000MM
- LEDFB460 4000MM
- LEDFB560 5000MM



WE NOW OFFER INSTALLATION & REPAIR SERVICE BY [SupremeTech.co.uk](http://SupremeTech.co.uk)



0844 414 2324



0844 414 2425



# NEW LED REPLACEMENT BULB RANGE



Lighting  
Buy securely online at [Leisurelines.net](http://Leisurelines.net)



LEDBS4TS18CW



LEDBS4TS15  
Superbright SMD



LEDBS4S10  
Superbright SMD



LED SG4S10  
Superbright SMD

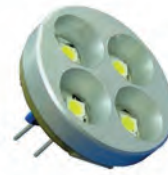

LEDBS4U4  
Ultra bright SMD



LED SG4U4  
Ultra bright SMD



LED F37S6

LED F37S3



NEW LED F42S9  
Superbright SMD



NEW LED BA15ST18  
LED BA15DT18  
Superbright SMD



NEW  
LED BA15SS6  
LED BA15DS6  
Superbright SMD



NEW LED ST1010  
Superbright SMD



NEW LED ST2018  
WEDGE 7440  
Superbright SMD



NEW LED BA15SF9  
Superbright SMD

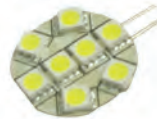

NEW LED SG408CW  
LED SG408WW

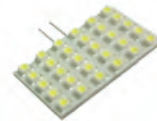

NEW LED SG4S30CW  
Superbright SMD



NEW LED BS4S12CW  
Superbright SMD  
DIRECT HALOGEN  
REPLACEMENT



LED SG4R6CW



NEW LED MR806CW  
LED MR806WW



NEW  
LED MR1110CW  
LED MR1110WW



NEW  
LED MR11S6CW



NEW LED MR1610



NEW LED MR1615



LED BA9ST15CW



LED BA9S6CW



LED BA15S42CW



NEW  
LED BA15ST30  
LED BA15DT30  
Superbright SMD



NEW  
LED BA15ST60  
LED BA15DT60  
Superbright SMD



LED BA15S12SDCW



NEW LED T5 TUBE 30CW Specially designed to replace the T5 8 watt fluorescent tube. Inverter and electronics must be removed from light. End connectors must be then re wired direct to the light switch to provide 12volt direct to the 30 LED tube. Using 30 LED tube directly in a fluorescent light without rewiring will destroy the 30 LED tube. This damage is not covered under warranty. (Approx 300mm inc pins)

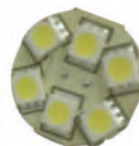

NEW LED BS4S6WW  
G4 BASE MOUNT  
SUPER BRIGHT LEDS



NEW LED SG4S6CW  
G4 SIDE MOUNT  
SUPER BRIGHT LEDS



NEW LED SG409RGB  
G4 SIDE PIN RGB  
COLOUR CHANGING



NEW BA15D & BA15S adaptors allow installation of any 2 pin G4 Led module to be installed.  
LED BA15SG4A LED BA15DG4A

LED  
Electricity consumption



BATTERY  
HALOGEN  
Electricity consumption



THIS IS JUST A SELECTION OF OUR LED BULBS. WE HAVE MANY NEW DESIGNS IN DEVELOPMENT.

Use only an eighth of the battery power with LED



# NEW LED REPLACEMENT BULB RANGE



## NEW LED REPLACEMENT BULB RANGE SAVE BATTERY POWER WITH YOUR LIGHTING

Replace your power hungry halogen bulbs with energy efficient LED.

Low energy consumption with significant light performance. The bulb contains white LED's built into a plastic or glass housing, the LED's have 90° beam angle (wide) for significant light output. Light output for 21 LED's Cool White is approx equivalent to a 15W halogen while power consumption is only 1.3 watts, 110mA. For comparison, a traditional 10W halogen G4 bulb consumes 10 watts (0.81A). So you can have 8 LED bulbs on for the power use of one Halogen bulb!! Great for rallying and wild camping, no flat battery worries.

We have two versions of white light, Cool White (CW) which is the brighter giving the maximum output great for reading & Warm White (WW) which has a little more orangey-red in the light and a little less blue-white giving a slightly less bright but homely light. Because it is LED it produces practically no heat. If you had the bulb on for 3 hours it would still be no warmer than your hand. Compare this to a halogen on for just 5 minutes. Great safety for children.

All our bulbs have a built in voltage regulator for direct use on DC voltages from 11-15 Volts.

Special versions also available for 23-30 Volts for 24 Volt systems.

**SIDE MOUNTING LED G4 VERSION:** This LED bulb is suitable for side mounting into light units such as down lighters and multi bulb ceiling lights. The bulb can be fitted into down lighters with or without the protection glass being refitted. Connections are 2 pins same as the G4 standard projecting from the side of the casing. There are two sizes as shown in the table below.

**BASE MOUNTED 21 LED G4 VERSION:** Connections are 2 pins as the G4 standard projecting from the base of the casing. The bulb will replace the spotlight halogen and vertically mounted G4 halogen bulbs.

**BASE MOUNTED 9 & 12 LED MR11 VERSION:** Connections are 2 pins as the G4 standard projecting from the base of the casing. The bulb will replace the spotlight halogen and vertically mounted G4 halogen bulbs.

**BASE MOUNTED 20 & 30 LED MR16 VERSION:** Connections are 2 pins as the G5.3 standard projecting from the base of the casing. The bulb will replace the MR16 spotlight halogen bulbs.

**BASE MOUNTED LED BA15D BAYONET VERSION:** Connection is the BA15D double contact standard bayonet cap on the base of the casing. The bulb will replace the BA15D bayonet bulbs in most situations.

**BASE MOUNTED LED BA15S BAYONET VERSION:** Connection is the BA15S single contact standard bayonet cap on the base of the casing. The bulb will replace the BA15S bayonet bulbs in most situations.

**T5 TUBE LED:** Specially designed to replace the T5 8 watt fluorescent tube. Inverter and electronics must be removed from light. End connectors must be then re wired direct to the light switch to provide 12volt direct to the LED tube. Using LED tube directly in a fluorescent light without rewiring will destroy the LED tube. This damage is not covered under warranty.

Simply replace this



with this



LEDSG421  
(side mount)



	Part No. Cool White	Part No. Warm White	No of LED's	Voltage DC	Watts	Casing Diameter	Overall Depth (excluding pins)	Casing Colour
<b>G4</b>	LEDBS4S12CW	LEDBS4S12WW	12 SB	10-30	0.8	8 mm	20mm	
<b>G4 Side Mounted</b>	LEDSG4S6CW	LEDSG4S6WW	6 SB	10-30	2	22 mm	10 mm	
	LEDSG4R6CW	-	6 SB	11-15	1.2	25 x 16	9 mm	
	-	LEDSG421WW24	21	23-30	1.2	31 mm	11 mm	White
	LEDSG408CW	LEDSG408WW	8 SB	10-30	2	25 mm	8 mm	
	-	LEDSG414WW	14	11-15	0.7	25 mm	11 mm	White
	LEDSG4S10CW	LEDSG4S10WW	10 SB	8-30	2	30 mm	8 mm	-
	LEDSG4U4CW	-	4 UB	8-30	1.2	24.5 mm	10 mm	Aluminium
	LEDSG409RGB	-	9 RGB	10-30	-	30 mm	10 mm	
	LEDSG4S30CW	-	30	10-30	1.5	41 x 23	8 mm	
	<b>G4 Base Mounted</b>	LEDBS4TS15CW	LEDBS4TS15WW	15 SB	8-30	1.44	13 mm	18 mm
LEDBS4TS18CW		-	18 SB	10-30	2	19 mm	23 mm	
-		LEDBS421WWC	21	11-15	1.2	37 mm	25 mm	Aluminium
LEDBS4S10CW		LEDBS4S10WW	10 SB	8-30	2	30 mm	8 mm	-
LEDBS4S6CW		LEDBS4S6WW	6 SB	8-30	2	23 mm	8 mm	
<b>MR8</b>	LEDBS4U4CW	LEDBS4U4WW	4 UB	8-30	1.2	24.5 mm	10 mm	Aluminium
	LEDMR806CW	LEDMR806WW	6 SB	10-30	1.5	25 mm	27 mm	Glass
<b>MR11</b>	LEDMR1110CW	LEDMR1110WW	10 SB	10-30	-	35 mm	30 mm	Glass
	LEDMR11S6CW	LEDMR11S6WW	6 SB	10-30	1.5	35 mm	30 mm	Glass
<b>MR16</b>	LEDMR1610CW	LEDMR1610WW	10 SB	10-30	2.5	50 mm	38 mm	Glass
	LEDMR1615CW	LEDMR1615WW	15 SB	10-30	3	50 mm	38 mm	Glass
<b>BA9</b>	LEDBA9S6CW	-	6	10-16	0.5	10 mm w	28 mm	
	LEDBA9ST15CW	-	15	10-30	2.1	13 mm	34 mm	
<b>Bayonet BA15D</b>	-	-	-	-	-	-	-	-
	LEDBA15DS6CW	LEDBA15DS6WW	6 SB	8-30	1.3	27 mm	38 mm	-
	LEDBA15DT60CW	LEDBA15DT60WW	60	8-30	5	25 mm	67 mm	-
	LEDBA15DT30CW	LEDBA15DT30WW	30	8-30	3.6	25 mm	46.5 mm	-
	LEDBA15DT18CW	LEDBA15DT18WW	18 SB	8-30	3.6	22 mm	55 mm	-
<b>Double Contact</b>	-	-	-	-	-	-	-	-
	-	LEDBA15D21WW	21	11-15	1.2	34 mm	35 mm	White
<b>Bayonet BA15S</b>	LEDBA15SU4CW	-	4 UB	8-30	1.2	27 mm	38 mm	-
	LEDBA15SS6CW	LEDBA15SS6WW	6 SB	8-30	1.3	27 mm	38 mm	-
	LEDBA15ST60CW	LEDBA15ST60WW	60	8-30	5	25 mm	67 mm	-
	LEDBA15ST30CW	LEDBA15ST30WW	30	8-30	3.6	25 mm	46.5 mm	-
	LEDBA15ST18CW	LEDBA15ST18WW	18 SB	8-30	3.6	22 mm	55 mm	-
<b>Single Contact</b>	-	-	-	-	-	-	-	-
	LEDBA15SF9CW	LEDBA15SF9WW	9 SB	8-30	2	40 sq	4 mm	-
	LEDBA15S42CW	-	42	11-15	2.5	25 mm	57 mm	-
-	LEDBA15S12SDCW	-	12	11-15	1	25 mm	42 mm	-
-	-	-	-	-	-	-	-	-
<b>T5</b>	LEDSGT53CW	-	3	8-18	0.3	5 mm	12 mm	-
<b>T10</b>	LEDST1010CW	-	10 SB	8-30	2	30 mm	40 mm	-
<b>T20 7440</b>	LEDST2018CW	-	18 SB	8-30	3.6	-	-	WEDGE-
	LEDF37S3CW	-	3 SB	10-30	1.3	10 mm w	37 mm	-
<b>FESTOON</b>	LEDF37S6CW	-	6 SB	10-30	1.5	16 mm w	37 mm	-
	LEDF42S9CW	LEDF42S9WW	9 SB	11-15	2	27 mm w	42 mm	-
<b>T5 TUBE</b>	LEDT5TUBE30CW	-	30 SB	11-15	-	15 mm	285 mm	Clear Tube

THIS IS JUST A SELECTION OF OUR LED BULBS. WE HAVE MANY NEW DESIGNS IN DEVELOPMENT  
SMD LED: More light intensity • Wider spread of the light • Low power consumption • Less shade sensitive light.

0844 414 2324

0844 414 2425

Lighting

Buy securely online at [Leisurelines.net](http://Leisurelines.net)



# SMARTLITE™ MODERN STYLISH LIGHTING RANGE



Lighting



**L70W** Diffused single 20w halogen midi lamp downlighter with switch (white) (1.6 amps) 12 volt  
215mm Long x 127mm W x 40mm High



**L9107** LAVA Lamp 8 watt fluorescent light.  
440mm long x 62mm wide x 27mm high. 12 volt with integrated large push switch.  
**L9107S** Silver 8w fluorescent



**L133** Slim light with 8w fluorescent tube, round mini rocker switch to end. 12v. Sizes L 390 x W 50 x H 33mm.  
**L133C** Chrome casing  
**L133W** White casing  
**L133SG** Silver grey casing  
190mmØ x 48mm high



Slim strip light with 1 x 8w fluorescent tube & rocker switch. Size L 385 x W 65 x H 27mm. White ABS casing PC diffuser.  
**L2908W** Slim rounded ends strip light



**LFR8862W** White. Bulb 3W  
**LFR8862LED** White. LED 1W

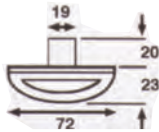

Slim dual strip light with 2 x 8w fluorescent tubes & 3 way switch, Size L 380 x W 65 x H 30mm. White ABS casing milky PS lens.  
**L2208DW** Slim dual strip light



Dual strip light with 2 x 8w fluorescent tubes & rocker switch. Size L 390 x W 85 x H 25mm. White ABS casing PC diffuser.  
**L2608DW** Rounded ends dual strip light



Dual square end strip light with 2 x 8w tubes & rocker switch. Size L 390 x W 85 x H 25mm. White ABS casing PC diffuser.  
**L2508DW** Square ended dual strip light.



Dome light 10w halogen 12v bulb with switch. Size 147mmØ x H 30mm.

**L609W** Dome light 10w Halogen white



**NEW LH687SS** 10W Halogen dome light Silver sand with switch  
150mm Ø x 34mm H



Round ceiling lamp 2 x 10w halogen bulbs 12v with switch. 200mm dia x H 55mm  
**L8720SC** CHROME



**L9515C** Compact mini dome light with circular 10w 12v fluorescent tube & 3w night-light, 3 way switch. Chromed ABS base with PP lens. Size 152mm Ø.



**L161** Multi light white ABS casing with 2 10w halogen swivel eyeball spots independently switched. 12 volt only.  
303mm Long x 110mm Wide x 40mm High  
**L161G** 2 X 10 w spots gold



**LED9CBLW** Mini LED cabin courtesy light with 9 bright white LED's. White casing with switch. Sizes L 170 x W 30 x H 38mm.



**LED42DMLD** Dome light with 42 white LED's, Polished brass casing with rocker switch.



Ceiling light silver sand with 36 super bright LED's Size L 150 x H 40mm  
**LED8899SS** With super bright LED's



**MDCS2009019** Automatic wardrobe light switch, fix to door aperture, light illuminates automatically on door being opened. Can be used with any 12volt light.



**L834** Automatic Cupboard light Nice oval styled slim profile push switch light. Mount on cupboard frame with door in contact with spring loaded push switch. As you open door light will come on. Turns off when door closed. Fitted 10w filament bulb. Size 105L x 85W x 40H. Colour: Brown.

## AUTOMATIC CUPBOARD LIGHT



**LFR8930W** White. Bulb G4 3W & Remote wired door contact switch.



**LH107** High quality flex stalk 10w halogen light. Frosted glass Tulip shade with brushed stainless base & flex stalk. Base with switch 60 mm Ø x 260mm Long stalk

## HIGH QUALITY AND RELIABILITY DULUX, PL & 2D LIGHTS

With comparable light output, fluorescent PL or 2D lights consume about 1/5 - 1/8 of the energy that a conventional light bulb would require. As a guide to lighting performance of these lights an 11watt dulux gives over 40 watts of light & a 16 watt 2D gives 75 watts of light output.

WE NOW OFFER INSTALLATION & REPAIR SERVICE BY [SupremeTech.co.uk](http://SupremeTech.co.uk)



Buy securely online at [Leisurelines.net](http://Leisurelines.net)



# HIGH SPECIFICATION GAS & CO WARNING ALARMS



Gas warning systems protect lives and health by monitoring the atmosphere inside any enclosed space and triggering optical & acoustic alarms, as soon as the concentration of the gas that is being monitored exceeds the preset threshold level. Our gas warning systems are based on semiconductor sensors that have proved themselves over many years of reliable operation. **KombiAlarm** is the ultimate in gas safety warning alarms.

## KOMBIALARM COMBINED GAS AND KO-GAS WARNING SYSTEM

The **KOMBIALARM** is a self-sufficient warning system with a built-in sensor and an audible and visual alarm-signalling unit. It is equipped with a specially designed sensor that enables the system to work as a **gas and KO-gas alarm system at the same time**. When gas is detected a loud buzzer sounds to deter intruders and wake the occupants.

Depending on the needs and size of the vehicle or vessel, the system is also available to connect two additional sensor units.

The additional sensors are available in two versions, one for the detection of gas (Propane, Butane & Methane) and Anaesthetic (KO) gases or Ether, sometimes called narcotic or "sleeping" gasses. The other sensor is for the detection of carbon monoxide or smoke. The additional sensors can be connected to either sensor output 2 or 3.

One additional switching relay allows the connection of remote alarm units (e.g. strobe flashlight). **KMBALSTL**

The **KOMBIALARM** detects even the smallest concentrations of KO-gas before it is able to display its intoxicating effect on the passengers and disables their ability to react. The threshold for butane, propane and methane lies well below the igniting point (when the concentration turns volatile) of the gas. Another special feature is the systems relatively low power consumption. After a short warm-up period the alarm is ready for use as the sensor threshold settings are fully automated. LED's indicate power ON, alarm and fault conditions. Operates on 12 Volt DC supply.

**Area of use: Boats, Caravans, Motorhomes, Holiday homes, Truck cabs**

## KOMBIALARM COMPACT MOTORHOME

The **KombiAlarm Compact**, our most popular unit, is designed for Caravans and Motorhomes and Truck cabs, where the installation of a one sensor unit is sufficient to detect gas and KO-gas. The unit is an easy to fit self-contained unit housed in a neat robust casing. Size H 90mm x W 115mm x D 30mm

**KMBCMP** KOMBIALARM COMPACT

## KOMBIALARM MULTI SENSOR MARINE

The **KombiAlarm** is designed for Marine use or the larger motorhome & caravan. It has all the functions of the compact with the facility to add, as and when required, an additional two sensor units (order separately) and a relay output for additional remote alarm units (e.g. strobe flashlight). Size H 90mm x W 115mm x D 30mm

**KMBALRM** KOMBIALARM MULTI SENSOR

**KMBALSTL** STROBE FLASHLIGHT

## ADDITIONAL SENSORS FOR KOMBIALARM MARINE

The use of additional sensors increases the early warning capability of the system. This is particularly suited to boats as Narrowboats can be 70 feet long with multiple rooms. Additional gas sensors can be mounted at low level to pick up gas leaks quicker and CO sensor high level for early indications of CO build up. Sensor sizes H/W/D 50x50x24 mm.

## SENSOR (Gas and KO-Gas) FOR KOMBIALARM MARINE

This sensor detects LPG, Propane, Butane and Methane Gas and Anaesthetic KO- Gas. This sensor can be used as second or third sensor unit. 3 m connection cable included (extendable).

**KMBALSG** KOMBIALARM EXTRA SENSOR GAS AND KO GAS

## SENSOR CO (Carbon monoxide and smoke) FOR KOMBIALARM MARINE

This sensor detects carbon monoxide (CO) the dangerous fumes produced by faulty or poorly serviced gas appliances. This sensor can be used as second or third sensor unit. 3 m connection cable included (extendable).

**KMBALSCO** KOMBIALARM EXTRA SENSOR CO

## GAS WARNING SYSTEM CAMP SIGNAL

The series **camp signal** model is a self-sufficient warning system that incorporates the sensor and the acoustic signalling unit in addition to the semiconductor based electronics. It is designed to work with a 12 Volt DC supply. Size 55 mm ø, Height 30 mm. **Area of use: Caravans, Motorhomes, Boats, Holiday homes**

**CMPSIGP** CAMP SIGNAL FOR MONITORING GAS

**CMPSIGC** CAMP SIGNAL FOR MONITORING CO

## CBE COMPACT GAS LEAK,

## ANAESTHETIC GAS & CARBON MONOXIDE DETECTORS

Latest electronic technology providing the utmost reliability and accuracy in a compact housing. The detectors provide peace of mind protection for the occupants.

The combined LPG and anaesthetic gas detector (**MTG/G**) has been specially developed to combat the threat of nighttime robbery, which is spreading in Europe. While parked at night anaesthetic gas is sprayed into vehicle vents allowing access for theft without you knowing until you awake. This is particularly prevalent in southern Europe and France.

The carbon monoxide detector (**MTCO/G**) will warn of faulty flued or poor burning quality gas appliances, particularly useful if heaters are left on at night.



**MTG/G**  
Gas leak detector for LPG and anaesthetic gas 12V



**MTCO/G**  
Carbon monoxide detector 12V



**KMBCMP** KOMBIALARM COMPACT



**KMBALRM** KOMBIALARM MULTI SENSOR MARINE

### **Specifications of KombiAlarm**

Operating Voltage	12 Volts DC
Consumption Standby	90 mA
Consumption Alarm	145 mA
Consumption extra sensor	60 mA
Electronic siren loudness	85 dB (A) / 3 m

### **Sensor Thresholds Gas**

Butane	0.4%
Propane	0.5%
Methane	0.8%

### **Sensor Thresholds KO gas**

Anaesthetic	100 ppm
-------------	---------



**KMBALSG**



**CAMP SIGNAL CO**

## NEW INOVTECH Pro-Gaz GAS DETECTOR.

A complete solution, easy to install. Detects carbon monoxide, narcotic gas & gas leakages. High power sound and visual alarm. The kit includes: the management unit with test function and On/Off button, two wire-linked gas detectors (5m long linking cables), a wall-mounting kit with screws and two warning stickers. Operates at 12/24v DC 70 consumes just 0.3Amp. Size (WxHxD); management unit 108x94x45 mm, Sensor 82x 49x 35 mm. Order Code. **KMBPROGAZ**



**Gas leakage and carbon monoxide detector**

**Narcotics gas detector**



## WAECO MagicSafe DMSG 150 Gas detector 12 and 24 volts

How do you know if gas from an on-board supply has leaked into your vehicle? Probably only when it is too late ... The **WAECO MagicSafe MSG 150** gas detector protects you. It reliably detects the presence of narcotic gases in the atmosphere and immediately triggers the alarm: the integrated buzzer emits an audible signal and the red LED flashes. Simultaneously, the output relay is switched on. It can be used to activate external alarm units up to 10 A. You can silence the audible alarm by pressing a button. The same button can be used to start the sensor's function test. Detects all common narcotic gases based on ether, chloroform, butane, ethane and trichlorethene. It automatically adjusts to the room atmosphere. Can be fitted as a stand-alone device or in combination with the MagicSafe MS 650, MS 660 and MS 670 alarm systems. Audible and visual alarm signals, Self-cleaning gas sensor

**DMSG-150**



**DMSG150 WAECO MagicSafe Gas detector**

WE NOW OFFER INSTALLATION SERVICE BY **SupremeTech.co.uk**



**0844 414 2324**



**0844 414 2425**

**240V Consumer unit to be ordered separately depending on the model required**

## C 860 CONTROL SYSTEM SOLD ONLY AS KITS

C860 control panel with led indicators has the following functions: battery 1 - battery 2 levels led display, fresh and waste tank levels, 12 volt master switch, pump switch & two lighting switches, fridge relay, split charge relay. All switches have blade fuse circuit protection. Red, white & black multi-way plugs supplied for customer to wire in their own wiring harness. Control panel dimensions 308mm x 98mm.

Order Code **C860**. The kit comprises of the following items.

<b>C860</b>	ANALOGUE LED CONTROL PANEL WITH FUSES
<b>CHCB510</b>	SWITCHING BATTERY CHARGER.
<b>CSB40-S</b>	AUTOMATIC BATTERY SEPARATOR WITH FUSES FOR FRIDGE, BATTERY & EQUIPMENT.
<b>SP5/40</b>	LEVEL PROBES FRESH TANK 400mm (can be cut to size).
<b>SSP</b>	STUDS FOR HIGH LEVEL WASTE GAUGE.
<b>CCS860</b>	CABLE LEVEL INDICATORS L = 6m



**C860**

## PC100 CONTROL SYSTEM SOLD ONLY AS KITS

PC100 microprocessor control panel with LED display has the following features, voltage levels battery 1 - battery 2, fresh & waste water tank levels, switches for pump, lighting and fridge. Battery recharge control, low voltage remote control of functions at panel which are switched at distribution board. This reduces the spaghetti of wiring normally going all the way to the control panel. Now only the control wire runs from panel to distribution box. Panel dimensions 192mm x 78mm. DS-300 distribution box 180x150x85mm.

Order code **PC100**. The kit comprises of the following items.

<b>PC100</b>	ANALOGUE LED CONTROL PANEL
<b>CB510</b>	SWITCH MODE BATTERY CHARGER
<b>DS 300</b>	12V DISTRIBUTION CONTROL BOX WITH 9 FUSED CIRCUITS.
<b>SP5/400.</b>	LEVEL PROBES FOR FRESH TANK.
<b>SSP</b>	STUDS FOR HIGH LEVEL WASTE GAUGE.
<b>CCS910</b>	CABLE LEVEL INDICATORS L = 6m
<b>CP973-6</b>	CABLE CONTROL PANEL L = 6m



**PC100**

## PC 200 CONTROL SYSTEM SOLD ONLY AS KITS

PC200 microprocessor control panel with LCD display has the following features, voltage battery 1 - battery 2 in volts, power consumption if activated, tank levels in percentage, internal and external temperature, switches for pump, lighting and fridge. Battery recharge control, low voltage remote control of functions at panel which are switched at distribution board. This reduces the spaghetti of wiring normally going all the way to the control panel. Now only the control wire runs from panel to distribution box. Panel dimensions 192mm x 78mm. DS-300 distribution box 180x150x85mm.

**Must be ordered separately to size required SPE/... LEVEL PROBE FRESH TANK. (PAGE 91)**

Order code **PC200**. The kit comprises of the following items.

<b>PC200</b>	DIGITAL CONTROL PANEL WITH LCD DISPLAY
<b>CB516</b>	SWITCH MODE BATTERY CHARGER
<b>DS 300</b>	12V DISTRIBUTION CONTROL BOX WITH 9 FUSED CIRCUITS.
<b>SSP</b>	STUDS FOR HIGH LEVEL WASTE GAUGE.
<b>CCS200</b>	CABLE LEVEL INDICATORS L = 6m
<b>CP973-6</b>	CABLE CONTROL PANEL L = 6m
<b>CTIE</b>	CABLE TEMPERATURE SENSORS INTERNAL & EXTERNAL



**PC200**

## NEW PC220 CONTROL SYSTEM SOLD ONLY AS KITS

PC220 control panel is a Microprocessor controlled system with a 7 colour graphic LCD screen, has the followings functions: digital clock, vehicle battery test (volt and graphic), Leisure battery (volt and graphic), drinking water tank level (percentage and graphic), internal and external temperature test, Electronic battery separator, fridge control, protection fuses, vehicle battery recharging control, Leisure battery low voltage protection function. Control panel dimensions 181 x 131 mm. DS-300 distribution box 180x150x85mm.

**Must be ordered separately to size required SPE/... LEVEL PROBE FRESH TANK. (PAGE 91)**

Order code **PC220**. The kit comprises of the following items.

<b>PC220</b>	DIGITAL CONTROL PANEL WITH LCD DISPLAY
<b>CB510</b>	SWITCH MODE BATTERY CHARGER
<b>DS 300</b>	12V DISTRIBUTION CONTROL BOX WITH 9 FUSED CIRCUITS.
<b>SSP</b>	STUDS FOR HIGH LEVEL WASTE GAUGE.
<b>CCS200</b>	CABLE LEVEL INDICATORS L = 6m
<b>CP973-6</b>	CABLE CONTROL PANEL L = 6m
<b>CTIE</b>	CABLE TEMPERATURE SENSORS INTERNAL & EXTERNAL



**PC220**

## CBE SWITCH MODE BATTERY CHARGERS

are specifically designed for the motorhome, caravan and boating sectors. The battery charger can remain connected or be continuously on, as it automatically chooses the charging needs of the battery.

**CB500 series.**

The high frequency switching technology provides higher performance levels as well as a reduced weight and size.

The switching battery charger can automatically charge 12v batteries (lead-acid, AGM or gel). The battery charger is protected against overheating and the 12 V outputs are protected against possible short circuits and polarity reversal.

The charging process "IUoU" takes place in four stages:

- 1) Battery charging with maximum current until the end-charge voltage is reached.
- NOTE: the end-charge voltage can only be reached if the battery is fully efficient.
- 2) When the end-charge threshold is reached the battery charger continues to operate for 90 minutes (lead-acid batteries) or 8 hours (lead-gel batteries) with constant voltage.
- 3) Constant voltage holding at 13.8 V (gel batteries) or 13.5 V (lead acid batteries.).
- 4) After 10 hours, the battery charger switches to the Stand-by mode and begins to charge again only when the battery voltage is lower than 13 V.



**NEW CB500 series switch mode chargers 10 > 22 amp.**

- CHCB510** 10 Amp CB500 charger 12v
- CHCB516** 16 Amp CB500 charger 12v
- CHCB522** 22 Amp CB500 charger 12v
- CHCB51624** 8 Amp CB500 charger 24v

## DSSR

This DIN module is added to the DS-120S mains consumer unit to automatically switch from mains hook up plug to generator or vice versa to prevent electrical damage 240 20Amp

**DSSR** Auto mains power change over switch



**DS-SR**

**WE NOW OFFER INSTALLATION AND SAFETY INSPECTION SERVICE BY [SupremeTech.co.uk](http://SupremeTech.co.uk)**



## CBE BERKER MODULAR PLATES

For neat, simple & stylish installation of switches, mains outlet sockets, TV, satellite, 12 volt and other electrical accessories. The CBE Berker modular plates system uses a BMAC CORNICE to install control module, and to hide the fixings. The modules cannot be installed without the use a BMAC cornice.



**BMAC1/GR BERKER**  
1 MODULE COVER  
FRAME

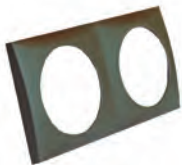

**BMAC2/GR BERKER**  
2 MODULE COVER  
FRAME



**BMAC3/GR BERKER**  
3 MODULE COVER  
FRAME

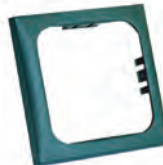

**BMAC1C/GR CBE**  
BERKER 1 MODULE  
CONVERTER  
FRAME



**BMAC2C/GR CBE**  
BERKER 2 MODULE  
CONVERTER  
FRAME



**BMAC3C/GR CBE**  
BERKER 3 MODULE  
CONVERTER  
FRAME



**BMAD/GR BERKER**  
GREY SPACER PLINTH



**BMADG/GR BERKER**  
SURFACE MOUNT BOX 1  
GANG



**BMAP/GR BERKER**  
FRAME WITH HINGED  
COVER



**BMP22B/GR BERKER UK**  
3PIN MAINS SOCKET  
GREY



**BMPUSB/GR BERKER**  
USB 5V 1A CHARGING  
SOCKET GREY (INPUT  
VOLTAGE 12V)



**BMAS50/GR BERKER**  
BACK PROTEC BOX  
50DIA X 40MM



**BMC12/GR BERKER**  
SINGLE ON OFF SWITCH  
+ LED



**BMC2N/GR BERKER**  
TWIN ON OFF SWITCH  
GREY



**BMCD/GR TWO WAY**  
SWITCH GREY



**BMCG5/GR BERKER**  
SINGLE SWITCH  
ELECTRIC STEP IN OFF  
OUT



**BMCN/GR BERKER**  
SINGLE ON OFF SWITCH  
GREY



**BMCP/GR BERKER**  
PUSH BUTTON SWITCH  
GREY



**BMCR/GR BERKER**  
ELECTRONIC DIMMER  
SWITCH 12V 60 WATTS



**BMP/GR**  
BERKER GREY  
BLANKING PLATE



**BMP12A/GR BERKER**  
12V DC GREY AUTO  
SOCKET



**EA12RC4 4WAY**  
REMOTE CONTROL BOX  
& FOB 12V



TV F connector pack 10  
**MCAP5** 5mm cable  
**MCAP6** 6mm cable  
**MCAP7** 7mm cable



**BMPRCE3/GR BERKER**  
RCA 3 DVD SOCKETS

## CBE MAINS 240V CONSUMER UNIT

A mains consumer unit is an important part of your electrical system. It protects your vehicle and occupants from electric shock hazards when connected to the site hook-up. No output plugs with unit requires DS120 plugset. The DS120-S is a RCD main switch with a double pole 13amp MCB to control and protect the various mains electrical items installed.

**DS120-S** Mains Consumer Unit ELCB, RCD & double pole 13A MCB  
**DS120PLUGSET** Connecting plug set for output wiring.



**DS120-S**

## CBE SWITCH MODE BATTERY CHARGERS

A2000 series

The high specification switch mode technology provides high performance and large charging outputs.

The "IUoU" charging line recharges the battery in three phases:

- 1) Maximum charge: at the maximum current, electronically moderated, reaches up to 14.4 V (25°C).
- 2) End of charge: at 14.4 V (25°C) continuous for a time of: 1h (Lead-acid), 6h 20' (Gel)
- 2) Maintenance: at 13.8 V (25°C) continuous, until the connection of a load.

A2000 models are equipped with a battery temperature sensor connection, which allows charger to adjust the output voltage and therefore, extend the battery's life.



**A2000** series switch mode battery chargers 18 > 35 amp 12v, with optional battery temperature sensor for charge control. **A2035** 35Amp , **A2018** 18 Amp,

CSTB Battery temperature sensor for A2000 series chargers.

WE NOW OFFER INSTALLATION AND SAFETY INSPECTION SERVICE BY [SupremeTech.co.uk](http://SupremeTech.co.uk)



0844 414 2324



0844 414 2425



# CBE ELECTRICAL EQUIPMENT



## CBE MODULAR PLATES

For neat, simple & stylish installation of switches, mains outlet sockets, TV, satellite, 12 volt and other electrical accessories. The CBE modular plates system uses a **MAT** frame to install control module, and a **MAC** cornice to hide the fixings. Add colour code to end of MAC product code for coloured cornices. Standard **MAT** frame colour /G =DARK GREY RAL 7015



**MAC1NL/G** 1 MODULE CORNICE  
**MAT1NL/G** 1 MODULE FRAME



**MAC2NL/G** 2 MODULE CORNICE  
**MAT2NL/G** 2 MODULE FRAME



**MAC3NL/G** 3 MODULE CORNICE  
**MAT3NL/G** 3 MODULE FRAME



**MPUSB/G** 12V INPUT USB SOCKET



**MP22B/G** UK 3pin mains socket includes back box.

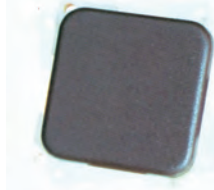

**MCN/G** Single on off switch 12V 240v If used with back box MAS..



**MC2N/G** Twin on off switch

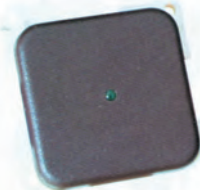

**MC12P/G** Single on off switch with led indicator



**MCG5/G** Single momentary 3 way on-off-on switch.



**MC12N/G** Single on off switch with 12v LED indicator



**MCD1N/G** Single on off switch



**MCD2N/G** Twin on off switch



**MCGD5/G** Twin switch for electric step & awning light.



**MCD/G** Two way modular switch  
**MCP/G** Single push button modular switch.



**MTB/G** Battery level led test gauge 12v

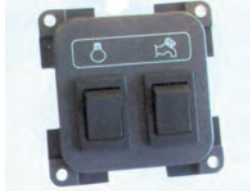

**MCPL/G** Pump and lights control switch panel grey



**MCNF/G** Water heater mains element switch with 5A + spare fuse includes back box.



**MPF4/G** 4 blade fuse module



**MCB** Buzzer and LED module for step open warning circuit

These four modules can be combined to produce a main control panel of essential equipment for the smaller conversion.



**MP12ATV/G** 12 V auto socket + TV outlet ( 9,5 75 Ohm)  
**MP12ATVS/G** 12 V socket auto type + TV + satellite outlet ( F 75 Ohm) matching 12 V plugs see page 92



**MCR/G** Electronic dimmer switch 12v 3 amp for halogen lights or fans.



**MPCRA3TVS/G** 3 X RCA with Sat & TV connectors



**MPTV/G** TV OUTLET (9,5 75 Ohm) GREY  
**MPTVS/G** TV outlet + satellite outlet (F 75 Ohm) grey



**MP12/G** 12 VOLT DC DIN SOCKET  
**MP12TV/G** 12 V DIN socket + TV outlet ( 9,5 75 Ohm)  
**MP12TVS/G** 12 V DIN socket + TV + satellite outlet ( F 75 Ohm) matching 12 V plugs see page 92

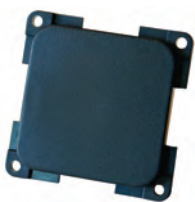

**MP/G** Blank plate.



**MPCRA6/G** 6 x RCA connector for DVD and satellite installation.



**MP12AC/G** 12 V socket auto type with hinged cover.



**MP12A** 12 V socket auto type.



**MP12ACS** 12 V socket auto type with splash proof cover.

**MPEXBOXW** Flush fitting external one module box. Designed for any CBE modules to be installed Colour: white (see page 95)

**WE NOW OFFER INSTALLATION AND SAFETY INSPECTION SERVICE BY [SupremeTech.co.uk](http://SupremeTech.co.uk)**





## CBE MODULAR PLATES

For neat, simple & stylish installation of switches, mains outlet sockets, TV, satellite, 12 volt and other electrical accessories. The modular plates system uses a MAT frame to install control module, and a MAC cornice to hide the fixings. The modules cannot be installed without the use of MAT frame and MAC cornice. Add colour code to end of MAC product code for coloured cornices. Standard MAT frame colour /G = DARK GREY see page 80.

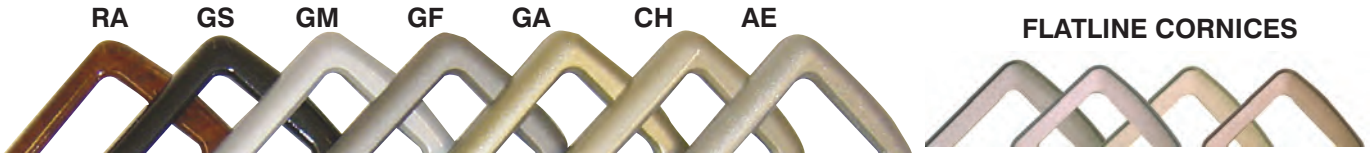

1 MODULE CORNICE		2 MODULE CORNICE		3 MODULE CORNICE		FLATLINE CORNICES
MAC1NL/AE	Textured metallic silver	MAC2NL/AE	Textured Metallic Silver	MAC3NL/AE	Textured metallic silver	FLATLINE CORNICES BS = NICKEL PE= SILVER
MAC1NL/CH	Champagne gloss	MAC2NL/CH	Champagne gloss	MAC3NL/CH	Champagne gloss	
MAC1NL/GA	Silversand satin RAL 9007	MAC2NL/GA	Silversand satin RAL 9007	MAC3NL/GA	Silversand satin RAL 9007	
MAC1NL/GF	Iron grey matt	MAC2NL/GF	Iron grey matt	MAC3NL/GF	Iron grey matt	MAC1-FL/BS or PE MAC2-FL/BS or PE MAC3-FL/BS or PE
MAC1NL/GM	Metallic light grey gloss	MAC2NL/GM	Metallic light grey gloss	MAC3NL/GM	Metallic light grey gloss	
MAC1NL/GS	Metallic charcoal gloss	MAC2NL/GS	Metallic charcoal gloss	MAC3NL/GS	Metallic charcoal gloss	
MAC1NL/RA	Walnut effect gloss	MAC2NL/RA	Walnut effect gloss	MAC3NL/RA	Walnut effect gloss	



**MAS45** back box 45mm ø 48mm deep + cable grip  
**MAS50** back box 50mm ø 34mm deep + cable grip  
**MAD/G** 10mm Distance ring 60x60x10  
**MAC1P/G** single snap on frame 60x60mm for use with **MAD**  
**MAC2P/G** Twin snap on frame 113x60mm



**MPC258** DOUBLE SATELLITE MODULE  
**MP22D/G** 230V SCHUKO CONTINENTAL SOCKET & COVER  
**MPC251** FRAME WITH COVER  
**MPC298** SURFACE BACK BOX  
**R550-U** 12v Input Inline 5V 1A USB charger Cable L=1,5m



**R550-M** 5V 2A charger with multi-jack l=1,5m  
**R550-MU** 5V 2A mini USB charger l=1,5m  
**R555/2** Adapter 12V universal angled plug/ pin 2,1x5,5 (8A)  
**R555/8** Adapter 12V universal straight plug/ pin 2,1x5,5 (8A)  
**R417-R** Adapter 12V DIN plug / 12V cigarette lighter socket

**DLS-200 Dimmer - light brightness adjuster**  
 The light brightness adjuster DLS-200 is an electronic device which allows the brightness of the motorhome's internal lights to be varied (resistive incandescent, LED and halogen lights). It can be connected to one or more push buttons installed in the vehicle. By pressing once, lights can be switched on and off while continual pressing varies the light's brightness. The DLS-200 can manage up to 8 different light channels up to 200W maximum power.  
**Technical specs**  
 Power supply / nominal voltage: 12Vcc, Maximum power: 200W, Up to 8 dimmed light channels (parallelable), PWM (pulse-width modulation) outputs, Short-circuit and overheating protection, Dimensions (mm): 102 x 60 x 30 h, Weight: 100g.

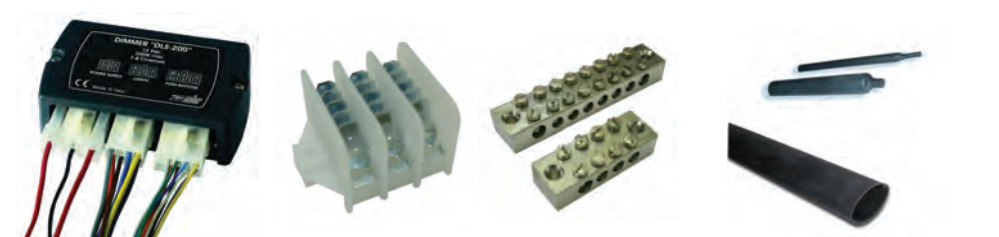

**ETB3x5** Multi spade isolated distribution connector block. Provides 3way x 5 connectors  
 Earth terminal block Nickel plated brass  
**ETB4** Earth Block 4way  
**ETB8** Earth Block 8way  
**EHS5164** Heat shrink tubing 6.4mm un-shrunk black polyolefin Pack contains 5 x 1mtr lengths.

WE NOW OFFER INSTALLATION AND SAFETY INSPECTION SERVICE BY [SupremeTech.co.uk](http://SupremeTech.co.uk)



Buy securely online at [Leisurelines.net](http://Leisurelines.net)

## SOLAR CHARGE REGULATORS

Developed to control the charging of 12v batteries by Photovoltaic (solar) panels. They are produced with built in diodes to aid easy connection. Built in charge and warning LED's depending on model. The **SPRS240** is designed to connect to the optional digital charge amp and battery state voltage test panel **PT542**. All regulators are 12 volt, control in series with Mosfet, built in Schottky diode, and reverse polarity protected. Final charge regulation 14.4 / 13.8 volts.

Model	SPRS110	SPRS240
Continuous power draw	0,01 mA @ 12 V	0,01 mA @ 12 V
Maximum connected wattage	110 W	2 x 120 W
Max Voltage	14.1	14.3 Gel 14.1 Lead Acid
Maintenance voltage	13.5	13.8 Gel 13.5 Lead Acid
Reverse polarity protection	YES	YES
Internal fuse	NO	20 A
Ready to connect PT542	NO	YES
No of panels connectable	ONE	TWO
Battery type selector	NO	YES
Dimensions ( mm )	115x90xH37	115x90xH37



SPRS240

SPRS120



**PT542** test panel to check solar panel performance, charging amps and battery voltage. Connects to **SPRS240**. Cable length 1.5M. Panel colour grey, size 60x60mm. ALSO FITS INTO CBE MODULAR PLATES

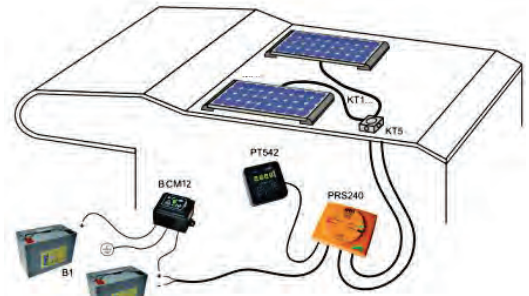

## PHOTOVOLTAIC SOLAR PANELS ONLY. (SPW...)

High specification solar panels, latest technology for the highest efficiency, give a charge output even in low light overcast periods. Anodised Aluminium outer panel frame.

We have a selection of panel sizes and wattage's available. See Price list for more information

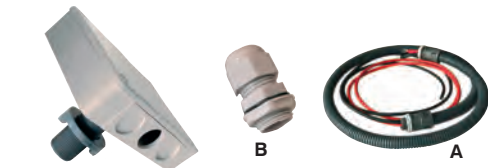

**SPKT5** through roof waterproof cable connection with up to six entries. Allows additional wires from reversing camera or TV / satellite cables in addition to two solar panels. Choice of solar panel cables below connect to it. Or use **SPKT5RP** to connect other cables.

- SPKT5C10** 2M OF 6mm2 CABLE WITH 1M OF FLEXIBLE CONDUIT
- SPKT5C20** 3M OF 6mm2 CABLE WITH 2M OF FLEXIBLE CONDUIT
- SPKT5RP** CABLE GLAND FOR SPKT5

## FIXING SUPPORT FOR SOLAR PANELS

Anodised aluminium fixing brackets with aerodynamic over covers. Allows panel installation on any surface. Designed for campers with easy installation by Sikaflex Adhesive sealant and stainless safety screws. See Price list for order codes (**SPSA...**) and panel dimensions.

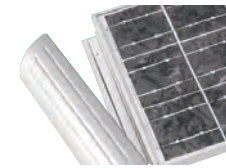

## SOLAR PANELS WITH REGULATOR AND INSTALLATION KIT

First quality Mono crystalline solar panels, offering high energy performance. Panels are supplied with aerodynamic end fixing profiles. Profiles are grooved to allow direct bonding with the supplied adhesive kit. Pre mounted and prewired with UV resistant 2 x 4mm2 cable 8 m long. Water tight Aerodynamic cable entry glands Included. Supplied with regulator and tube of adhesive for 2 panels. Packed in sets of 2 panels

- 75 watts L 1192 x W 541 x H 47
- 100 watts L 1390 x W 600 x H 47
- 120 watts L 1455 x W 670 x H 47
- 150 watts L 1680 x W 670 x H 47

- SPWKIT752** 2 x 75w panels kit
- SPWKIT1002** 2 x 100w panels kit
- SPWKIT1202** 2 x 120w panels kit
- SPWKIT1502** 2 x 150w panels kit



**CAK Battery Charge Manager BCM12.** Automatic charge switching device allows charging of the vehicle starting battery once the auxiliary battery is charged by hook-up charger or solar panel. Charge rate 0.1 to 4 A max. Allows better use of wasted solar panel charge by directing it to a second battery prevents flattening of start battery from having cab equipment running. LED illuminates to confirm unit has switched to charge. Size 80x50xD50mm



## DC TO DC VOLTAGE CONVERTERS. 24 VDC TO 12 VDC

The PowerVerter range of switch mode voltage converters offers a convenient & reliable way to install 12Vdc equipment on 24Vdc on vehicles, vessels & aircraft. Switch Mode technology enables high efficiency (up to 93%) ensuring low heat dissipation, Compact, light weight, rugged & splash proof - sealed to IP53. Click & fit three point mounting bracket ensures quick & secure installation. Red output LED indicates correct operation & eases fault finding. Inherent reliability, CE & E marked. Surface mount technology (SMT) based assembly techniques assure resistance against shock & vibration. Recessed push-on terminals reduce the risk of lost connections due to vibration. Conservatively rated and suitable for mounting in confined spaces without over heating. Full circuit protection (transient, overheat, overload & catastrophic failure). Meets the VIDG5/AES specification for use on emergency services vehicles.

- PV3** Continuous load 3 Amp Intermittent Load 6 Amp
- PV6** Continuous load 6 Amp Intermittent Load 10 Amp

## Dometic Perfect Power DCDC20 & DCDC40

Voltage converters suitable for sensitive applications. Ideal for larger motorhomes with 24 volt starter battery and 12 volt Leisure battery. Suitable for split charging with IU battery charging curve. Electrically isolated & clean output voltage. To increase capacity parallel operation of several converters is possible, additional ON/OFF input, stabilises the battery / generator voltage.

- DDC241220** 20 amp 24 volts to 12 volts
- DDC241240** 40 amp 24 volts to 12 volts

DDC241220



DDC241240



PV6

	DCDC20	DCDC40
Nominal input voltage	24 volts DC	24 volts DC
Input voltage range	20 to 32 volts DC	20 to 32 volts DC
Output current	20 A	40 A
Output voltage	13.8 ± 0.1 volts	13.8 ± 0.1 volts
Energy efficiency	87%	87%
Ripple & Noise	20 mA	20 mA
Dimensions (W x H x D)	115 x 70 x 140mm	115 x 70 x 240mm
Weight	1.0 kg	1.9 kg
Test mark	e-approved to Automotive EMC Directive	

WE NOW OFFER INSTALLATION AND REPAIR SERVICE BY [SupremeTech.co.uk](http://SupremeTech.co.uk)



# CBE CONTROL PANELS & WATER LEVEL INDICATORS



**Volts**



**°C**



**Volts/amps**

**PT532** Digital battery voltage gauge. Microprocessor controlled displays voltage from battery 1 and 2 on digital display. Panel colour grey, size 60x60mm.

**PT538** Digital internal and external temperature gauge. Microprocessor controlled, complete with sensors, sensor cable length: internal 0.5m, external 3m. Colour grey, size 60x60mm.

**PT552** Digital battery voltage and consumption gauge. Provides a reading for battery voltage and displays battery consumption or charge in amps on the range of -130 to + 130 Amps. Complete with shunt and 5m of cable. Panel colour grey, size 60x60mm.

## C.A.K. WATER CHECK™ (PICTURE A)

Water check™ side mounted level switch kit with remote indicator light panel. Provides high (waste) or low (fresh) level warning. We can fit sensor to new build tanks at time of production, or simple diy retro-fit to existing plastic or metal tanks. Not suitable for use in toilet tanks. Can be used on 12 or 24 volt systems. New version now fits CBE modular plates range see page 88-89.

- WLIF** 12V / 24V Fresh water check™ 1/4 full indicator light
- WLIW** 12V / 24V Waste water check™ 3/4 full indicator light
- MPWLIW** 12V / 24V Fresh water check™ 1/4 full indicator light Modular plate
- MPWLIW** 12V / 24V Waste water check™ 3/4 full indicator light Modular plate
- WLIS** Spare tank sensor for above kits
- WLISB** Spare indicator light for above kits

## C.A.K. LEVEL CHECK™ (PICTURE B)

The C.A.K. Level check™ multi level indicator™. Side mounted contacts provide indication of 5 levels to panel display. Will fit similar panel cutout to replace older gauges with needle displays. We can install stainless contacts on new build tanks, otherwise both versions are easily retrofitted to existing plastic tanks. Not to be fitted in metal tanks

- LCF** 12V Fresh level check™ multi level indicator kit (12 volt only)

## C.A.K. FILL CHECK™ (PICTURE C)

The C.A.K. fillcheck™ multi level indicator™ has been developed to provide a visible indication of two levels. Panel has push test button, green OK light and amber and red level warning lights. Provides high level warnings suitable for waste and toilet holding tanks and certain chemicals. Stainless contacts can be installed to suit required warning levels. Not to be fitted in metal tanks.

- FCLIW** 12V Fill check™ twin level indicator (12 volt only)

## CBE ELECTRONICS WATER AND WASTE LEVEL GAUGES

Designed to match the CBE electronics range of modular plates and control panels (see pages 86-89), the gauges are of a high quality and specification.

### CBE DIGITAL WATER AND WASTE LEVEL GAUGE

**PT522** digital water level gauge, microprocessor controlled showing levels of fresh and waste tank as a % on digital read out. The two **SPE/...** Electronic tank sensors must be ordered separately depending on depth of the fresh and waste water tanks. The unit can be operated with only one **SPE/...** sensor if you only have one of the tanks, the second sensor can be added with the other tank later. **SPE/...** sensor cannot be cut down to size, as this will damage the special coating on the sensor, preventing it functioning correctly. The **SPE/...** sensors are installed into the top surface of the tank. Length of sensor to panel connecting cables 4mtr, Panel colour grey, Overall size 143x78mm. Not for fitting in metal tanks. (12 volt only)

- PT522** CBE digital water and waste level gauge 12 volt
- SPE/100** 100mm electronic tank sensor
- SPE/200** 200mm electronic tank sensor
- SPE/300** 300mm electronic tank sensor
- SPE/400** 400mm electronic tank sensor
- SPE513036** 360mm electronic tank sensor with overflow and pump out dip tube to base.
- SPE/160** 160mm electronic tank sensor
- SPE/250** 250mm electronic tank sensor
- SPE/330** 330mm electronic tank sensor
- SPE/440** 440mm electronic tank sensor

### CBE COMBINED FRESH AND WASTE WATER TANK GAUGE

**MT214/G** twin water gauge provides fresh & waste levels with LED display. A single red LED warns of the waste tank filling up and four different coloured LED's identify 4 levels in the fresh tank. The gauge comes complete with 4 metres of cable, a pair of stud sensors for the waste tank and a SP5/40 fresh water tank sensor this sensor can be shortened to suit tank depth. Fresh sensor is OK for use in metal tanks. Waste studs not to be fitted in metal tanks (12 volt DC only). Panel colour grey matches up to CBE modular plates system (Page 88-89)

- MT214/G** CBE combined led fresh and waste tank gauge

### CBE INDIVIDUAL FRESH WATER TANK GAUGE

**MTT/G** water gauge provides fresh levels with LED display. Four different coloured LED's identify 4 levels in the fresh tank. The gauge comes complete with 4 metres of cable and a SP5/40 water tank sensor this sensor can be shortened to suit tank depth. OK for fitting in metal tanks (12 volt DC only). Panel colour grey matches up to CBE modular plates system (Page 88 - 89)

- MTT/G** CBE individual LED fresh tank gauge

### CBE INDIVIDUAL WASTE WATER TANK GAUGE

**MTTR/G** water gauge provides waste levels with LED display. Four different coloured LED's identify 4 levels in the waste tank. The gauge comes complete with 4 metres of cable and a SP5/40 water tank sensor this sensor can be shortened to suit tank depth. OK for fitting in metal tanks (12 volt DC only). Panel colour grey matches up to CBE modular plates system (Page 88 - 89)

- MTTR/G** CBE individual LED waste tank gauge

### CBE SP5 SENSORS

- SP5/50** 500mm 4 Rod tank sensor
- SP5/70** 700mm 4 Rod tank sensor

### NEW WATER LEAK ALARM - WLA3

Place the 3 sensors in areas of possible water leakage and wire back to control unit. If a water leak is detected alarm will sound and unit will switch off the pump to prevent further damage. Minimal power consumption 0.01mA 12v



**A**



**B**



**C**



**PT522**



**MT214/G**



**MTT/G**



**MTTR/G**

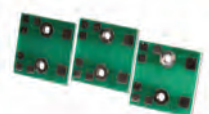

**WLA3**

Electrical

Buy securely online at [Leisurelines.net](http://Leisurelines.net)

WE NOW OFFER INSTALLATION SERVICE IN KENILWORTH BY [SupremeTech.co.uk](http://SupremeTech.co.uk)



0844 414 2324



0844 414 2425



# ELECTRICAL ACCESSORIES



Electrical



Fits 20mm hole 10A@12V  
**MRS132RD** RED SPOT  
**MRS411AM** AMBER SPOT  
**MRS412BL** BLUE SPOT  
**MRS413GR** GREEN SPOT

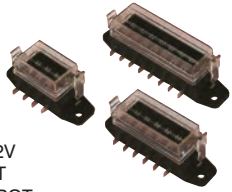

**FUSE BOXES** Neat range of multi way blade fuse blocks supplied empty. Full range of blade fuses available see below for codes.  
**BFH2** 2 way  
**BFH4** 4 way  
**BFH6** 6 way  
**BFH8** 8 way  
**BFH10** 10 way  
**BFH12** 12 way

## RESETTABLE BLADE FUSE TRIPS



Miniaturised single pole circuit breaker designed to replace normal automotive blade fuses. Reset button pops up showing clearly which circuit has a fault, simply press-to-reset. Ratings are 6, 8, 10, 15, 20 and 25 amps.  
**BFRST6,8,10,15,20,25**



**R450** 50 amp battery fuse  
**R450FUSE** Spare 50 amp fuse link



**R421** Encased fuseholder with 10A blade fuse (max 25A)



**R420** Inline blade fuseholder with 10A blade fuse (max 25A)



**R420-S** Wired inline blade fuse holder with cap & 10A blade fuse



12 V straight DIN plug  
**R412** Standard DIN Plug  
**R412N** Economy DIN Plug



**R419L** 12 V straight universal Cigarette & DIN plug built in 8A fuse + led indicator



**R419F** 12 V straight universal Cigarette & DIN plug built in 5A fuse



**R419/90** 12 V 90 degree universal Cigarette & DIN plug built in led indicator



**EAD11** Universal Cigarette & DIN plug with built in On-Off switch and 8A fuse. For 12 or 24v use



**R513** 12 V wall surface mount DIN socket with cover



**R512** Thru wall DIN socket with back nut and cover 16A@12V



**R532** Triple recessed wall mounted DIN socket set.



**R511/V** Inline DIN socket



**EAD403** Edison 2-Pin D.C. plug. 2 flat pins one wider than the other fits most caravans. Similar to Clipsal type plug.



**R712** Recessed auto socket 10A



**R713** Recessed or surface mounted auto socket. The recessed module is clipped inside the surface box. Easily separated.



**R510/2** Inline Auto socket with 1.8mtr cable



**R417** Adaptor 12v DIN plug / 12v auto socket



**EAD122** Twin surface mounted auto sockets with water resistant covers



**EAD510** Inline auto socket



**NEW RRS3PK** on-off-on change over rocker switch



**R417-R** Adapter 12V DIN plug / 12V cigarette lighter socket



**EBCC25** Battery crocodile clip 25 Amp with nut & screw connection



**BLF....** 5 pack of blade fuses 30, 25, 20, 15, 10 & 7.5 amp

WE NOW OFFER INSTALLATION AND SAFETY INSPECTION SERVICE BY [SupremeTech.co.uk](http://SupremeTech.co.uk)

Buy securely online at [Leisurelines.net](http://Leisurelines.net)



## ELECTRICAL CABLE

Flexible multi-stranded single core PVC auto cable. Manufactured to BS6862 part 1 1971. Suitable up to temperatures of 70°C. Resistant to petrol, diesel, lubricating oils & diluted acids. Amps are the continuous current rating of cable.

**SINGLE CORE** Add PM to end of code to buy cable by the metre.

Code	Colour	X section	Amps	Conductor Spec	Qty m
EC105K	BLACK	0.65mm <sup>2</sup>	5	9/0.30mm	50
EC105R	RED	0.65mm <sup>2</sup>	5	9/0.30mm	50
EC108K	BLACK	1.0mm <sup>2</sup>	8	14/0.30mm	50
EC108R	RED	1.0mm <sup>2</sup>	8	14/0.30mm	50
EC112K	BLACK	1.5mm <sup>2</sup>	12	21/0.30mm	50
EC112R	RED	1.5mm <sup>2</sup>	12	21/0.30mm	50
EC117K	BLACK	2.0mm <sup>2</sup>	17	28/0.30mm	50
EC117R	RED	2.0mm <sup>2</sup>	17	28/0.30mm	50
EC128K	BLACK	3.0mm <sup>2</sup>	28	44/0.30mm	30
EC128R	RED	3.0mm <sup>2</sup>	28	44/0.30mm	30
EC135K	BLACK	4.5mm <sup>2</sup>	35	65/0.30mm	30
EC135R	RED	4.5mm <sup>2</sup>	35	65/0.30mm	30

**SPEAKER CABLE TWIN CORE IN FIGURE OF 8 CROSS SECTION**

<b>EC210SPK</b>	BK/BKW	FIG 8	2.5	2 x 13/0.20mm	30
-----------------	--------	-------	-----	---------------	----



## TWIN CORE FLAT CABLE

Flat twin core cable easily splits into single cores. Add **PM** to end of code to buy cable by the metre.

<b>ECT21</b>	RD/BK	2 X 1 mm <sup>2</sup>	8	2.5X5mm	100
<b>ECT22</b>	RD/BK	2 X 2 mm <sup>2</sup>	17	3.5X7mm	100

## EXTRA FLEXIBLE BATTERY CABLE

Easier to use due to enhanced flexibility and recommended for marine use. Cable cross sectional area of core 20mm<sup>2</sup>, load rating 135 amps. Add **PM** to end of code to buy cable by the metre.

<b>EBC135K</b>	BLACK	20mm <sup>2</sup>	135	266/0.30mm	30m
<b>EBC135R</b>	RED	20mm <sup>2</sup>	135	266/0.30mm	30m

**EC153ORPM** 16A Orange mains cable 1.5mm 3 core/mtr  
**EC153OWTPM** 16A White mains cable 1.5mm 3 core/mtr  
**ECSATWPM** SAT & TV 750hm 1mm core 64X0.12 braids



**EPVCTBLK** Black  
**EPVCTRED** Red  
**EPVCTYLG** Yellow / Green



**EWST150** Wire stripping pliers 150mm



**EWCRPL** Crimping pliers 250mm



ECT... various crimp terminals

**SEE PRICE LIST FOR DESCRIPTION**



**EAD01** Croc clips and lighter type socket.



**EAD02** Lighter socket twin cable splitter



**EAD03** 12V Triple Socket Silver 10A fuse & LED



**EAD04** Lighter socket curly cord 10' 2.5m extension 5A



**EAD09** Double socket with 90 deg swivel plug & LED

## Low Voltage Protector



**EAD06** Battery saver. Will turn off accessory when battery falls below 11.6v 10A fuse & swivel plug.



**EAD07** 12V Input voltage converter. Regulated Output 800mA DC 1.5,3,4, .5, 6,7.5,9,12V Inc 6 plug adaptors



**EAD08** Triple socket 10A with swivel plug. Will allow use of Original Cigar lighter plug in the adaptor.

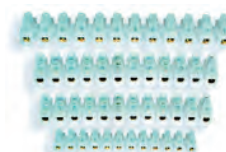

**TERMINAL STRIPS**  
**ECTS3** 3 AMP  
**ECTS6** 6 AMP  
**ECTS10** 10 AMP  
**ECTS15** 15 AMP  
**ECTS30** 30 AMP



**EAD23012** 230 volt to 12 volt converter 0.5 Amp @12volt. Ideal to power or charge 12v equipment at home



**EADTRKCHG** Compact 500mA constant output plug-in charger. Suitable for most 12v automotive batteries. Fitted with crocodile clips & 1.6m cables.



**EDIMM** Digital Multimeter DC & AC voltage, DC current & resistance, continuity, diodes, NPN & PNP. Supplied earth & test leads and 9v battery. Large digital display for easy readings



**VOSC612** 12V Oscillating 6" fan is a high performance model designed for use just about anywhere. Powerful yet quiet motor; smooth switch able oscillating action & full chromed metal mesh front and plastic rear cage for safety. Screw-mounted will plug into any 12V lighter socket.



**IRNO1** Mini travel iron 12v 5A. Built in thermostat with rotary temperature control. Folding handle for compact storage. Cable (1-2m) with cigarette lighter plug.



**HDY01** 12 volt hairdryer with folding handle for compact storage. With 2m of cable & cigarette lighter plug. Current consumption 180 watts.

WE NOW OFFER INSTALLATION AND REPAIR SERVICE BY [SupremeTech.co.uk](http://SupremeTech.co.uk)



0844 414 2324



0844 414 2425



# INVERTERS, AGM BATTERIES & ACCESSORIES



Electrical



**R331** Pair of battery terminal connectors with protection covers



**RBATQC** Battery snap on quick connectors.



**R294** Master battery isolator switch 100Amp or 500Amp for 10 sec's.  
**R294C** Spare key for R294 above



**R295** Master battery isolator switch 150Amp or 1200Amp for 5 sec's.  
**R295C** Spare key for R295 above



**R228** Relay70A for linking batteries for split charging & running fridge 12V feed from engine.



5 pin change over relay  
**R220CH** 12v 20/30amp  
**R240CH** 24v 10/20amp



**R224** 24V Relay 20A for linking batteries, switching high loads or split charging feed from engine.



**R225** 24V Heavy Duty Relay 50 amp 4 pin relay for very high power switching needs.



**R230** Relay 12V 30 amp smaller capacity 4 pin relay for lower power switching needs



**R230F** Relay 12V 30 amp 4 pin with built in 30Amp blade fuse

## NEW SOLVER BATTERY MAINTENANCE SYSTEM



Solver is an electronic device that eliminates the sulphation of lead batteries. Providing longer life, enhanced performance & more power from your batteries. See our website for more information on this excellent energy saving device.  
**BSO121 SOLVER BATTERY MAINTENANCE SYSTEM 12V 120Ah**



**CSB40-SP** Automatic battery separator relay with 3 fused 12 volt equipment outputs



**R232T** Twin on off Relay 2 x 12V 30 amp relays in one casing



## VOLTAGE SENSING FRIDGE AND CHARGING SMART RELAY- R107VSR

Easy to fit smart split-charge relay is triggered by the rise in the main vehicle battery voltage when it is being charged by the alternator. (ie when the engine is running). The self-switching relay provides power to the caravan whilst prioritising the towing vehicle's battery - in heavy-load conditions (such as air conditioning in full in a traffic queue at low RPM), the caravan power will cut out if the towing vehicle's battery is under heavy load and not receiving a charge - the supply resumes when the charge rate increases, ensuring that the refrigerator or auxiliary battery charge does not drain or over-stress the main vehicle battery. As this is a self switching unit it requires no connection to the alternator.

**R107VSR 30 AMP SMART VOLTAGE SENSING 2 OUTPUT RELAY**



R107VSR

## SEALED AGM (Absorbed Glass Mat) HIGH QUALITY BATTERIES

High Quality Units by Banner Batteries Made in Austria for reliability Sealed AGM: (Absorbed Glass Mat) originally developed for military aircraft where power, weight, safety and reliability were paramount considerations. Faster Recharge, Sealed, Totally Maintenance Free, Much better charge retention deep cycle battery. Higher resistance to vibration Higher bulk charge acceptance rate (which means up to a 15% shorter recharge time and reduced cost). Can be used in saltwater applications.

Using a VRLA sealed AGM battery is recommended inside a semi-enclosed area, like the passenger compartment, as it is safer than a wet battery being spill, leak proof, non gassing & can be mounted in virtually any position even on its side! (because it is totally sealed and maintenance free). In most cases AGM batteries will give longer service life & greater cycle life than a wet cell battery. They have particularly low self discharge rate (typically 1%-2% per month) so that they will not go flat during long periods without charge. Our Premium BANNER AGM range of batteries are perfect for Caravans, Motorhomes, Horseboxes, Boats & Specialist Vehicles. 3 year warranty. **THIS PRODUCT CAN BE SENT BY CARRIER**

STOCK CODE	L X W X H	Ah (20Hr rate)	Ah (100Hr rate)	Terminal Type	Terminal Thread	Weight
BTAGM070B	278x175x190	75	85	POST	-	22
BTAGM080B	315x175x190	80	90	POST	-	25
BTAGM100B	354x175x190	92	110	POST	-	28
BTAGM110B	328x172x222	110	122	F12	FM6	32
BTAGM135B	340x173x280	135	145		FM6	40
BTAGM150B	482x170x242	150	165	F12	FM6	44
BTAGM200B	520x240x220	200			FM8	66
BTAGM230B	521x269x203	230			FM8	70
BTAGM065	345x165x175	65	75	F11	FM8	19

The Platinum BTAGM065 is specially sized to fit under the Ducato X250 front seat Terminal conversion posts are available. They simply crew into the FM8 thread to provide a conventional round Auto battery post if that is required.

**BTAPOSTM8** Battery post kit M8 **BTAPOSTM6** Battery post kit M6

## PREMIUM QUALITY BANNER ENERGY BULL LEISURE BATTERIES.

Premium semi-traction thick plate lead acid leisure batteries with true capacities, backfire & spill protected. O.E.M Quality. (Ah 20h/100h rating)

- BTEBL075** 75/85ah L256 x W174x H225
  - BTEBL080** 80/90ah L278 x W175x H190
  - BTEBL100** 100/110ah L354 x W175x H190
  - BTEBL115** 115/135ah L350 x W175x H230
  - BTEBL130** 130/140ah L514 x W189x H220
- COLLECT ONLY**



BTEBL080



BTAGM070B

## THRU FLOOR BATTERY BOX

Complete with lid and battery retaining strap. Max battery size 375mm long x 175mm wide x 240mm high. Floor cutout 400 x 200 approx, Flange size 475 x 275.

**RBATTFB THRU FLOOR BATTERY BOX**

## STANDARD QUALITY VOYAGER 'WET' LEISURE BATTERIES

Made by Banner for use in leisure applications with mains hook up. **COLLECT ONLY**

**BTVOY075** 55ah @20h (75ah @ 100h) L272 x W172x H220

**BTVOY110** 90ah @20h (110ah @ 100h) L344 x W172x H235



BTVOY075

Buy securely online at Leisurelines.net



**MCLP** Loose Blue CEE mains connection plug male



**MCLS** Loose Blue CEE mains connection female Socket with hinged cover



**MCLUK** UK adaptor female socket



**MCLE** Continental adaptor female socket



Mains input lead with connectors.  
**ML10** 10 Metre



**EPOLTEST** Polarity tester safety checks correct wiring of hook up supply



**MLUKSKT** Converter blue 16A to UK 3 PIN household socket



**MISURF** Mains inlet surface mount blue 16A



**MLHMWS** Home mains wall mounted blue 16a socket



**MLSP3** Mains lead splitter Blue 16A



**MLSP2UK** Mains lead splitter Blue 16A + UK 3 pin household socket



**MLSP2CAB** Mains lead splitter blue 16A with 2mtrs of inlet cable



**MLERL** empty cable reel.  
REEL CAPACITY  
50mt - 3x1.5mm<sup>2</sup>  
40mt - 3x2.5mm<sup>2</sup>  
30mt - 3x2.5mm<sup>2</sup> H DUTY



Flush fit external mains inlet socket with profiled lid.  
**MIFFB** colour black,  
**MIFFW** colour white.



Mains inlet socket styled to match F30/1 water filler (page 19). Sizes 137mm High x 122mm Wide. Cut out oval 90mm H x 85mm W.  
**MIF30** White mains inlet  
**MIF31** Black mains inlet



**MPEXBOXW** Flush fitting external one module box. Designed for any CBE modules to be installed  
Size 125mm W x 140mm H overall Colour: white  
**MOUTW** Flush fitted mains outlet socket for 3 pin UK 13 amp plug Size 125mm W x 140mm H overall Colour: white



outlet socket for 3 pin UK 13 amp plug Size 125mm W x 140mm H overall Colour: white



**MLTDY**  
Simple frame to wind on mains cable for storage



**MCLSKT** Converter lead blue 16A plug to UK 3 PIN household socket



**MLLRCD** In Line 16 amp mobile RCD  
Ideal for tenting or garden power products, Wired between the appliance & mains plug, Reset & test light facility, Trip speed: 30mS, Can be used in damp & wet conditions



**MCU2516** Mains consumer unit fitted with a 25 A / 30mA RCCB residual current device and 2 MCB's 1 x 6 amp 1 x 10 amp.  
Dimensions 200 x 112 x 90mm



**MCLP90**

**MCLP90** Loose 90 degree Blue CEE mains connection plug



**MCLS90**

**MCLS90** Loose 90 degree Blue CEE mains connection Socket with hinged cover.



**MCLS90SCHUKO**

**MCLS90SCHUKO** Loose 90 degree Blue CEE mains connection Socket with hinged cover. Secondary SCHUKO connection with hinged cover

## SOME GUIDANCE ON DESIGNING YOUR MAINS & 12 VOLT ELECTRICAL SYSTEM

The electrical system is a very important part of your conversion. It is important to ensure it is installed in a correct manner by a competent person and inspected for safety regularly. More help in specifying a correct Mains Electric and 12 volt electric system can be found on our website: [www.caktanks.com/advice](http://www.caktanks.com/advice)

### INVERTERS

12v Modified Sine Wave Mains Inverter provides portable mains power on the move. The unit plugs simply into your cigar socket in your car, boat or caravan, providing 240v mains electricity. Input voltage 10.5-15v, Low battery alarm and auto shut down, output 230v 50 Hz with standard UK 3 pin socket and built in on/off switch. Over temperature protection, Short circuit protection & overload protection.

- INV24060** 24 volt 540 watts continuous output
- INV12070** 700 watts continuous output
- INV12100** 1000 watts continuous output
- INV12200** 2000 watts continuous output



### IN-CAR INVERTER

Equips vehicle with three pin power socket to provide portable mains power on the move. Overload, short circuit, over voltage & over temperature protection. Low voltage shutdown feature. Power your laptop, mobile phone, DVD play appliances.

- INV12016** 200W Plug in Inverter 140 watts continuous output



WE NOW OFFER INSTALLATION AND SAFETY INSPECTION SERVICE BY [SupremeTech.co.uk](http://SupremeTech.co.uk)



0844 414 2324



0844 414 2425



# GENERATORS



Electrical

## ECOENERGY

The New range of **TELAIR ECOENERGY** generators will make you independent from charging stations - ensuring long range and comfort. Immediate current output via an inverter allows household appliances such as hair driers, toasters or microwave ovens to be used efficiently as required. You'll be able to enjoy your summer even in + 50°C temperatures as your ECOENERGY ensures maximum comfort without having you worry about battery consumption. The living will be easy in wintertime, too, because ECOENERGY can guarantee a continuous source of power down to temperatures of - 25°C (using onboard bottled propane gas or high propane content LPG Autogas). **Eco-friendly:** LPG (or propane gas) operation to ensure compliance with the latest environment protection standards. **Low-noise:** the operating noise is extremely low (51dBA only) and muffled: no more complaints from your neighbours! The "Motor dynamo" system will produce **12V** electric energy with an impressive **20 - 25 Amps/hour** according to models. No extra tanks needed as the gas bottle already part of your camper equipment will be used. A small-sized (W 565 x D 380 x H 250), compact, lightweight system( only 19kg) - offering ideal, safe solutions for underfloor external installation also in campers with low-floor chassis. Unrivalled performance when it comes to withstanding countless power on/power off cycles.



### Telair EcoEnergy Gas generators

- GENTG480** 20amps/hour model
- GENTG480MEF** 20amps/hour model with MEF
- GENTG600MEF** 25amps/hour model with MEF

Chassis & Floor Installation Brackets and upgrade options are available

### HONDA PORTABLE GENERATORS

• Honda Inverter Technology ideally suited for use with sensitive electronics due to a clean sine wave of energy that prevents surging. • Honda Oil Alert system will shut the unit off when the oil drops below a safe operating level. • DC terminal for charging 12-volt automotive type batteries (requires additional lead). • The Honda EU range is the best choice for stable power whether for the caravan, motorhome, boat or standby power during power cuts. Honda 5 year Warranty. Produce only 59dB of sound at 7 meters with a full load, which is less than the rating of common speech. The Honda **EU10i** small super quiet Honda generator is extremely portable (at only 29 lbs / 13Kgs.) as well as fuel efficient. Will run for up to 8.3 hours on a single tank of fuel, when used with the Honda Eco Throttle feature. At only 46.3 lbs (21 kg), the Honda **EU20i** generator utilizes Honda's "state of the art" inverter technology to provide 2000 watts of lightweight, quiet and efficient power. It will run up to 10 hours on a single tank of fuel when used with Honda's Eco Throttle feature.



- GHEU10i** Honda EU10i Portable Generator 1Kva
- GHEU20i** Honda EU20i Portable Generator 2Kva

### DOMETIC INTEGRATED GENERATORS

We offer the full range of generators and accessories please ask for any Dometic item not in our catalogue.

#### Dometic TEC 29

The top seller in the range! Super-compact dimensions, light weight of just 44 kg and, with its 2600-watt capacity, just as powerful as conventional predecessor models. Petrol-fuelled engine, modest energy consumption, very quiet running. Suitable as a power source for all Dometic air conditioners.

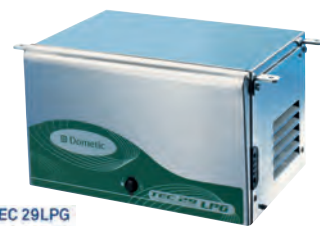

Dometic TEC 29LPG

#### Dometic TEC 29LPG

The tried and tested TEC 29 is now also available as a gas model. The same benefits, same performance, minimal noise and odour emissions, extremely high efficiency.

#### Dometic TEC 40D

This low-noise diesel generator is new in the camping / caravan range and has already proved itself to be highly reliable in tough everyday use. It can get something going with 3500 watt continuous output using very little fuel. That is also enough to run two Dometic motorhome air conditioners at the same time.



Dometic TEC 40D

#### Dometic TEC 30EV

Environment-friendly with diesel fuel, and the most economical generator in the range with a fuel consumption of 0.7 litres per hour. Purpose-designed for use in larger motorhomes and utility vehicles. Low-noise operation thanks to excellent sound insulation. Suitable as a power source for all Dometic air conditioners.



Dometic TEC 30EV

#### Dometic T2500H

Favourably priced, reliable appliance. Compact design, light weight. Low-noise, high-performance petrol engine [ 5.5 HP ], economical consumption. 2000 watts continuous output – enough to supply several electrical appliances at the same time, or Dometic air conditioners of matching power rating.



Dometic T 2500H

#### Dometic T4000H

A genuine mobile power station! Generous 3500-watt continuous output – plenty of power for two Dometic motorhome air conditioners. Tried and tested unit with high-performance petrol engine [ 9.0 HP ].



Dometic T 4000H

**MUST BE INSTALLED BY A QUALIFIED FITTER IN CONSULTATION WITH DOMETIC**  
**WE NOW OFFER INSTALLATION SERVICE IN KENILWORTH BY [SupremeTech.co.uk](http://SupremeTech.co.uk)**

Buy securely online at [Leisurelines.net](http://Leisurelines.net)





## The WAECO PerfectView Camera & Monitor kits

The two flat-screen 5" and 7" monitors use LCD technology and LED backlighting ensure a premium picture display. Large, easily to reach pushbuttons, the monitors can be removed without the cabling to protect them from theft. Other key features; LED background illumination, Optimum picture quality even at low temperatures, Two camera inputs with signal detection, Real-view or mirrored picture function via monitor, Picture settings can be saved for each camera input, USB-battery output, For 12-volt to 30-volt operating voltage. Two brand new cameras (CAM 50C & CAM 80C) & the tried-and tested twin cameras CAM44 & CAM 33C1 ensure that no user wish goes unfulfilled. Other key features; cameras feature infrared Led's for night view, temperature controlled heater, IP68 rated camera housing, CAM80C offers 145o extra wide picture, REVERSING CAMERA KIT CONTENTS: 5" or 7" LCD colour monitor, colour CCD camera, 20 m monitor-to-camera connection cable, set of cables for monitor, installation fittings for all components, instructions. OPTION: All Waeco systems have option to fit a second camera and MagicWatch DMWE850RV Integrated Parking Distance Aid.

### WAECO PerfectView



PerfectView RVS550      PerfectView RVS750

### WAECO PerfectView



PerfectView RVS580      PerfectView RVS780



### Entry-level reverse vision

Elegant colour camera in silver or white. Also featuring the 5" or the large 7" monitor. Two impressive basic solutions at an attractive price. CAM50C Camera available in white or silver.

- DRVS550 5" LCD & CAM50C SILVER KIT
- DRVS750 7" LCD & CAM50C SILVER KIT
- DRVS750W 7" LCD & CAM50CW WHITE KIT

### ... and for pros

The compact CAM80C motorised shutter camera sees more than the others: its wide 145° picture angle even detects peripheral obstacles. Two system versions with a 5" or 7" monitor.

- DRVS580 5" LCD & CAM80C SILVER KIT
- DRVS780 7" LCD & CAM80C SILVER KIT

### For optimal close-range and distance vision

Two systems with the unique colour twin camera with a motor operated shutter. The camera is equipped with a wide-range & a telescopic lens and therefore allows both excellent close-range and distance vision.

- DRVS594 5" LCD & CAM44 SILVER KIT
- DRVS794 7" LCD & CAM44 SILVER KIT

## WAECO SinePower MSI

SinePower inverter series with continuous power ratings of 150 - 2500 watts clearly come up to professional standards. Delivering pure sine wave voltage, they are the best possible choice for highly sensitive and powerful electrical appliances. They meet industry standards and combine ultimate user comfort with invaluable technical features. The mains supply priority circuit with voltage synchronisation, for example, switches to the mains power as soon as it is available and ensures uninterrupted voltage supply to the connected appliances with a smooth switch-over. Or the automatic activation of the "sleep mode" when no 230 volt appliances are being operated - saving energy and reducing the strain on the on-board battery!

Optional remote wall control panel; DMCR9 Simple version with on off and LED indicator, or DMCR7 Low-voltage, over-voltage, Power on indicated by red LED overheat and overload indicated by red LED's, stand-by and power on indicated by green LED's. Both have 7.5mtr connection cables.



DMSI912/1312/1812



DMSI1812T



DMSI212

Model	Volt age	Continuous Power	Peak power	Mains Priority	W	H	D
DMSI212	12	150W	300W	No	124mm	49mm	199mm
DMSI412	12	350W	700W	No	124mm	49mm	199mm
DMSI912	12	900W	1900W	Opt	198mm	94mm	291mm
DMSI1312	12	1300W	2900W	Opt	198mm	94mm	324mm
DMSI1812	12	1800W	3900W	No	198mm	94mm	376mm
DMSI1812T	12	1800W	3900W	Yes	198mm	94mm	406mm
DMSI2312T	12	2300W	4000W	Yes	283mm	128mm	436mm
DMSI3512T	12	3500W	6000W	Yes	283mm	128mm	496mm

## WAECO PerfectPower



PP1002



PP2002

**DPP1002** - 12v DC Modified sine wave inverter.  
Continuous power 1000W  
Peak power 2000W  
(WxHxDmm) 176 x 95 x 338

**DPP2002** - 12v DC Modified sine wave inverter.  
Continuous power 2000W  
Peak power 4000W  
(WxHxDmm) 176 x 95 x 443



### WAECO SinePower Accessories - Remote wall control panel



**DMCR9** Standard version with on off and LED indicator. Connection cable 7.5mtr. For use with :  
DMSF702 - DMSF2512  
DPP1002 - DPP2002

**DMCR7** Low-voltage, over-voltage, Power on indicated by red LED overheat and overload indicated by red LED's, stand-by and power on indicated by green LED's. 7.5mtr connection cable. For use with :  
DMSF702 - DMSF2512

**WE CAN SUPPLY ANY DOMETIC - WAECO PRODUCT THAT IS AVAILABLE. PLEASE ASK.  
WE NOW OFFER INSTALLATION AND SAFETY INSPECTION SERVICE BY [SupremeTech.co.uk](http://SupremeTech.co.uk)**



**0844 414 2324**



**0844 414 2425**



# AVTEX LCD TV's & ACCESSORIES



Electrical

Buy securely online at Leisurelines.net

AVTEX the brand for mobile 12 volt TV's. Superior build quality - designed to withstand the vibration of being moved around constantly. Highest quality screens with wide viewing angles and high grade components and build quality for long term reliability - ease of use - simple one button tuning with AQT - Designed for purpose not converted household mains TV's - from the outset AVTEX LCD TV's are designed to primarily operate on 12 volt dc reducing battery consumption by not needing power hungry mains transformers - comprehensive range of screen sizes with and without DVD player - multi standard digital Freeview and analogue tuner for use in UK & many European countries - excellent after sales service from AVTEX. Ideal for any mobile application, Motorhomes, Marine, Horseboxes, Narrowboats, Caravans & Camping.

## AVTEX 16" LCD TV

The W164DR COMBI is the most popular product in the stylish Avtex range. Loaded with functional, convenient features such as one button tuning and pause live TV even instant or schedule recording on to USB or external hard drive, yet still being very easy to use. The W164DR has a 16" widescreen LCD display with viewing angles and picture quality that we think you'll find hard to beat. Size 387W x 287H x 68Dmm Weight 5.1kg  
**TVW164DRK** Black Digital TV/DVD/CD/PVR.

W164DR/  
W164DRS



W164TR



## New TVW164DRSK now with built in HD FTA Satellite tuner as well as Freeview tuner.

**TVW164DRSK** Black Digital TV/DVD/CD/PVR/ SATELLITE

Designed for the leisure industry the W164TR benefits from the same high quality 16" LCD display as the W164DR, to combine superior viewing angles and picture clarity with uncomplicated operation. Size 387W x 287H x 68D mm Weight 3.5kg  
**TVW164TRK** Black Digital TV

L185DR /  
L185DRS



L185TR



## AVTEX 18.5" LED TV

The beautifully styled, Ultra-Slim L185DR TV / DVD Combi is loaded with functional, convenient features such as One Button Tuning and Pause Live TV even instant or schedule recording to USB or external hard drive, yet remaining very easy to use. The L185DR has a high specification low power 18.5" widescreen LED display, with viewing angles and picture quality that we think you'll find hard to beat. Size .352.2W x 475.8H x 99.2D mm Weight 4.3kg  
**TVL185DRK** Black Digital TV/DVD

NEWL216DRSK



**TVL186DRSK** now with built in HD FTA Satellite tuner as well as Freeview tuner  
**TVL186DRSK** Black Digital TV/DVD/HD SATELLITE

## New TVL185DRSK now with built in HD FTA Satellite tuner as well as Freeview tuner

**TVL185DRSK** Black Digital TV/DVD/SATELLITE

## New AVTEX 21.5" LED ALL IN ONE TV - Freeview HD / HD SAT / Dvd / Rec

Watch TV like never before, in beautifully crisp sharp high definition with free HD channels. See programsthat are simply not available on a standard TV in up to five times more detail, with breathtaking picture quality, clarity and sharpness through your aerial or satellite dish. The new ultra slim L216DR LED TV / DVD / PVR combi just oozes class, quality and sophistication, packed with features such as the Avtex unique one button AQT tuning system, the ability to record or pause live TV to USB or external hard drive. The L216DRS sets a new standard in mobile portable entertainment systems.  
**TVL216DRSK** Black LED digital TV /SAT/ DVD / PVR

TVSATSNIPE



## NEW AVTEX SNIPER FULLY AUTOMATIC PORTABLE SATELLITE DISH.

Great new product from Avtex. Portable of roof mounted (with optional roof mount) satellite system with GPS auto skew for accurate one button satellite searching. Only 188mm high  
**TVSATSNIPE**

## NEW InovTech LED TV'S

### Practical Caravan Best Accessory Award 2012

InovTech use LED technology so that, as well as having excellent picture quality with wide viewing angles, the TVs themselves are thin, light and use very little power - around 2 Amps on 12V.

This is a true 12V TV and is supplied with a dedicated 12V lead the TV also has built in voltage stabilisation 9V - 30V making it ideal for Motorhomes, Boats & Trucks. Tuner DVB-T HD MPEG-2, MPEG-4 Digital Freeview. USB port included so you can PVR record programmes on the TV to a USB flash drive or portable device. Built in right loading DVD player, SD card reader, Touch Sensitive edge menu keys (presence of touch displays menu keys on the border of the screen), Media accepted DVD Audio/Video CD Audio/Video, Formats read JPEG,MP3,DivX, MPEG-2, MPEG-4. Consumption Max/usage/standby: 40/25/1 watts.

**TVINV156** InovTech 15.6" Widescreen HD LED TV DVD PVR with Digital Freeview tuner  
Dimensions: W 401 x H 281 x D 42mm. Weight 1.96kg.

**TVINV185** InovTech 18.5" Widescreen HD LED TV DVD PVR with Digital Freeview tuner  
Dimensions: W 461 x H 315 x D 49mm. Weight 3.26kg.



TVINV156



TVINV185

WE NOW OFFER INSTALLATION SERVICE BY  
**SupremeTech.co.uk**



# TV AERIALS



## WING

### 360° Omni-Directional TV Antenna 26dB UHF 9dB VHF-B3

MINI-antenna (diameter: 31cm only) specially designed to receive UHF channels. However, a special circuit configuration and a high-gain amplifier make it possible to receive VHF B3 programs too.

TVWNG Wing omni-directional TV aerial



#### Specifications

Gain with amplifier:	CH 2-4	0dB
	CH 5-12	9dB
	CH 21-69	26dB
Power supply:	12/24 Volt-230 Volt	
Diameter:	31 cm	
Height:	16.5 cm	
Weight:	1 Kg	

#### Package Contents

- 1 Antenna complete with 5 m coax cable and 3 F connectors
- 1 Adjustable gain amplifier, with 2 outlets for 2 TV sets, powered off 12, 24 and 230 volts.

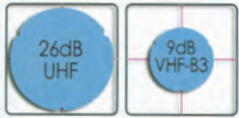

Horizontal reception diagram

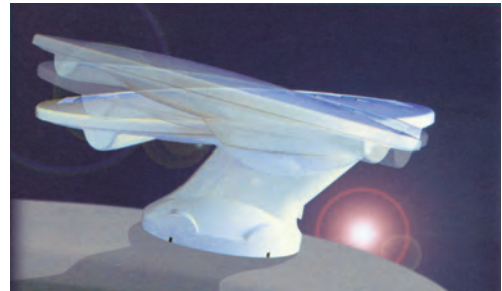

### Omni-directional HIGH SPEED TV Antennas

#### WING RANGE OF digital TV AERIALS (FREEVIEW COMPATIBLE)

They have been designed with an aerodynamic shape for the fastest campers. Each aerial has a special ergonomic foot to allow easy installation on even the most angular shaped roof of the latest streamlined campers and caravans. All Wing models have been designed to receive Terrestrial Digital TV signals using 30+ channel DVB-T FREEVIEW set top box from home for the future, while still being able to receive all the existing Analog TV channels. (To receive Freeview a decoder must be present)..

## WING11

### 360° Omni-Directional TV Antenna 26dB UHF 16dB VHF-B3

A combination of electronic amplifier high sensitivity to receive weaker TV signals and special antenna design enable you to receive TV programs at the lowest frequencies, too, while maintaining outside dimensions within 38 cm.

TVWNG11 Wing 11 high sensitivity omni-directional TV aerial



#### Specifications

Gain with amplifier:	CH 2-4	3dB
	CH 5-12	16dB
	CH 21-69	26dB
Power supply:	12/24 Volt-230 Volt	
Diameter:	38 cm	
Height:	16.5 cm	
Weight:	1.2 Kg	

#### Package Contents

- 1 Antenna complete with 5 m coax cable and 3 F connectors
- 1 Adjustable gain amplifier, with 2 outlets for 2 TV sets, powered off 12, 24 and 230 volts.

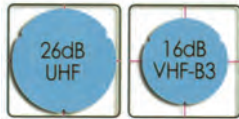

Horizontal reception diagram



### NEW TELEPLUS X2

New aerial with pivot mechanism for Horizontal and Vertical polarity adjustment from inside the vehicle. Thanks to this it is possible to receive all TV (Digital & Analog) signals which are transmitted on both horizontal and vertical polarity with top performance and higher sensitivity to weak signals. High gain 38 dB with amplifier. (Digital broadcasting caused the vertical polarity signals to increase in some countries such as Italy & UK). Great for boats.

TVPLUS2LP  
TVPLUS2SP

Teleplus2 165cm pole TV aerial  
Teleplus2 39cm pole TV aerial

### EXTERNAL TV AERIAL INPUT/OUTPUT

The external TV Aerial socket comes with 5 metres of 75 Ohm cable complete with pre fitted male plug. The exterior socket has a female connection. Socket is 50mm Wide x 32mm High and requires a 26mm hole. Easily fitted with 2 screws and Sikaflex 512 sealant. Colour: White.

TV9608AW

External TV aerial socket.



TVSFTVSAT



TVSFTV

### UHF TV SIGNAL FINDER - TVSFTV

Designed and Developed by a Caravanner for the Leisure Market. A pocket sized UHF TV signal finder designed to enable you to ensure that your directional aerial is pointing in the correct direction for optimal reception. Simply connect the aerial lead from your TV equipment to the TV Signal Finder then rotate the aerial until the greatest number of led's are lit, this indicates the strongest signal and therefore the best position for your aerial. The unit is supplied with full instructions, a PP3 battery and is guaranteed for 12 months. Designed and Manufactured in the UK.

### COMBINED UHF TV & SATELLITE SIGNAL FINDER - TVSFTVSAT

NEW and UNIQUE product. UHF TV and Satellite signal finder in one neat & simple to use unit. Even greater sensitivity - 12 Led's plus an audible signal indicator-and is ideal for the more remote areas of the UK, including Scottish Highlands, Lowlands and Ireland. The most sensitive TV signal finder of our range and probably on the market, with the added bonus of a built in Satellite Finder. The unit is supplied with a battery, 30cm patch cable and full instructions. Extra bright led's are used for daylight operation plus an audible signal level indication. As used by professional aerial installers who pay £hundreds for the nearest equivalent test meter!! A "must have" if you watch TV in your caravan, motor-home or boat. Designed and manufactured in the UK.

WE NOW OFFER INSTALLATION SERVICE BY [SupremeTech.co.uk](http://SupremeTech.co.uk)



0844 414 2324



0844 414 2425



# TELECO SATELLITE SYSTEMS



Electrical

Buy securely online at Leisurelines.net

## MANUAL SATELLITE DISH SYSTEM EQUIPPED WITH DIGITAL SAT FINDER AND ELECTRONIC INCLINOMETER

The Voyager G3 Digimatic has been specially designed and built by Teleco to make manual searching of digital satellites easier for the user in just a few, quick and simple operations. Currently, the biggest difficulty in manually locating a satellite broadcasting digital TV signals is linked with the fact that digital signals are displayed on TV screens with a certain delay. Therefore the user is forced to carry out pointing in very slow movements to prevent the risks of going past the required satellite without finding it. To solve this problem - shared by thousands of camper users - Teleco has applied the most advanced technologies in developing its new Voyager G3 Digimatic with DSF80/E Digital Finder, an electronic elevation meter displaying the absolute dish angle even when the vehicle is not level. The Voyager is installed with a digital inclinometer in the hinge providing an output reading of the dish angle. The DSF80/E is a device specially designed and built for all those users who wish to be able to quickly locate their required DIGITAL satellite with a manual dish system, avoiding all the "delay" issues connected with digital broadcasting. It is also extremely helpful for all the owners of LCD television sets (instead of traditional cathode ray tube TVs) which, being also the product of digital technology, will display pictures on their screens after a certain "delay".

50cm Dish will be fine in the UK, for most of Western Europe a 65cm will generally suit. But for southern Europe (France, Spain, Portugal and Italy etc) an 85cm system will be required.

**Voyager G3 Digimatic** Each Kit contains: • Pre-assembled satellite antenna, complete with folding mast and connecting cables. • Dish with Universal LNB • Digital Finder DSF80/E • Installation and operation manual.

**TVSVG350** Voyager G3 Digimatic 50 (49 x 45.5cm Dish)

**TVSVG365** Voyager G3 Digimatic 65 (72 x 67 cm Dish)

**TVSVG385** Voyager G3 Digimatic 85 (91 x 85 cm Dish)

**Voyager G3 is available with 52cm (LM) or 33cm (SM) Mast please specify at time of ordering**

**TVSVG365** Voyager G3 Manual 65 (72 x 67 cm Dish) Without digi satfinder

## TELECO DSF80 DIGITAL SATELLITE FINDER - TVDSF80

The easiest way to manually search for a satellite anywhere. Simply choose 1 satellite from the 8 preprogrammed, the sat finder will then only give you signal strength indications for that satellite. This is Ideal due to the all or nothing nature of digital signals. The DSF80 makes finding satellites as easy as using the much more costly professional installer units. An excellent piece of kit will save you lots of effort each time you set up. This is a similar finder to the one incorporated in the Voyager Digimatic G3 kit.

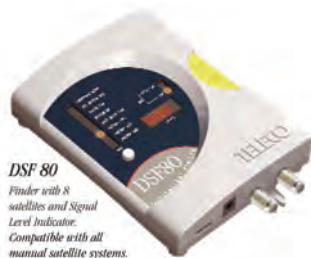

**DSF 80**  
Finder with 8 satellites and Signal Level Indicator.  
Compatible with all manual satellite systems.

## VOYAGER MOTOSAT

SEMI-AUTOMATIC MOTOR-DRIVEN SATELLITE ANTENNA

Equipped with 2-figure display built into mast that provides information on dish angle for ease of set up. **Voyager MotoSat is available with 52cm (LM) or 33cm (SM) Mast please specify at time of ordering** Weight: 85 DISH 10.2KG 65 DISH 8.0KG

**TVSVGMT65** Voyager MOTOSAT 65 (63.5 x 59 cm Dish)

**TVSVGMT85** Voyager MOTOSAT 85 (85 x 78 cm Dish)

## VOYAGER MOTOSAT DIGIMATIC

This model features a digital DSF80/E tracking unit with Beeper and LED indicator strip signal indicator.

**TVSVGMT65DG** Voyager MOTOSAT Digimatic 65 (63.5 x 59 cm Dish)

**TVSVGMT85DG** Voyager MOTOSAT Digimatic 85 (85 x 78 cm Dish)

## TELECO TeleSat

Stand-alone pointing system with wall mounted control panel, it can be coupled to any Satellite Receiver (not supplied). Especially suitable for connection to SKY receivers.

- Stores the most important satellites: Hot Bird, Astra19, Atlantic Bird3, Astra 28
- The safety system closes the antenna automatically upon starting the vehicle.
- Dish size: TELESAT: 63,5x 59 cm

**All operations are performed on a simple Wall Panel via 3 KEYS ONLY!**

1 key: Selects the satellite and starts the search 2 Antenna lowering key 3 ON/OFF key  
Control Unit •Power Supply: 12 Volt •Max Consumption: 2.0 A

•Size: 136x198x62 mm •Weight: 780 g

**TVSTLST65** AUTOMATIC SATELLITE ANTENNA WITH WALL PANEL

## TELECO AUTOMATIC SATELLITE SYSTEMS FLATSAT EASY

Stand-alone pointing system with wall-mounted control panel, it can be coupled to any Satellite Receiver (not supplied). Especially suitable for connection to SKY receivers.

Stores all the most important satellites: Hot Bird, Astra19, Astra 23, Atlantic Bird3, Hispasat, (Thor) Astra 28, Sirius.

The safety system closes the antenna automatically upon starting the vehicle

Supplied with wall control and dish control box. Requires suitable Satellite Receiver.

Twin LNB option available for connecting sky+

**TVSFSEY50** Flat Sat Easy 50: Dish size 49 x 45,5 cm Only 15cm High when folded

**TVSFSEY65** Flat Sat Easy 65: Dish size 72 x 67 cm Only 17cm High when folded

**TVSFSEY85** Flat Sat Easy 85: Dish size 91 x 85 cm Only 17cm High when folded



88 cm

**Voyager 65**

**Voyager 50**

**Voyager 65**

**Voyager 85**

Width 65cm

Width 88cm

Width 106cm

Depth 17cm

Depth 18cm

Depth 18cm

18 CTTI



MOTOSAT



DSF80/E



TELECO TeleSat Automatic Pointing Satellite Antennas



FLATSAT EASY



FLATSAT EASY CONTROL PANEL & CONTROL BOX

THE FULL RANGE OF TELECO TV & SATELLITE PRODUCTS ARE AVAILABLE AND CAN BE INSTALLED FOR YOU AT OUR [SupremeTech.co.uk](http://SupremeTech.co.uk) INSTALLATION CENTRE IN KENILWORTH.



## ROADPRO SAT DOMES

The ROADPRO Sat domes are the well respected sat domes formerly marketed under the Camos branding. As with all RoadPro dome systems, it's incredibly easy to operate; most users will only ever have to switch the control box on - that's it! When the sat-dome has found the satellite (usually within 30 seconds) the controller can be switched off so that they system uses virtually no power when in operation.

We recommend professional installation of any satellite TV system but with just one cable to connect to the controller and a simple 12V electrical connection, RoadPro sat-domes are easier to install than any other automatic satellite TV system.

### TVSD3201 RoadPro 30cm High Sat Dome static.

With all the advantages of a dome satellite TV system, this model is designed for use when the vehicle is parked. It's a low-profile model, measuring just 30cm high and so ideal when height is a consideration.

This model will pick up BBC, ITV and all UK channels as far south as southern France. Further south - as far as southern Spain - a variety of channels will always be available including BBC News, Sky News and most BBC radio stations. Six satellites are programmed into the controller so that - with a suitable receiver - hundreds of TV & radio channels are available all over Europe.

### TVSD3202 RoadPro 40cm High Sat Dome static.

With all the advantages of a dome satellite TV system, this model is designed for use when the vehicle is parked. Its larger dish gives maximum coverage across Europe. This model will pick up BBC, ITV and all UK channels as far south as Barcelona. Further south - as far as southern Spain and even Morocco - a variety of channels will always be available including BBC News, Sky News and most BBC radio stations. Six satellites are programmed into the controller so that - with a suitable receiver - hundreds of TV & radio channels are available all over Europe.

Optional mounting feet for easy removal of any RoadPro Sat-Dome we have special mounting plates. These are mounted permanently to the vehicle's roof and the sat-dome's feet are screwed to them.

## ROADPRO MECATRONIC SATELLITE SYSTEM - TVSDMEC80

Ease of use, reliable operation, rugged build quality using top quality components and a very competitive price are a great combination in this Mecatronic automatic folding dish system.

With its 80cm dish, it's an excellent choice for people travelling to Spain & Portugal, Italy or into eastern Europe.

Outside, the motor unit and dish are just 19cm high when the dish is parked and weigh only 15.5Kg. Inside, the control box can be hidden away and the display panel fits discreetly onto an interior panel.

There are only three buttons on the display panel: POWER ON/OFF, SATELLITE SELECTION and SATELLITE SEARCH. With a choice of all the popular satellites and an average search time of under one minute, satellite TV in your motorhome, caravan, truck or boat couldn't be easier!



**Warranty:** When fitted by **SupremeTech**, an approved RoadPro installer, all models have a five-year warranty which covers parts and labour against faults in manufacture or design. If the unit is not installed by an approved RoadPro installer, a three-year warranty applies. (This applies to units used for leisure purposes. If used for commercial applications, the warranty is for two years.)

Sat Dome search controller (Size 245mm W x 42mm H x 146mm) included with sat dome will search for Astra 2 (N & S) / Eurobird 1, Astra 1, Hotbird, Sirius, Atlantic Bird 3 & Hispasat satellites. No remote control or receiver included. Can be used with any satellite receiver including Freesat, Free to Air & SKY receivers or Televisions with built in satellite receivers. Current consumption when in use and search completed: <0.1 Amp. Weight of dish & motor Approx 9.5Kg. 76cm diameter installation area.



## TELECO DIGITAL SATELLITE RECEIVER - TVSTRFORCEHDCI+

Digital Satellite Receiver to receive all Free to Air programs and Encrypted programs with Optional CAM Module and viewing card.



Telair Energy Generators



Telair TG480 ECOEnergy



Telair Silent 7300H Airconditioning

As Authorised Dealers and Installers we can offer the full Teleco Satellite range and Telair Generators & Air conditioning Units. All products can be installed by [SupremeTech.co.uk](http://SupremeTech.co.uk) our onsite service and Technical centre.

## INNOVTECH REVERSING CAMERA SYSTEMS



Wireless reversing camera very easy to install without need for linking cables. Hi resolution 345000 pixels camera with LED'S for night vision. 105 deg visual angle, Waterproof IP65 rated. Monitor 7" (17.7cm) active matrix LCD TFT colour screen, Power 12 or 24v dc. W196 x H 127 x D 27mm  
**BVRVC7W** Kit wireless camera 7" monitor & mounts



Motorised reversing camera, with 18m of cable, allowing direct rear view or a panoramic view of the road. Defogging and defrosting function integrated into the camera.. Waterproof IP65 rated. Monitor 7" (17.7cm) active matrix LCD TFT colour screen, Power 12 or 24v dc. W196 x H 127 x D 27mm  
**BVRVC7MOT** Kit motorised camera with 18m cable 7" monitor & mounts.

WE NOW OFFER INSTALLATION AND SAFETY INSPECTION SERVICE BY [SupremeTech.co.uk](http://SupremeTech.co.uk)



0844 414 2324



0844 414 2425

## ALUMINIUM SERVICE DOOR FRAMES

Our range of service doors type A, smooth profile are installed without any externally visible screw fixings, they are installed by Sikaflex bonding (see page 115) of the frame to the aperture and the addition of some internal safety screws. They are manufactured from silver anodised Aluminium extrusions for long term visual appearance and strength.

When ordering service doors choose suitable lock or locks from the lock range on page 103. We do not supply service doors ready assembled with panel, we only supply frames as shown.

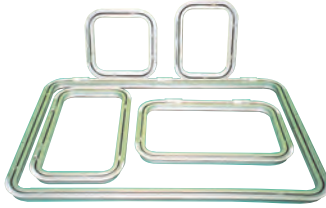

SHOWN WITHOUT LOCK OR PANEL FITTED

## THETFORD SERVICE DOORS

The range now covers four sizes. Easy to install, can be fitted either vertically or horizontally, in the outside wall of the body. A step by step installation manual is provided together with a template for cutting the wall and door centre core panel. The section of wall cut out to fit frame is trimmed down and fitted into centre of door. This ensures door centre panel matches any body colour styling. Add colour code to end of code.

Colours available: W = White or CW = Cream/White



All sizes in mm	TLTD3.. DOOR 3	TLTD4.. DOOR 4	TLTD5.. DOOR 5	TLTD6.. DOOR 6	TLTD7.. DOOR 7
OVERALL SIZE	385x335	685x385	785x335	1038x460	346 x 1108
DAYLIGHT OPENING	330X280	630X330	730X280	980X400	282 x 1051
LOCK/BUTTON	1	2	2	3	3
PUSH BUTTON	1	-	-	-	-

## NEW EXTERNAL RELEASE DOOR RETAINER

### DC6018K

New positive door retainer designed to fit on the exterior wall of the caravan. Due to its design it positively retains the door and will release with only a light pull on the trigger. A pair of spacers DC6009K are available to fit behind the trigger mechanism. (Colour Black)



DC6018K

## NEW TRIGGER RELEASE DOOR RETAINER -

### DC6010W

New door retainer designed to fit on the exterior wall of the caravan. It positively retains the door and released with only a light push on the trigger.



DC6010W

## LATCHING DOOR RETAINER

High quality strong latching door retainer. Retainer is fitted through 25mm door panel (screws supplied). Door is pushed onto retainer which is fitted to body side (requires screws) and latches fully. To release door pull on T handle and pull door off retainer.

A pair of spacers one flat one angled is available. Colour: Black.

DC6007K LATCHING DOOR RETAINER SET  
DC6009K SPACER KIT (1x Flat 1 x Angled)



## LOCKABLE ACCESS FLAP

High quality strong lockable access flap, providing access to service points or hidden filler positions. Colour white. Size 160mm high x 215mm long.

ACF03 LOCKABLE ACCESS FLAP

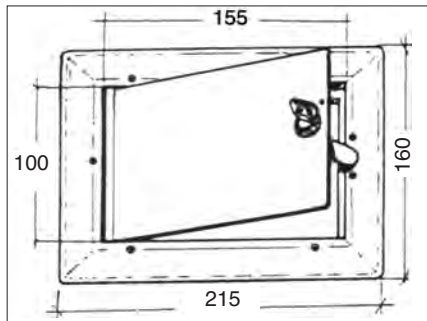

ACF03

## THETFORD BATTERY BOX

The Thetford Battery Box is intended to accommodate an auxiliary battery in a caravan or motorhome. The Battery Box has a CE socket to connect the vehicle to a 230 V power source. The Battery Box has the provision of space to be fitted with several sockets and outlets. The approx. side wall aperture is 297mm high x 597mm wide with a depth inwards of 250mm.

Panel thickness: the Battery Box access door can be fitted into panels ranging in thickness from 23 to 40 mm. Standard fit by many OEM's. The door requires a lockset TLZDLK see below to open and lock the door.

TLBBW THETFORD BATTERY BOX & DOOR CR/WHITE REQUIRES LOCKS

## THETFORD WET LOCKER

The Thetford Wet Locker Box is a waterproof storage compartment for caravans and motorhomes. The approx. side wall aperture is 297mm high x 597mm wide with a depth inwards of 347mm.

Panel thickness: the wet locker box access door can be fitted with panels ranging in thickness from 23 to 40 mm. Standard fit by many OEM's. The door requires a lockset TLZDLK see below to open and lock the door.

TLWLW THETFORD WET LOCKER & DOOR CR/WHITE REQUIRES LOCKS

## LOCK SETS FOR BATTERY BOXES AND WET LOCKERS

A pair of locks and 2 keys as a matching set for installation in the lock housings of the Thetford battery box and Thetford wet locker. The lock barrel is simply pushed home until it clicks to secure it in the housing.

TLZDLK PAIR OF ZADI LOCKS & KEYS FOR BATTERY BOX & WET LOCKER

We can supply any ZADI lock, barrel or keys. Please enquire.

All sizes are approximate. Do not cut hole until measuring the actual product.

We reserve the right to amend product specifications without prior notice. E & O E.



TLBBW BATTERY BOX



TLWLW WET LOCKER

WE NOW OFFER INSTALLATION SERVICE IN KENILWORTH BY [SupremeTech.co.uk](http://SupremeTech.co.uk)

## SINGLE KEY SYSTEM WITH NEW LOCK

For ease of use and to prevent a huge bunch of keys lock systems allow certain products to have the lock barrel installed afterwards. This enables a set of matching locks to be purchased and installed in a range of products so all will be able to be opened with the same key. Items marked 'requires lock' allow the installation of matching key number lock cylinders. Where products are marked with lock & two keys these key numbers are random and cannot be supplied matching. We can supply various lock spares and replacement keys please email picture of lock/keys for us to advise availability.

## LOCKS FOR SERVICE DOORS

To suit various styles and installation needs, the most popular service door lock is the **LDL1036**, due to its neat and simple operation and reliability in use. On unlocking **LDL1036** the knob pops out, rotate this to move pawl on rear to unlock & lock, then line up knob with base and push in until it clicks to lock. **LDL1035, 1047, 1105 & 1109** use turning of the key to rotate lock pawl on rear.

- LDL1035N** 1035 BARREL LOCK 32MM CHROME BODY REQUIRES LOCK (A)
- LDL1041CVK** BLACK COVER CAP & LOOP FOR 1035 & 1047 LOCKS (B)
- LDL1036L** 1036 BLACK DOOR LOCK WITH LOCK & 2 KEYS. (C)
- LDL1047** 1047 BARREL LOCK 38MM CHROME BODY REQUIRES LOCK (D)
- LDL1105W** MOON WHITE DOOR HANDLE LOCK LEFT REQUIRES LOCK (F)
- LDL1109W** MOON WHITE DOOR HANDLE LOCK RIGHT REQUIRES LOCK (G)
- LDLNK1** NEW LOCK 1 X LOCK & PAIR OF KEYS RANDOM NUMBERS (H)
- LDLWALK2** WEST ALLOY LOCK BARREL WITH 2 KEYS

## MATCHING FAP LOCK KITS

With the new lock kits order as many sets of locks at the same time as you need to complete the job. We will pick a 4 digit key number and this will show on your invoice instead of the stars. When you need to order extra matching locks in the future quote this key number in place of the 4 stars at the end of the lock set code.

- LDLNK4\*\*\*\*** NEW LOCK KIT 4 X LOCK & 2 X KEYS TO KEY NUMBER
- LDL1042NKB** KEY BLANK FOR NEW LOCK SYSTEM

## MATCHING ZADI LOCK KITS (lock number of our choice)

**LZDLK1** 1 x Zadi barrel & pair of keys **LZDLK2** 2 x Zadi barrels & pair of keys  
**LZDLK3** 3 x Zadi barrels & pair of keys **LZDLK4** 4 x Zadi barrels & pair of keys  
**LZDLK5** 5 x Zadi barrels & pair of keys **LZDLK6** 6 x Zadi barrels & pair of keys  
**LZDLK7** 7 x Zadi barrels & pair of keys **LZDLK8** 8 x Zadi barrels & pair of keys  
**LZDLK9** 9 x Zadi barrels & pair of keys **LZDLK10** 10 x Zadi barrels & pair of keys  
**LZDLK11** 11 x Zadi barrels & pair of keys **LZDLK12** 12 x Zadi barrels & pair of keys. We can supply other larger combinations of barrels and keys please enquire. We can also supply any number of individual Zadi barrels and keys to lock or key numbers. Please email us with your requirements.

## PLASTIC OPEN DOOR RETAINER CATCH

Door retainer catches for service and entrance doors. Male fixture has angled face to allow for hinging gap angle. Standard fit by almost all OEM's.

Colours available G= Grey, K= Black & W= White, Add this letter to end of code.

- DC1004** HIGH STRENGTH DOOR RETAINER CATCH (1 SET)
- DC1019** 10 MM SPACER BLOCK FOR DC1004

## BALL TYPE DOOR RETAINER CATCH

New larger variation on above door retainer, Ball design makes for easier lining up and positioning in any direction.

- DC1087** BALL TYPE DOOR RETAINER CATCH (1 SET)
- DC1088** 10MM SPACER BLOCK FOR DC1087

## HEOSAFE SECURITY CAB DOOR LOCKS

Many Motorhome and Caravan owners do not feel that the standard vertical locks are adequate protection against illegal entry. Many owners attempt to overcome the feeling by installing a range of various options from drilling and bolting in 'eyebolts, straps and chain' to Cutting holes and fitting 'dead locks/bolts'.

The HEOSafe however, has been designed by Oskar Kubesch to increase the safety of the vehicle and it's occupants against illegal entry whilst also removing the need for drilling and cutting holes into doors. The lock is mounted by using the existing fixings of the manufacturer and is very simple and easy to use.

The characteristics of the HEOSafe door lock are: Maintenance free; Quick and Easy to fit and use; No additional drilling or screwing required (excl. x250, Movano & Ford Transit door lock additional drilling and screwing required) & 3 year guarantee Standard Kit weight 2.00kg (delivered as a pair, left door and right door)

- HSL1246** Heosafe Fiat Ducato 230 Boxer Relay (1994-2002) standard
- HSL1256** Heosafe Fiat Ducato 230 Boxer Relay (1994-2002) lockable
- HSL12146** Heosafe Fiat Ducato 244 Boxer Relay (2002-2005) standard
- HSL12156** Heosafe Fiat Ducato 244 Boxer Relay (2002-2005) lockable
- HSL12546** Heosafe Fiat Ducato 250 Boxer Relay (2006- on) standard
- HSL12556** Heosafe Fiat Ducato 250 Boxer Relay (2006- on) lockable
- HSL1356** Heosafe Mercedes Sprinter lockable ( -2006)
- HSL1456** Heosafe Ford Transit lockable (2000 -2006)
- HSL14156** Heosafe Ford Transit (2006- on) lockable
- HSL1556** Heosafe Renault Master, Vaux Movano & Iveco Daily lockable

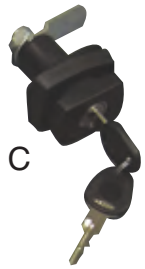
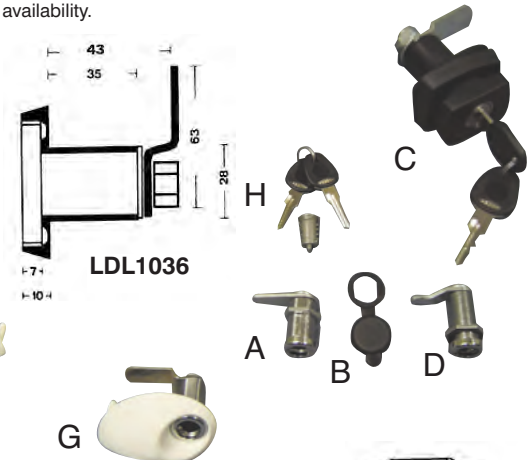

DC1004



DC1019 10mm SPACER FOR DC1004



DC1088 10mm SPACER BLOCK FOR DC1087



DC1087 DOOR CATCH

## NEW ZADI DOOR LOCKS

We have available the full range of ZADI replacement barrels and keys for Access and Entrance door locks as well as a selection of access door locks. We also have barrels and keys for West Alloy WD short barrel locks.



LZDL1037K



LZDL1051K



LZDL1052K



LZDL1046K



LZDL1048K



LZDLK1



HSL1356



HSL1456, HSL12556 & HSL1556



HSL12546



HSL1256 LOCKING HSL1246 NON LOCK



HSL12156



HSL12146

WE NOW OFFER INSTALLATION AND REPAIR SERVICE BY [SupremeTech.co.uk](http://SupremeTech.co.uk)



0844 414 2324



0844 414 2425



With the renowned quality and customer confidence in the C.A.K. range of products, we developed a range of cab window insulation screens. We have maintained our traditional high quality manufacturing standards, while producing at a sensible cost. Here we present the C.A.K. Products newly upgraded internal and external Thermal Screens™. **Our Thermal Screens™ Keep your vehicle warm in the winter and cool in the summer!**

## THE BEST JUST GOT BETTER

### NEW BX 9 LAYER INTERNAL THERMAL SCREENS™

New BX 9 layer silver insulated internal cab Thermal Screen™ kits come in sets of 3 pieces for Windscreen & 2 front Cab Doors with suction installation for most vehicles.

New improved Thermal Screen™ material with 9 layers to provide better insulation than our traditional 5 layer screens. Our internal Thermal Screens™ are designed for use in summer or winter. They fit quick and easily with suction cups that hold onto glass strongly, while being easily popped off when you want. It is scientifically proven that three layers of aluminised film provide 100% insulation in the summer, reducing solar gain. What's more the total thickness of 3 layers of 12 microns of Aluminium guarantees excellent insulation (the thickness normally applied to the windows of buildings is only 20 - microns). By combining this with 100gsm metalized film to also reflect heat and cold back through the glass, 100gsm of state of the art padding (the modern insulating material for ski-jackets, rescue blankets and technical uses), 3 x 1.5mm layers of expanded polyethylene foam and grey PVC nylon anti condensate inner fabric. We have therefore achieved outstanding winter insulation, eliminating more than 80% of condensation from windows. With the generous sizing of our Thermal Screens™ we ensure there are no cold gaps around the edges. Multiple layers also reflect the heat away in summer keeping the interior noticeably cooler.

See price list for applications list.

### NEW BX 9 LAYER INTERNAL THERMAL SCREENS™ COMPOSITION.

- 1st layer: 90 micron aluminised film, 3 layers with reinforcing mesh, to block out 90 % of UVA and reflect Cold.
- 2nd layer: 1.5 mm expanded polyethylene Foam.
- 3rd layer: 12 microns aluminised film.
- 4th layer: 1.5 mm expanded polyethylene Foam.
- 5th layer: 12 microns aluminised film.
- 6th layer: 1.5 mm expanded polyethylene Foam.
- 7th layer: 12 microns aluminised film.
- 8th layer: 100g anti-allergic polyester fibre insulating padding
- 9th layer: Anti-condensate PVC / nylon fabric.

All coming together to ensure a quality product that performs.

### INTERNAL SCREENS vs. EXTERNAL SCREENS.

External screens will provide slightly better insulation to windows and very little condensation on the inside than internal screens. But, external screens get dirty, even though we made ours from dirt repellent materials; it still transferred on the surface. And on wet mornings or when it is raining they have to be gathered in wet and allowed to dry off. Our internal screens on the other hand provide about 90 % insulation (100 % in summer) the 9 layer construction reflects the cold away back through the glass while reflecting the heat back into the vehicle. With the generous sizing of our screens there is a small amount of condensation left on the windscreen in the morning, but it is not 'running' with it. Internal screens are easy to fit on the inside with our strong suction cups, there is no going out into the cold or wet to fit them. Removal in the morning is just as easy; they are also clean and dry ready to pack away straight away. They neatly fold away to tuck behind the front seats. Considering this, on all of our own vehicles we use our internal Thermal Screens™. The ultimate solution for winter sports camping is to use both when parked up in sub Zero temperatures for extended periods

### NEW RANGE OF EXTERNAL ZIP FOLD DOWN THERMAL SCREENS™

A highly effective one piece insulation screen that fully covers the front windscreen and both front door windows. Installed with hooks and integral magnets to give a secure fit. Windscreen section folds down to provide light and vision. Manufactured from a strengthened 3 layer insulated waterproof material with silver aluminised foil to inner & grey waterproof finish to outside. In cold weather inner reflective surface reflects heat back into the vehicle while the outer surface reflects the cold away. In summer temperatures silver surface will reflect the heat away – keeping the interior cooler. Not for A class vehicles. See price list for selection of available models.

See price list for selection of available models.

### DIY SCREEN MATERIALS, ACCESSORIES & SPARE PARTS

For applications where a standard kit is not available, we offer the BX 9-layer screen material on the roll for making up of internal screens yourself. The edge finishing tape is sewn around cut edge to finish the screen. 2 part suction discs neatly fit to the material with the eyelet kits to fix the screen to window or rooflight. For other applications you could use Velcro as a method of attaching screens.

**BX9L15** BX 9 layer internal screen material 1500mm wide roll sold per metre

**BXET** BX sew on edge finishing tape per metre

Edge finishing tape is folded around the cut edge BX material you have cut to shape to give a neat finish. It is then simply sewn through with an ordinary sewing machine. Either by yourself or by a local clothing alterations service.

**CS10P** Eyelet and setting punch kit diy screens pack of 25

Eyelet kit comes as a pack of 25 male and female metal ring eyelet's and a punch and mandrel setting tool. The eyelets are simply placed in position on both sides of material, located on the punch and mandrel. A sharp tap on the mandrel will set the eyelet's together leaving a reinforced hole to install suction disc.

**CS1010** 2 part suction disc spares for BX internal screens pack of 10

The suction discs are made from high quality ultra flexible medical PVC, to ensure good adhesion to your glass. They are popped through the eyelet hole in your screen and the pull ring is clipped onto the rear.

E & OE

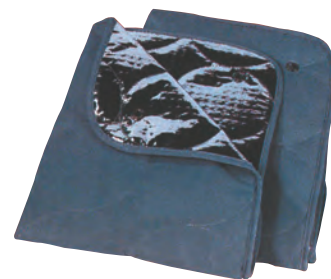

WE NOW OFFER INSTALLATION SERVICE IN KENILWORTH BY [SupremeTech.co.uk](http://SupremeTech.co.uk)





Hardback, 270 x 210mm, 176 pages, 480 colour illustrations  
Order code PUBH4221

## Build Your Own Motorcaravan

**By: John Wickersham**

One way to become the proud owner of a motorcaravan or camper van is to design and build it yourself. Not only can you create a distinctive holiday home, but you can also control the cost. Whether you want to fit out a van, renovate a camper; revive an old model or build one from scratch, this manual will show you how. It gives hands-on explanations about electrical systems, water supplies, storage ideas and saving weight when working with wood. All is revealed in this practical book.

**"Holds your hand through every process of creating a camper"**

Which Motorcaravan

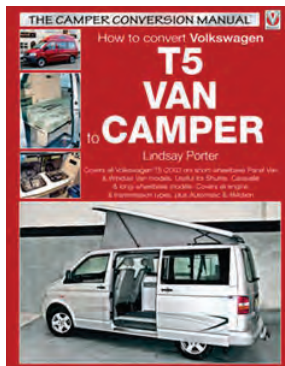

272 pages, paperback, 500 colour photographs  
Order code PUBT5VTC

## VW T5 Van - How to Convert to Camper

**By Lindsay Porter**

Have a great time converting your VW T5 van to a Camper - Follow the detailed, highly illustrated instructions in this manual and you can't go wrong! With 500 illustrations to show you how to chose the right panel van or bus for your needs, how to fit the roof, the windows and the whole interior. You'll save a fortune compared with the cost of buying a ready-converted Camper. A detailed step by step guide with 500 illustrations, covering every aspect of the conversion, you save a fortune and learn a lot!



Paperback, 220 x 130mm,  
Order code PUBH5264

## Motorcaravanning Handbook

**By: John Wickersham**

A motorcaravan gives you the freedom to take your home comforts with you in one self-contained unit wherever you choose to travel. Presented in a colourful, easy-to-follow format and small enough to fit in the glovebox, the Motorcaravanning Handbook contains the answers to any questions you may have about motorcaravanning, and covers everything from buying your vehicle and understanding how it works, to choosing and using sites. The first edition came 'unreservedly recommended' by Motorcaravan Motorhome Monthly (MMM) magazine, and this fully updated second edition will be essential reading for both potential motorcaravan purchasers and existing owners looking to maximise their vehicle's capabilities.



Hardback, 270 x 210mm, 216 pages,  
Full colour throughout

## The Motorcaravan Manual (3rd Edition) Choosing, using and maintaining your motorcaravan

**By: John Wickersham**

This radically updated third edition encompasses the very latest developments in motorcaravans. It is full of practical information for both new and experienced owners and includes an overview of models, maintenance and repairs on habitation elements, explanations of construction methods, practical advice concerning appliances, and detailed descriptions of motorcaravan supply systems. The content is invaluable for owners of both leisure vehicles based on van conversions and coachbuilt models constructed on a separate chassis. Guidance is also given on accessories, weight restrictions, modifications, restoration work and self-build projects.

Order code PUBH5124

## 'the number one guide for motorcaravanners' MMM The Caravan Manual (4th Edition)

**By: John Wickersham**

Servicing, maintenance and improvements First published in 1993 and having sold over 75,000 copies, this fourth edition of the Caravan Manual contains completely revised text and many new illustrations. As well as guidance on maintaining older caravans, it includes details about the very latest models. There's new information on caravan weights, the use of public weighbridges, and related legal issues, along with electronic and computerised wiring systems in cars. There are major updates to the chapters on chassis, running gear, body construction, gas and all electrical details. This essential manual describes all the vital maintenance tasks and repair work that keeps a caravan in tip-top condition.

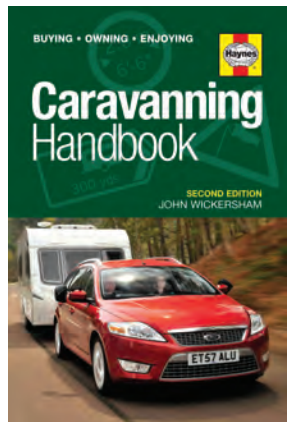

Paperback, 220 x 130mm, 336 pages, Full colour throughout  
Order code PUBH4830

## Caravanning Handbook (2nd edition) Owning, Enjoying, Buying

**By: John Wickersham**

The new, fully updated second edition of the Caravanning Handbook contains a wealth of information to help in the choice, purchase and use of a caravan. It is also an invaluable sourcebook when journeys are being planned and is an essential glovebox companion for use en route and on site. Presented in a colourful, easy-to-follow format, it gives advice on buying, towing, accessories, legislation and site procedures. It will also answer questions raised when using and looking after a caravan and includes chapters on electricity, gas, sanitation, refrigeration and heating appliances.

**'we cannot fault the content'** Practical Caravan



Hardback, 270 x 210mm, 216 pages,  
400 colour illustrations  
Order code PUBH4678

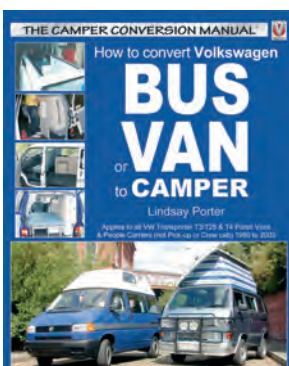

Paperback • 250x207mm • 224 pages • Over 800 colour illustrations  
Order code PUBT3T4

## How to Convert Volkswagen (T3/T25 & T4) Bus or Van to Camper

**By Lindsay Porter**

Step-by-step manual to converting a Transporter Van to a Camper. Incredibly detailed, step-by-step instructions and over 800 colour illustrations. Choosing the best van for your needs and preparing it. Guide to planning the layout and choosing fittings. Hot to fit a high-top, step-by-step. How to fit an elevating roof, step-by-step. How to cut panels and fit side windows. Building and fitting-out the interior furniture. Planning and fitting gas, water and electric components - with Safety notes.

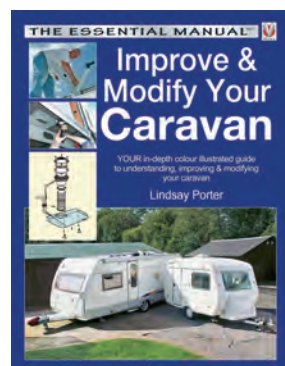

Paperback • 207x270mm • 224 pages • 975 pictures  
Order code PUBIMYC

## Improve & Modify Your Caravan

**By Lindsay Porter**

- The first ever book on choosing and fitting caravan upgrades and accessories
- How to carry out your own DIY improvements
- See what accessories are available to improve your caravan
- Find out how the experts carry out caravan improvements
- Advice on which projects are okay and which are not suitable for DIY
- See how to work successfully and without causing damage
- It details the huge range of improvements available and - crucially - how you can apply them to your own caravan.





# TABLES FITTINGS AND ACCESSORIES



Buy securely online at [Leisurelines.net](http://Leisurelines.net)

## NEW PIANO HINGES

- Plated steel or Stainless Steel continuous hinge 1980mm long.
- FFPNH252 25mm open (2 x 12.5mm leaves) NICKEL PLATED
  - FFPNH322 32mm open (2 x 16mm leaves) NICKEL PLATED
  - FFPNH322BP 32mm open (2 x 16mm leaves) BRASS EFFECT
  - FFPNH322ST 32mm open (2 x 16mm leaves) STAINLESS STEEL



New Piano Hinge

TSMN280

## NEW Hinged spring up flap bracket

- TSMN280 • Screw fixing • Suitable for extending tables and worktops
- For horizontal installation • Load carrying capacity up to 30 kg per pair
  - Yellow chromatised steel

## NEW CABINET HINGES

- FFCFH090 Cranked flush hinge
- FFFFH089 Flat flush hinge
- FFCFH117 Cranked flush hinge long strap



FFCFH117

FFCFH090

FFFFH089

## NEW FLAT HINGES

- Flat hinges in brass, ZINC plated steel or stainless steel
- FFHBF3530 35 X 30MM FLAT BRASS HINGE
  - FFHBF4035 40 X 35MM FLAT BRASS HINGE
  - FFHSSF3020 30 X 20MM FLAT STAINLESS HINGE
  - FFHSSF5030 50 X 30MM FLAT STAINLESS HINGE
  - FFHZF3022 30 X 22MM FLAT ZINC PLATED HINGE
  - FFHZF4028 40 X 28MM FLAT ZINC PLATED HINGE
  - FFHZF5030 50 X 30MM FLAT ZINC PLATED HINGE



FFHZFW2050

FFHZF4028

FFHSSF3020

## NEW WIDE LEAF FLAT HINGES

- FFHZFW2050 20 X 50MM WIDE FLAT ZINC PLATED HINGE
- FFHZFW2270 22 X 70MM WIDE FLAT ZINC PLATED HINGE
- FFHBFW3065 30 X 65MM WIDE FLAT BRASS INSET HINGE



FFHBC4035

FFHBF4035

FFH1110 (-10,-12,-16)

## NEW CRANKED HINGES

- Cranked hinges in brass.
- FFHBC4035 40 X 35MM CRANKED BRASS HINGE

## NEW CONCEALED BRASS HINGES

Neat hinge for inserting into end of door or flap. Length is overall of both halves of hinge.

- FFH1110-10 CONCEALED HINGE 10mm dia L=22mm
- FFH1110-12 CONCEALED HINGE 12mm dia L=28mm
- FFH1110-16 CONCEALED HINGE 16mm dia L=33mm



FFHBFW3065

FFCJTRIW

## NEW CORNER JOINTS

- FFCJTRIW TRIANGULAR CORNER JOINTS
- B6306GY CORNER JOINT DOUBLE - GREY

## NEW DOOR LATCHES

- DHCHR052 LIFT FLAP DOOR LATCH SATIN NICKEL
- DHCHR053 CATCH PLATE FOR DHCHR052



DHCHR052

B6306GY

## NEW PULL OUT WARDROBE RAIL

- FFPOWR260 260MM CLOSED 231 FIX CTRS 8KG MAX
- FFPOWR310 310MM CLOSED 281 FIX CTRS 6KG MAX
- FFPOWR360 360MM CLOSED 331 FIX CTRS 5KG MAX

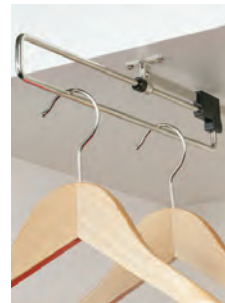

PULL OUT WARDROBE RAIL

## NEW SEAT BOX TOP HINGES

- 95 deg opening with 110mm forward movement to account for cushion top. built in stop prevents seat top from slamming. Counterbalance sprung version will hold max 8kg seat top open.
- FFSBTHSP SPRING SEATBOX TOP HINGES PAIR BURNISHED
  - FFSBTH SEATBOX TOP HINGES PAIR GALVANISED YELLOW



FFSBTH

FFSBTHSP

## HARDWOOD BED SLATS

- High strength beech slats as used by all the leading manufacturers.
- 53 X 8 mm profile.

- FBSL443 53 x 8mm slat 443 mm long
- FBSL585 53 x 8mm slat 585 mm long
- FBSL640 53 x 8mm slat 640 mm long
- FBSL991 53 x 8mm slat 991 mm long
- 100 x 12mm profile
- FBSL1372 100 x 12mm slat 1372 mm long

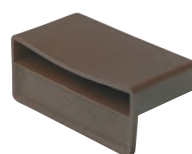

BED SLAT POCKETS



Hardwood bed slats

## NEW BED SLAT END POCKETS

- FBSLPK538 Slat pocket for 53 x 8 slats
- FBSLPK112 Slat pocket for 100 x 12 slats



Bar Handle 12mm diameter 156mm long M4 mounting holes @ 96mm centres. Steel handle with stainless steel effect finish. Requires M4 handle screws to suit board thickness **FFBH156**

Matt Nickel Finish Bow Handle 96mm hole centres, 141mm length, 29mm high & 20mm wide. **FFBWH141**

**NEW** Bow Handle 128mm hole centres, 168mm length, 30mm high & 22mm wide. AS USED ON OUR NEW COMPACT TIP UP SINK AND CABINET. **FFBWH168SS** STAINLESS STEEL EFFECT **FFBWH168PC** POLISHED CHROME FINISH

WE NOW OFFER INSTALLATION SERVICE IN KENILWORTH BY [SupremeTech.co.uk](http://SupremeTech.co.uk)

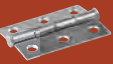

## NEW LIGHTWEIGHT FURNITURE BOARD

When fitting out the furniture for the interior you require quality panels that look good, are impact resistant, but do not add excessive weight. Our lightweight ilomba faced plywood decorated with a durable hard face laminate weigh only 20Kg per board (based on 8' x 4' 15mm sheets).

Furniture board is available in 8' x 4' sheets 15mm veneered both sides.

We also have a range of Furniture & shower / wall board veneered one side in various colours 8' x 4' & 7' x 4' sheets 3mm thick.

FINISH	3MM SINGLE SIDED	15MM DOUBLE SIDED
Puntinella	<b>FBD0384PUT</b>	<b>FBD1584PUT</b>
Titanium	<b>FBD0384TNM</b>	<b>FBD1584TNM</b>
Aluminium		
Walnut	<b>FBD0384WAL</b>	<b>FBD1584WAL</b>
Beech	<b>FBD0384BCH</b>	<b>FBD1584BCH</b>
Oak	<b>FBD0384OAK</b>	<b>FBD1584OAK</b>
Maple	<b>FBD0384MPL</b>	<b>FBD1584MPL</b>
Bright Grey	<b>FBD0384BRG</b>	<b>FBD1584BRG</b>
Carbon	<b>FBD0384CBN</b>	<b>FBD1584CBN</b>
Black Speckle	<b>FBD0384BSP</b>	<b>FBD1584BSP</b>
Grey Speckle	<b>FBD0384GSP</b>	<b>FBD1584GSP</b>
Cherry	<b>FBD0384CHY</b>	<b>FBD1584CHY</b>

## 3MM WALLBOARD SINGLE FACED

**FBD0384STL** 3mm Single sided Stella

## 3MM LIGHTWEIGHT PVC WALLBOARD

**FBD0384WHT** 3mm Lightweight White PVC wall board ideal for showers being totally waterproof & easy to clean

## KNOCK IN T SLOT EDGE & PROFILES (PER METRE)

T edging is installed into routed slot in edge of board to provide a neat finish in furniture construction.

<b>FBESLTBCH</b>	SINGLE LIPPED T BEECH EFFECT
<b>FBESLTDBRN</b>	SINGLE LIPPED T DARK BROWN
<b>FBESLTDGRY</b>	SINGLE LIPPED T DARK GREY
<b>FBESLTMGRY</b>	SINGLE LIPPED T MID GREY
<b>FBESLTSLV</b>	SINGLE LIPPED T SILVER

## LOCKER DOOR PROFILE (PER METRE)

Locker door edge profile with double lipped T.

<b>FBELDPMGRY</b>	LOCKER DOOR PROFILE MID GREY
<b>FBELDPSLV</b>	LOCKER DOOR PROFILE SILVER

## SOFT TABLE EDGE B PROFILE (PER METRE)

Soft T edging installed into routed slot in edge of board to make up table tops.

<b>FBESTEDGRY</b>	SOFT TABLE EDGE 'B' DARK GREY
<b>FBESTEMGRY</b>	SOFT TABLE EDGE 'B' MID GREY

## CORNER BOARD PROFILE (PER LENGTH)

Allows two board edges to neatly create a corner. Ideal for toilet shower room or wardrobes. Rigid profile with soft corner infill.

<b>FBECORNMGRY</b>	CORNER PROFILE MID GREY 2.2MTR
<b>FBECORNSLV</b>	CORNER PROFILE SILVER 2.2MTR

## WINNING POST SOFT TRIM (PER METRE)

Trim is pinned to edge of furniture where it comes into contact with shaped sidewalls to give a neat edge finish and take up any variances.

<b>FBEWPTWHT</b>	WINNING POST SOFT TRIM WHITE
<b>FBEWPTMGRY</b>	WINNING POST SOFT TRIM MID GREY
<b>FBEWPTBGE</b>	WINNING POST SOFT TRIM BEIGE

## WALL BOARD JOINT AND EDGE STRIP (PER LENGTH)

<b>FBWBEGTWHT</b>	WALL BOARD EDGE TRIM WHITE
<b>FBWBJNTWHT</b>	WALL BOARD MID JOINT WHITE

## NEW 6MM ARBOUR SLOTTOR TOOL

For grooving and milling of the slots for the T edging using a router with 6mm collet.

**FBRTSLT2** 2MM SLOTTOR CUTTER COMPLETE

## NEW IRON ON EDGING

Edging easily installed using a domestic iron. Iron on with paper slipped between iron and edging to protect surface while bonding the pre coated hot melt glue. Others available please check.

<b>FBEIRNBCH</b>	BEECH
<b>FBEIRNMPL</b>	MAPLE
<b>FBEIRNOAK</b>	OAK
<b>FBEIRNPNT</b>	PUNTINELLA
<b>FBEIRNWAL</b>	WALNUT
<b>FBEIRNCBN</b>	CARBON
<b>FBEIRNBSP</b>	BLACK SPECKLE
<b>FBEIRNGSP</b>	GREY SPECKLE



PRE GLUED IRON ON EDGING



Puntinella

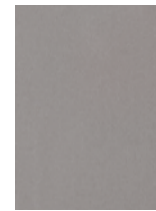

Titanium



Walnut



Beech



Oak



Maple



Bright Grey

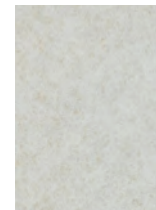

Stella Wallboard



Grey Speckle

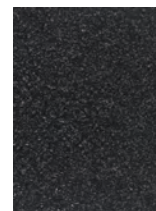

Black Speckle

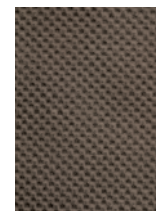

Carbon



Flexible Corner FBECRNFLX



Single lip T edge profile

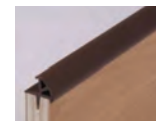

Locker door edge profile



Soft table edge



WINNING POST SOFT TRIM



Plywood 3,2 mm EDGE TRIM



MID JOINT

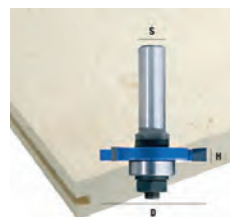

ROUTER SLOT CUTTER

**FBECRNMDF WRAPPED MDF CORNER PROFILE**  
Various matching Colours



CORNER BOARD PROFILE

We have various other matching edging, T sections and profiles. Please check for current stock availability.



0844 414 2324



0844 414 2425

# PUSH BUTTON DOOR CATCHES



## PUSH BUTTON DOOR LOCKS

Neat easy to fit push button lock. Press button to unlock, knob extends and door can be opened, Close door and push button until flush, catch clicks door is now locked and button stays Flush. When pressed home, the knob forms an attractive flush finish with the cupboard door. The push button lock is very easy to use and very reliable in operation.

The locks comprise of push-button lock case, rosette and push button. After locating the required lock position, a 26mm hole is drilled in the door. The push button lock case is fixed to the inside of the door by way of two screws through the casing tabs. The rosette is pushed Tight into the hole from outside, the knob is screwed on tight to the lock pin. The installation of just the push button lock case is suitable for all smaller cupboard and overhead locker doors. For larger doors such as wardrobes and toilet compartment doors the addition of a **hook rod set** is essential. This provides a three point locking set up to ensure the door is held tight. The three point locking will cut out the rattling of the door against the Frame, thereby making for a quieter journey.

## SINGLE SIDED PUSH BUTTON LOCKS

Single sided button for cupboards and overhead lockers, Lock kit includes lock case, knob, rosette and striking plate. For use on long doors wardrobes etc add a **Hook Rod Set**. To fit a Hook Rod Set add **H** to the end of the lock order code (i.e. **FPLSBH**) to order lock with locating holes, then order the quantity of Hook Rod Sets required below.

- FPLSB** BROWN BUTTON SINGLE PUSH-LOCK (BROWN LOCK CASE)
- FPLSD** GOLD BUTTON SINGLE PUSH-LOCK (BROWN LOCK CASE)
- FPLSN** MATT NICKEL BUTTON SINGLE PUSH-LOCK (BROWN LOCK CASE)
- FPLSW** WHITE BUTTON SINGLE PUSH-LOCK (WHITE LOCK CASE)

## DOUBLE SIDED PUSH BUTTON LOCKS

Double sided button for toilet/ bathroom where lock needs to be operated from both sides, for use on long doors add a Hook rod set. Kit includes: lock case, 1 x inner knob, 1x knob and rosette to colour and striking plate. The inner knob is supplied the same colour as the lock case.

- FPLDB** BROWN OUTSIDE BUTTON DOUBLE PUSH-LOCK (BROWN LOCK CASE)
- FPLDD** GOLD OUTSIDE BUTTON DOUBLE PUSH-LOCK (BROWN LOCK CASE)
- FPLDN** MATT NICKEL OUTSIDE BUTTON DOUBLE PUSH-LOCK (BROWN LOCK CASE)
- FPLDW** WHITE OUTSIDE BUTTON DOUBLE PUSH-LOCK (WHITE LOCK CASE)

## HOOK ROD SETS

Hook rods are added to provide 3 point locking of larger doors (wardrobes and washrooms etc.) to reduce vibration noise and secure door more firmly. Kit includes: 2 x catch hooks, 2 x 1000 mm rods with PVC over sleeve tubes and 2 x locking bolts. Rods and over sleeves can cut down to size.

- FPLHRB** HOOK ROD SET 2 x RODS + BROWN PVC OVER SLEEVE, 2 x LOCK BOLTS & CATCH HOOKS

## MINI PUSH BUTTON LOCKS

New mini single button push lock for small cupboards and overhead lockers

- FPLMD** GOLD BUTTON MINI PUSH-LOCK (BROWN LOCK CASE)
- FPLMN** MATT NICKEL BUTTON MINI PUSH-LOCK (BROWN LOCK CASE)

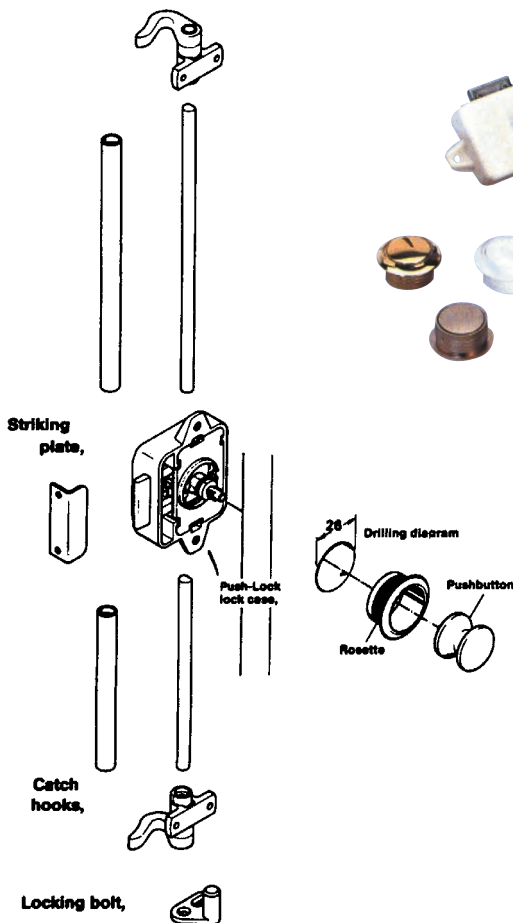
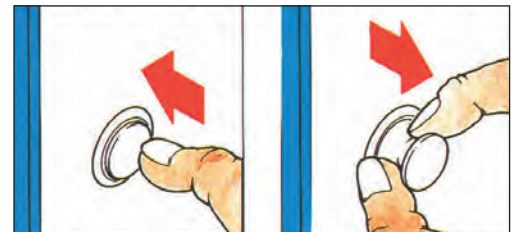
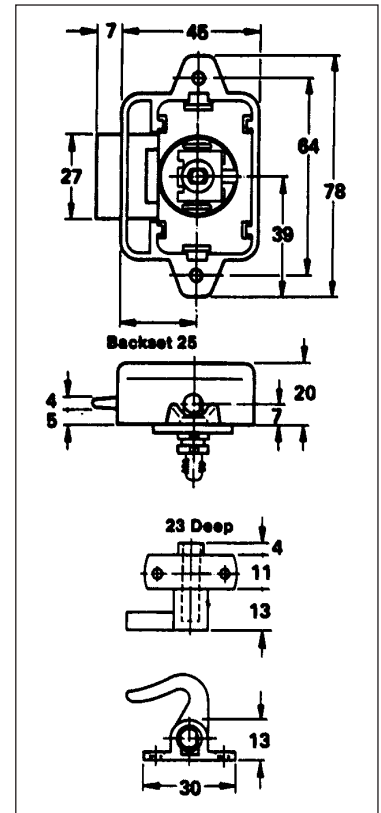
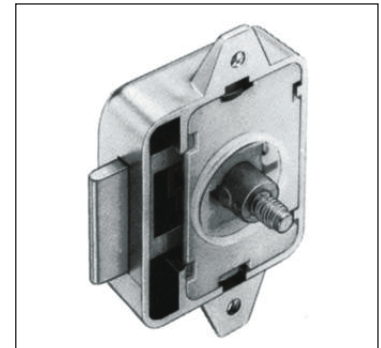

## NEW MINI PUSH-LOCKS

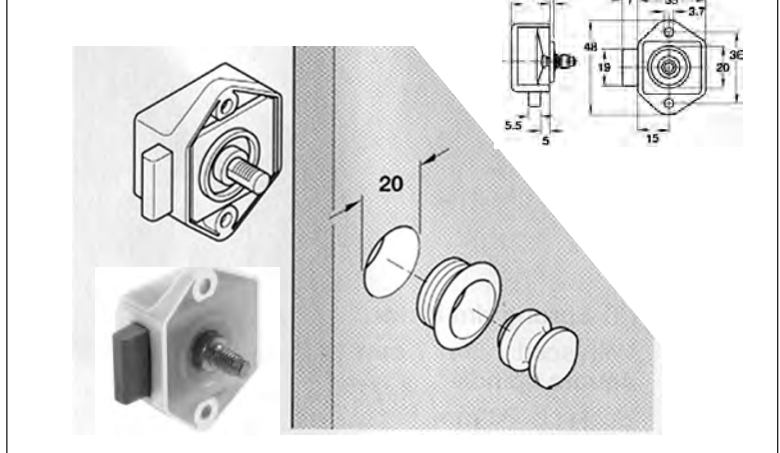

WE NOW OFFER INSTALLATION SERVICE IN KENILWORTH BY [SupremeTech.co.uk](http://SupremeTech.co.uk)

Furniture Fittings

Buy securely online at [Leisurelines.net](http://Leisurelines.net)



Use colour code after product code replace + with colour. Colours: BG = BEIGE, BR = BROWN, K = BLACK, W = WHITE, OW = CREAM.



Each door should be fitted with 2 silicone buffers to silence the closing action and eliminate vibration to protect the door and cabinet from damage.  
**FFSDB50** SILICONE DOOR BUFFERS PK 50



**FF6823..** Wardrobe rail support for 15mm tube



**B6832** ADJUSTABLE TURN BUTTON CATCH WHITE 25 – 45MM RATCHET ACTION LOCK

B6832 The adjustable turn button will retain a shower door or other objects between heights of 25mm x 45mm. The ratchet mechanism is similar that of a cable tie and once pushed down over the barbs will lock the retainer. To release the mechanism you simply turn the retainer 90 degree and slide the collar out, turn it 90 degree over the door and push down to ratchet and lock.



**FFRCSINW** SINGLE ROLLER CATCH WHITE



**FFMG1W** MAGNETIC CATCH WHITE  
**FFMG2B** MAGNETIC CATCH BROWN



**FPORPT**

**CARRIER BAG BIN HOLDER**

Wall mounting bracket to use shopping bags as a waste bin. Arms fold out for good access and fold closed to retain contents in bag. Fixed to wall or inside cupboard door by 2 screws. 300mm Long protrudes 15mm when closed.

**FPORPT** Plastic bag waste bin holder

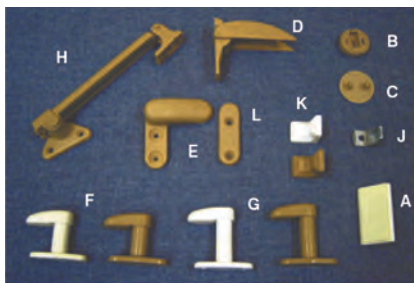

- A **B6306+** Corner joint double ( W, BG )
- B **B6308BG** round knock down panel fitting ( BG )
- C **B6309BG** round kd panel fitting cap ( BG )
- D **B6806+** sink top flap retainer ( BG, W )
- E **B6834BG** turn button catch ( BG )
- B6835BG** 10mm spacer for B6834BG
- L **B6836BG** Beige striker for B6834BG
- F **B6840+** collared turn button c/w base 26 mm ( BG, W )
- G **B6841+** collared turn button c/w base 35 mm ( BG, W )
- G **B6876+** collared turn button c/w base 45 mm ( BG, W )
- H **B6862BG** adjustable locker stay single ( BG only )
- J **B8043** 1 x 1 diecast zinc bracket pack of 10
- K **B8044+** 1 x 1 bracket cover pack of 10 ( BG W )



**FFRCW** Twin roller V catch white



**FFMLB** Mini Latch plated with brown keep

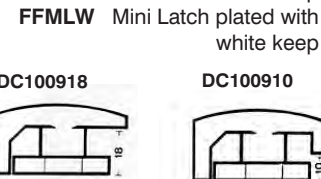

**FFMLW** Mini Latch plated with white keep

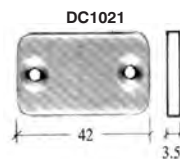
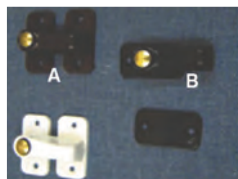

Turn buckle catches DC1005 shown with DC1021 dimensioned right, is a neat twist catch for retaining internal doors & flaps etc. Brown, Black & White.

A **DC1005** Turn buckle catch (BR, BK, W)  
B **DC1021** Plate for DC1005 catch (BR, BK, W)

Heavy duty turn buckle catch with support leg Black  
**DC100918** Turn buckle catch 18 mm  
**DC100910** Turn buckle catch 10 mm  
**DC1025** Plate for DC1009++ catch.



**DC719W** Sprung door catch ( W )

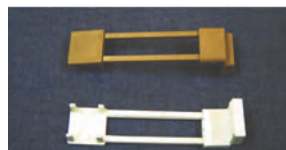

**B6804+** Adjustable sink flap retainer (BG, W )



**MAGAZINE NET**

A neat storage pocket for books & papers etc. 215 mm high x 315 mm wide.

Colour: Black  
**BMAGNT** MAGAZINE NET BLACK



**B6813+** Table stowage bracket (BG,G,OW,W)  
**B6814+** 5mm spacer for B6813 (BG,G,OW,W)  
**B6815+** 10mm spacer for B6813 (OW,)

Neat and effective press to open drawer catch  
**DH2029N** Slim drawer catch colour matt silver  
**DH2037** Catch plate for DH2029



**CONTINENTAL STYLE DOOR CATCHES**

Designed for installation in double faced lightweight ply for simple access doors. Square door catch for 45mm dia hole fits 12 to 20mm thick panel.

**DH105B** BROWN (A)  
**DH106G** GREY (B)

Profile 2000 Square door catch fits 50 X 50mm cut out for 15mm ply  
**DH430LG** LIGHT GREY (C)

WE NOW OFFER INSTALLATION & REPAIR SERVICE BY [SupremeTech.co.uk](http://SupremeTech.co.uk)



0844 414 2324



0844 414 2425

## BARKEEPER CUPBOARD CONTENTS RETAINERS

We have all experienced opening cupboards after traveling to have the contents fall out. Particularly cupboard above the hob where items falling out can easily break glass hob top or put a hole in the work surface. It happened to us so we came up with a solution.

New Barkeepers are designed to easily adjust to fit tightly any cupboard shelf to prevent the contents launching out at you when opening the door.

The Barkeepers come in several widths and coating finishes. They are easily and quickly adjusted to fit tightly into width or height of cupboard, while being easily removed to gain access. Simply squeeze adjustable tube together to release, rubber end caps ensure the Barkeeper grips securely into cupboard to retain contents.

Manufactured from Aluminium or Steel to ensure robustness & plastic coated in white or attractive wood effects.

### BARKEEPER

- FBK11300 BARKEEPER WHITE 25-44 cm
- FBK11310 BARKEEPER WHITE 41-71 cm
- FBK11400 BARKEEPER OAK 25-44 cm
- FBK11410 BARKEEPER OAK 41-71 cm
- FBK11500 BARKEEPER PINE 25-44 cm
- FBK11510 BARKEEPER PINE 41-71 cm

- FBK11321 BARKEEPER XXL ALU WHITE 48-80 cm



WHITE



OAK



PINE



## NEW TOP LOCKER DOOR SUPPORT STAYS

New high quality metal support stays for upward opening top locker doors. The stays function like car tailgate rams but use a compressed spring within its casting to support the door. The 150mm size is the most popular in the range. Larger sizes suit the larger overhead locker door.

- FTLSTM150 LOCKER STAY 150 mm MOST POPULAR SIZE
- FTLSTM200 LOCKER STAY 200 mm
- FTLSTM250 LOCKER STAY 250 mm

## TOP LOCKER DOOR SUPPORT STAYS

A SIMPLE SPRUNG STAY WITH ACETAL BODY. SPRING IS COMPRESSED BY ACTION OF OPENING OR CLOSING DOOR

- FTLSTP100 ACETAL SPRUNG LOCKER STAY 100 mm
- FTLSTP120 ACETAL SPRUNG LOCKER STAY 120 mm



FTLSTP100



FTLSTP120

## TOP LOCKER HINGE

Hinge specially designed for top locker doors. Hinge has built in sprung snap action to hold open locker door without the need for installation of side stays.

- FTLH1 Top Locker Hinge



FTLH1



FPORV8083

## SIMPLE LCD TV MOUNTS

Fixed TV mount slides onto wall bracket allowing easy stowing of TV if required. Max load = 10KG

- FPORV8082 LCDTV fixed wall mount
- FPORV8083 LCDTV swivel wall mount

- FPORV8082



Rear view showing wall mounted bracket, allowing easy removal from wall

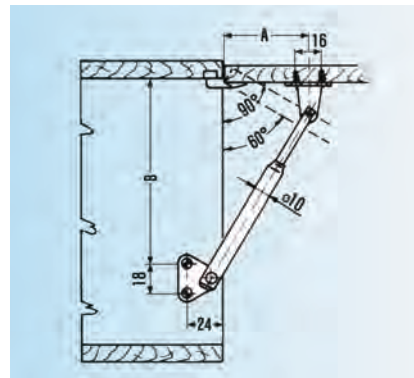

	mm 150	mm 200	mm 250
	60°	60°	60°
	90°	90°	90°
A mm	85	115	150
B mm	155	235	300
A mm	50	70	85
B mm	120	190	245

## TOP LOCKER GAS SPRING SUPPORT

Gas spring specially designed for top locker doors. Supplied with several alternative end knuckle fittings to suit optimum fitting position. Struts have force ratings (60N is 60 Newton's force) as printed to their side to identify load capacity. As used by many continental manufacturers.

- FTLS205460 60 Newton gas spring locker support stay
- FTLS205480 80 Newton gas spring locker support stay



FTLS205460

## NARROW SLIDE OUT LCD TV SUPPORT

New narrow slide out TV support is ideal to install in narrow cupboards. Support arm rotates and inclines to allow ideal positioning for viewing. Narrow design and rotating arm allows TV to be stowed narrow way into cupboard allowing more room for DVD, satellite, or Freeview boxes. Cassette slide extends 40cm. TV capacity 20kg.

- FPORV6101



## ADJUSTABLE LCD TV MOUNT

Friction hinge at base of arm. TV mounting plate on arm is adjustable in height. Arm length 270mm max. Universal LCD TV mounting plate adjustment -40mm.

Can be fitted to conventional TV swivel to upgrade to an LCD TV

- FPORVTL01



FPORVTL01

WE NOW OFFER INSTALLATION SERVICE BY [SupremeTech.co.uk](http://SupremeTech.co.uk)



## LCD TV / MONITOR WALL SLIDE MOUNT

New specially designed LCD slide out TV swivel. Mounting plate is made to international standard to be universal fit on LCD TV'S. High quality construction powder coated steel in light grey colour. 3 X High quality ball slide construction for smooth movement in and out. Safety catch locks unit in stowed position when TV support is pushed back into closed position.



## LCD TV / MONITOR SLIDE OUT SWIVEL

New specially designed LCD slide out TV swivel. Mounting plate is made to international standard to be universal fit on LCD TV'S. High quality construction powder coated steel in light grey colour. High quality ball slide construction for smooth movement in and out. Safety catch locks unit in stowed position when TV support is pushed back into closed position.



FPORTV6

FPORTV2/3



Our Lightweight TV mounting fixes to sidewall of TV cabinet or suitable wall surface. The telescopic multi leaf slide extends from 350mm to 800mm. This can easily be shortened by removing or shortening the runners. LCD TV mounting plate swivels all the way around to enable TV to be viewed from either side. Mounting also has vertical adjustment for angle of viewing. Manufactured from anodized Aluminium profiles for strength while being light in weight. **FPTV810** Telescopic LCD TV Mount for smaller LCD TV'S

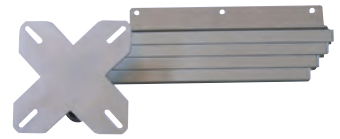

Not to be used extended while vehicle in motion.

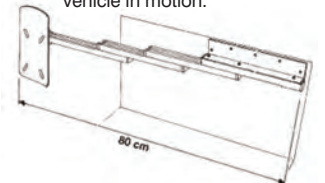

## TELEVISION / MONITOR SLIDE OUT SWIVEL

High quality ball slide construction for smooth movement in and out. Powder coated steel in light grey colour. Two sizes of extension are available. Safety catch locks unit in stowed position when TV support is pushed back into closed position. These TV swivels can be adapted to take LCD TV's. Dimensions A width, B depth closed, C depth open.

FPORTV3 A: 290 B: 300 C: 623 FPORTV2 A: 265 B: 250 C: 458

FPORTV3 TV swivel slide out 29 x 29 cm

FPORTV2 TV swivel slide out 25 x 26 cm

## TELEVISION / MONITOR SLIDE OUT SWIVEL SUPPORT

Sizes: 331 mm (13") wide, 330 mm (13") deep and extends 267 mm (10 1/2") approx. Colour finish: black plated.

FPORTV TV / monitor slide out swivel mechanism

## NEW UNDER CABINET FLIP DOWN LCD SCREEN MOUNT

Designed for LCD / TFT Screens up to 17" with either 50mm, 75mm or 100mm VESA® fixings, Max Screen Weight: 10Kg, Simple slide-out and flip-down action, 360° swivel and tilt function allow for optimum viewing, Max Screen size 17" (subject to space allowed), Pivot: 360 degree's, Tilt: +/- 15 degree's.

FPORTV7525W FLIP DOWN LCD SCREEN MOUNT WHITE

## NEW LCD TV / MONITOR MOUNTING BRACKET

LCD wall-mounting bracket mounts the screen only 20mm from the wall its ideal for wall mounting computer monitors in mobile offices, hospitality units and TV broadcast units. Screen size from 10" to 23" and weight up to 20Kg.

FPORTV7510K LCD FIXED WALL MOUNT BLACK

FPORTV7510SG LCD FIXED WALL MOUNT SILVER GREY

## NEW LCD TV / MONITOR TILTING WALL MOUNTING

This mount permits the wall-mounted installation of LCD TV'S in Motorhomes, Caravans & Specialist Vehicles. Screen size from 10" to 23" and weight up to 20Kg, mount has a tilt range of 17° (this may be limited due to the size of your screen) and mounts the screen only 55mm from the wall. Unique security screws with long hex key help prevent theft.

FPORTV7511K LCD TILTING WALL MOUNT BLACK

FPORTV7511SG LCD TILTING WALL MOUNT SILVER GREY

## NEW LCD TV / MONITOR WALL ARM MOUNT

New design LCD TV wall bracket. Mounting plate to fit LCD TV'S from 10" to 23" and weight up to 15Kg. Arm that allows the screen to be mounted only 75mm from the wall or extended up to 280mm. Two swivel points - one at wall for 180°, one at the screen of 240° & a tilt function of up to 17° (this may be limited due to the size of your screen).

FPORTV7512C SINGLE ARM MOUNT CHROME (LTD STOCK)

FPORTV7512K SINGLE ARM MOUNT BLACK

## NEW SWING OUT LONG TWIN ARM LCD MOUNT

Designed for LCD Screens from 10" to 23" and weight up to 15Kg. The twin arm design allows full flexibility, it can mount the screen flat to the wall or extend out to up to 450mm from the wall. 3swivel points - one at the wall for 180°, one in the middle of 240° and one at the screen of 240° also has a tilt function of up to +/- 17°.

FPORTV7513K TWIN ARM MOUNT BLACK

## NEW LCD TV / MONITOR PIVOT WALL MOUNTING

Pivoting wall mount for screen size from 10" to 23" and weight up to 20Kg, mount has a tilt range of 17° & 180° swivel (subject to size of screen) and mounts the screen only 95mm from the wall.

FPORTV7518K LCD PIVOT WALL MOUNT BLACK

FPORTV7518SG LCD PIVOT WALL MOUNT SILVER GREY

## LCD TV / MONITOR SWING DOWN CEILING MOUNT

New design LCD TV swing down bracket with lock to stow TV up at ceiling. Mounting plate is made to international standard to be universal fit on LCD TV'S. High quality powder coated steel in light grey colour.

FPORTV13 LCD TV ceiling mount

FPORTV7525W

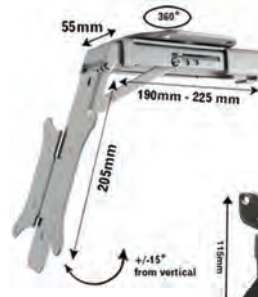

FPORTV

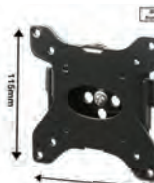

FPORTV7510

FPORTV7525W

FPORTV7511



FPORTV7512

FPORTV7518



FPORTV7513



FPORTV13

SEE NEXT PAGE FOR MORE TV MOUNTS

WE NOW OFFER INSTALLATION & REPAIR SERVICE BY [SupremeTech.co.uk](http://SupremeTech.co.uk)



0844 414 2324



0844 414 2425



# TABLES FITTINGS AND ACCESSORIES



Buy securely online at Leisurelines.net Furniture Fittings - Tables

## NEW FOLDING SHELF SUPPORT

Our new simple but effective shelf support is high on performance and low on cost. Available in 3 sizes and 2 colours. Simple locking and folding action provides an easy to use strong and effective support to add worktop extensions or small tables. Size A open. Size B closed 35 mm.

- FSS6200BR** Folding shelf support 200mm brown
- FSS6200BL** Folding shelf support 200mm black
- FSS6300BR** Folding shelf support 300mm brown
- FSS6300BL** Folding shelf support 300mm black
- FSS6400BR** Folding shelf support 400mm brown
- FSS6400BL** Folding shelf support 400mm black

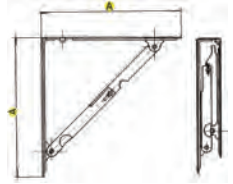

## NEW SELF LOCKING SHELF SUPPORT

New automatic locking shelf support, lift up and it clicks into position. To lower just lift the front lever to release lock and lower it down.

- FSB1851BL** 185mm Self Locking Shelf Support
- FSB2852BL** 285mm Self Locking Shelf Support
- FSB3403BL** 340mm Self Locking Shelf Support

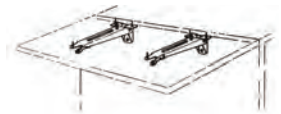

185

## SWING OUT FLAP SUPPORT

**B6302BG** Swing out, flap support bracket

## TABLE HOOK

Nylon fitting allowing one end of small tables to be attached to wall. Table will also require a table leg. Colour available BR= Brown

**TF3001BR** Neat and effective table hook.



100

60  
**TF3001BR**

**B6302BG**

## FOLDING FLAP/ SHELF SUPPORTS

The new supports for drop leaf shelves provide valuable worktop space. While being easily folded away.

- TSMN345** 345 mm folding flap support mechanism
- TSMN445** 445 mm folding flap support mechanism
- TSMN8098** Heavy duty folding shelf support
- TSMN30500** Very strong 3 part folding support mechanism

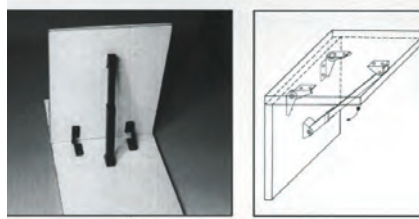

**TSMN30500**



**TSMN445**



**TSMN345**



**TSMN8098**

## FOLDING SPRUNG FLAP SUPPORTS.

Easy to operate spring lock location of support arm. Made from strong pressed steel, zinc plated and passivated.

- TSMN250** 250mm folding sprung flap support mechanism
- TSMN380** 380mm long folding flap support

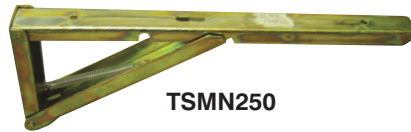

**TSMN250**

Simple version PMT allows table to be rotated 360 degrees and locked in position. The top allows table to be slid long ways 25cm and width ways 14cm. Black coated steel.



## FIXED POLE HEAVY DUTY TABLE SUPPORT

Fixed table support is manufactured from a zinc plated core with an outer grey plastic tubular cover for a smart installed appearance. Fixed table height 720mm.

Available with version PMT sliding top frame.

**TSL612400PMT** Fixed table support top version PMT



**TVSV5**



**TSL612400PMT**

## NEW LCD TV WALL MOUNTS

The Svensen **TVSV5** Quick Release Wall Mount is a secure mounting point for your flat screen television. The mount supports 10" to 23" screens up to 25Kgs.

## NEW UNDERSHELF TV MOUNT

The Svensen **TVSV6** Undershelf Bracket is a sturdy, easy to install mount for your LCD or LED TV. Its fold-away arm conceals the display beneath your cabinet until you want to use it. An integrated swivel mount allows you to rotate the screen for easy viewing from any angle.

## NEW ADJUSTABLE SWING ARM TV MOUNTS

The Svensen Adjustable Swing Arm is a sturdy, easy to install mount for your LCD or LED TV. A built-in spirit level and simple 3-point wall mounting makes fitting the arm easy

- TVSV7** Short Adjustable Swing Arm
- TVSV8** Single Adjustable Swing Arm
- TVSV9** Double Adjustable Swing Arm

**TVSV7**



**TVSV8**



**TVSV9**



## LCD TV / MONITOR MOUNTING BRACKET

Our LCD wall-mounting bracket permits the wall-mounted installation of LCD TV'S in Motorhomes, Caravans & Specialist Vehicles. It is ideal for wall mounting computer monitors in mobile offices, hospitality units and TV broadcast units.

**FPORTVL** LCD TV wall mounting bracket

Swing out arm LCD TV mount. Swing out has lock points at stowed and 90 degree open, additional positions can be cut into runner for precise positioning. Dual direction adjustment on LCD TV mounting plate. Fixing bracket 180mm H x 80mm. Arm pivot 220mm centres.

**FPORTV09** Swing out arm LCD TV wall mount



**FPORTVL**



**FPORTV09**

WE NOW OFFER INSTALLATION SERVICE BY [SupremeTech.co.uk](http://SupremeTech.co.uk)



[www.caktanks.com](http://www.caktanks.com)



[sales@caktanks.co.uk](mailto:sales@caktanks.co.uk)





**TSCNAUT**

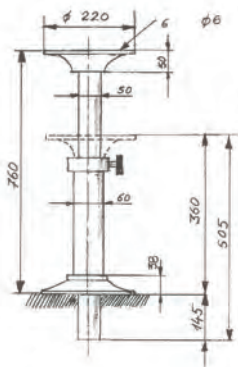

## TELESCOPIC ISLAND TABLE POLE

New smart & stylish table support raises and lowers to suit height required. Strong marine grade castings top and bottom for strength. Matt anodised aluminium pole provides a quality finish to the leg. Table can be positioned at any height with the clamp knob. The mounting bases are 220mm Ø with recessed fixing holes providing a very sturdy table. The table pole has a maximum height of 760mm. Its height with the pole retracted to touch floor surface is 500mm. The table pole is designed to retract into a hole through the floor, where it is fitted with this hole the pole will retract to 362mm high, the pole will project through the floor 138mm.

**TSCNAUT TELESCOPIC ISLAND TABLE POLE**

## FREE STANDING LOWERING TABLE FRAME

Complete portable freestanding table support with height adjusting Folding action. This enables the table to be used as a normal height Dining table or lowered to support a bed or act as a coffee table. Being completely portable it can also be used outside. (Colour brown) New narrow version 620mm wide for the smaller conversion space. Max height 655-> 695mm, minimum height 300 -> 340mm.

**TSFSARB62** Free standing lowering table frame 620mm wide  
**TSFSARB76** Free standing lowering table frame 760mm wide

## TELESCOPIC ELECTRICALLY OPERATED TABLE SUPPORT

Telescopic table support is manufactured in steel with a stylish moulded plastic nesting skirt to hide mechanism. The table is powered by a 12v electric actuator controlled by remote wall switch which is supplied in kit. Table support is supplied complete with 2 way sliding mechanism for precise positioning of table top. (Table top is not supplied only fitted for photo demonstration) Height of leg max 720mm min 330mm

**TSE612300TA** Telescopic electric table support grey top A  
**TSE612300TB** Telescopic electric table support grey top B width ways.

## TELESCOPIC GAS STRUT OPERATED TABLE SUPPORT

Telescopic table support is designed to automatically raise from low to high by the press of the foot operated button on the floor base. Table locks in upper position until foot operated button is pressed to release lock. Hole in floor 100mm dia by 40mm deep for base of mechanism to fit into floor. Max frame height 765mm min height 345mm.

**TSM612500TA** Gas strut operated table support top version A  
**TSM612500TB** Gas strut operated table support top version B

**TSM612500**



**TSM612300 IN LOWERED POSITION**

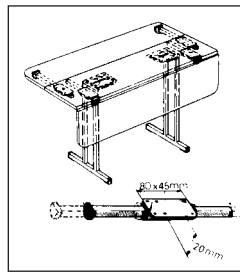

**TSFSARB76**

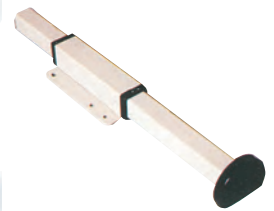

**TSCR**

**TS2000**



## HOOK 'N' LOCK 2000 TABLE FIXING PROFILE

New variation on hook n' lock with aluminium profile fixed to wall and clip on moulded ABS table plate (black) with locking location catch.

**TS2000 Profiled aluminium table wall mounting bracket**

## MULTI POSITION OFFSET SWIVEL TABLE LEG

Designed to fix into wall mounted clamp bracket, table fixed to top swivel plate locking clamp locks table in any position. The right-angled leg is made from 35mm dia tube & is fully removable for extra space. Table is widely used on German campers. The leg is available Zinc plated only.

**TSSVGIR** Multi position offset swivel table leg complete

**TSSVGFB** Spare floor bracket for offset swivel table leg

**TSSVGWC** Spare wall clamp for offset swivel table leg

**TSSVGT** Spare table top mounting plate

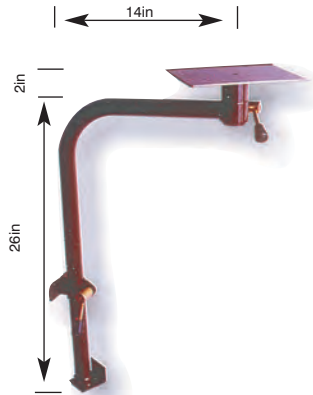

**TSSVGIR**

## SLIDING SUPPORTS FOR DROP LEAF TABLE TOPS

The sliding supports allow drop leaf tables to be used, freeing up valuable storage space. Can also be fitted inside a cupboard to pull out and support a fold over worktop.

**TSCR250** 250 mm sliding support 150 mm of slide  
**TSCR300** 300 mm sliding support 200 mm of slide  
**TSCR350** 350 mm sliding support 250 mm of slide

## HIGH SPEC FIXED, MANUAL & ELECTRIC TABLE SUPPORTS

Top slides pictured below are only supplied as part of the table kits left.

## TABLE SLIDE TOP FRAME VERSIONS

Traversing positioning slide frame can be locked in any position it is slid to by means of tightening clamp levers on the slides. Available in 2 versions.

**Version A** allows table to be located on centre plate in 4 positions before it is bolted on. High quality aluminium slide rails allow positioning of table with ease. The slide mechanism allows 0 - 36cm slide able long ways and 0 to 17cm slide able width ways.

**Version B** allows table to be rotated fully 360 degrees and used in any positions by means of a swivel plate mechanism similar to a set swivel plate. It is lockable in 4 positions. High quality aluminium slide rails also allow positioning of table with ease. The slide mechanism allows 0 - 36cm slide able long ways and 0 to 17cm slide able width ways.



**Version A**

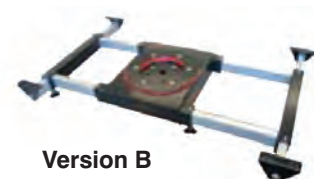

**Version B**

WE NOW OFFER INSTALLATION SERVICE BY [SupremeTech.co.uk](http://SupremeTech.co.uk)



0844 414 2324



0844 414 2425



# TABLE FITTINGS & ACCESSORIES



Buy securely online at [Leisurelines.net](http://Leisurelines.net) Furniture Fittings - Tables

## THE HOOK N' LOCK TABLE WALL SLIDE BAR.

LOCKED TRAVELLING POSITION

OPTIONAL POSITIONS

DISMOUNTED

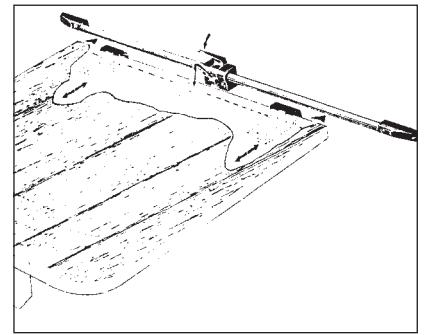
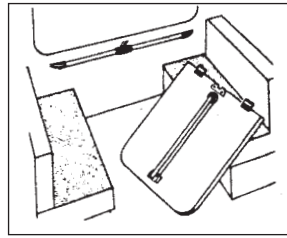
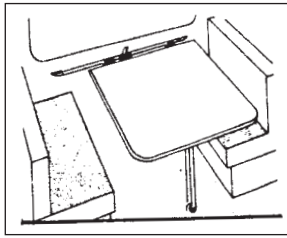
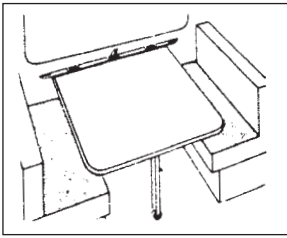

The hook n' lock is designed to firmly fix table to sidewall, while allowing lateral movement when unlocked, to make access to bed boxes easier, simply press down on central lock arm to release lock and slide table away without disturbing items on top of the table. Designed to complement our swing n' lock folding table leg to make up table. Securely anchors table for traveling and use while allowing the flexibility of position.

- TS950** Hook n' lock table slide bar 950mm long kit
- TSTBK** Spare set of table fixings to add alternative table to hook n' lock

## ISLAND LEGS

Range of island table legs and fittings to make strong tables. Tabletop can be used and fitted 360 degrees. A single leg will suffice for tables up to 20 inches square. For the larger table 20 x 24 inches upwards a pair of legs must be used. Available as individual components or as sets see price list for details. Colour options: Add B to end of code for Brown, BL for Black & C for chrome legs and polished aluminium bases. . Stainless Steel 700mm legs only available as sets, 355mm leg sold singly.

- TSL14SS** Island table leg 14" (355mm) (STAINLESS ONLY) For bed support
- TSL26** Island table leg 26" (660mm)
- TSL28** Island table leg 28" (710mm) (700mm Chrome)
- TSBAF** Above floor base
- TSBRC** Recessed base
- TSSET26B** Set of 660mm 26" island leg, above floor & recessed base BROWN
- TSSET28B** Set of 710mm 28" island leg, above floor & recessed base BROWN
- TSSET26BL** Set of 660mm 26" island leg, above floor & recessed base BLACK
- TSSET28BL** Set of 710mm 28" island leg, above floor & recessed base BLACK
- TSSET28C** Set of 700mm 27 1/2" CHROME island leg, above floor & recessed base
- TSSET28SS** Set of 700mm 28" Stainless Steel island leg, H Duty Cast Ali above floor & recessed base
- HTC200B** 51mm Island leg storage spring clip black coated



TS950

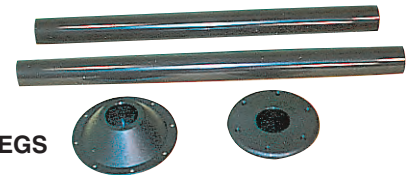

ISLAND LEGS

## SWING N' LOCK FOLDING TABLE LEG

Robust folding table leg can be used in many applications used in pairs to make a free standing table or use with hook n' lock table slide to make variable position table.

Colour options: Add B to end of code for Brown or add G for Grey or SS for Silver Sand

- TSLF26-** Swing n' lock folding table leg 660 mm
- TSLF28-** Swing n' lock folding table leg 710 mm

## LIGHTWEIGHT FOLDING TABLE LEGS

High quality oval aluminium tube table legs. Lightweight and strong modern design. Innovative knuckle hinge for strength and reliability. 50mm x 25mm oval tube 715mm high. Kneeling height 325mm is used to make up bed base. New version with base bar to add further stability to tables over 600mm wide

- TS8350B** Kneeling half folding table leg brown
- TS8350G** Kneeling half folding table leg grey
- TS8376G** Kneeling half folding + base bar table leg grey
- TS8050B** Full folding table leg brown
- TS8050G** Full folding table leg grey
- TS8376G** Full folding table leg black + base bar with wheels for easy Movement of table along Hook N' Lock or TS2000 table bar.

SWING 'N' LOCK

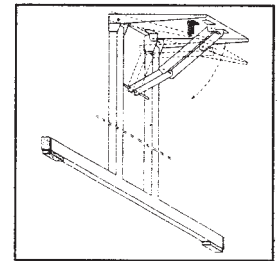

SWING 'N' LOCK

## BIFOLD N' LOCK FOLDING TABLE LEG

Robust BI folding table leg can be used in many applications used in pairs to make a free standing table or use with hook n' lock table slide to make variable position table. Leg when folded reduces in size in a scissor action to allow smaller table tops and reduced storage space requirements Colour Black.

- TSLF650K** Bifold n' lock folding table leg 650 mm



TS8050 TS8350 LIGHTWEIGHT FOLDING TABLE LEGS

TS8376

WE NOW OFFER INSTALLATION SERVICE IN KENILWORTH BY [SupremeTech.co.uk](http://SupremeTech.co.uk)





## HIGH TENSILE BOLT PACK FXHTBP

High tensile steel bolts all popular sizes supplied in portable carry case. M5X12, M5 X20, M6X30, M6X40, M6X50, M8X30, M8X50, M8X60, M10X30 & M10X70 (145pce approx)

## HEX NUT PACK FXHXNP

1000 hex nuts sizes: M3, M4, M5, M6, M8, M10 & M12 in a portable carry case.

## WASHER PACK FXWSHP

1000 Washers SIZES: M3X0.5X7.0mm, M4X0.8X8.0mm, M5X1.0X10mm, M6X1X13mm, M8X1X16mm, M10X1.2X19mm, M12X1.6X23mm M6 flexible, M8 flexible, M6X1.6X25mm, M8X1.6X32mm all in a neat portable carry case.

## A2 STAINLESS SELF TAPPER PACK FXSSTP

Stainless steel countersink PZD self tapping screws in portable carry case. Sizes: 4x $\frac{3}{8}$ ", 4x $\frac{1}{2}$ ", 4x $\frac{3}{4}$ ", 6x $\frac{1}{2}$ ", 6x $\frac{3}{4}$ ", 6x $\frac{1}{2}$ " 6x1", 6x $\frac{1}{4}$ ", 8x12, 8 x 1 $\frac{1}{4}$ ", 8x1 $\frac{1}{2}$ " (570pce approx)

## HI TECH SUPER GREASE (White grease)

Lubricates anything, Wood, Metal, or plastic, Outlasts normal grease or oil, Water resistant, Corrosion resistant, Great for hinges and lock mechanisms.

**PS3283** Hi Tech Super Grease Aerosol 200ml

## SUPER MAINTENANCE SPRAY

Maintenance spray Disperses Moisture, Lubricates, Penetrates, Cleans & Protects

**PS10483** Super Maintenance Spray Aerosol 300ml

## SPRAY ADHESIVE

Exceedingly strong glue in a handy 500ML aerosol form for easy application. Ideal impact adhesive for Veneers, Laminates, Interior trim, Insulation, Foam, Carpeting etc.

**FXSPYG5** HEAVY DUTY SPRAY ADHESIVE 500ML AEROSOL

## BUTYL SEALANT PREFORMED

Butyl sealant is a high quality non setting sealant used for a variety of joints in caravans and motorhomes. It is preformed to shape for ease of application to the sealing job at hand. Various sizes [profiles and colours available.

**SEBSTR...** Butyl sealing tape on the roll.

## NEW T-NUTS FOR WOOD

T-Nuts provide a strong, reliable and easy to fix low-cost anchor for wood and chipboard. The installation of T-Nuts is quick and easy to do - you simply place.

**FFTNU5** M5 THREADED T NUT FOR WOOD

**FFTNU6** M6 THREADED T NUT FOR WOOD

**FFTNU8** M8 THREADED T NUT FOR WOOD

## SIKA CLEANERS AND PRIMERS

Sika 208 cleaner for tools Removes uncured Sikaflex Technique sealants from Glass, metal brushes and tools. SIKA208C250 250ml aluminium flask. SIKA208C1L 1 Litre

**Sika Primer** - 206GP is a black, UV Blocking, moisture curing liquid primer, specially formulated for the treatment of glass & transparent GRP bond faces in direct glazing work, prior to application of Sika polyurethane direct glazing adhesives. It is also used on areas of bare metal to prime and inhibit corrosion for the bond surface.

**SIKA206GP250** 250ml aluminium flask.

**SIKA206GP1L** 1Litre aluminium flask

**Sika Cleaner** - 205 is an alcoholic solution containing a bond-activating substance for cleaning and activating bond faces prior to bonding. **SIKA205**

**Sika Aktivator** is a cleansing and activating agent specifically designed to clean and give improved adhesion. **SIKAAKTIV**

## SILICONE SEALANT

White high modulus silicone sealant used for sealing shower rooms, bathroom plastics, vents, rooflights, heater flue terminals, with fungicide for kitchen and shower room

Clear high-grade product we use in production when installing slide valves, gauges and hatches or other accessories to Water tanks.

Size 300ml cartridge.

**SIL310C** SILICONE SEALANT (CLEAR)

**SIL310W** SILICONE SEALANT (WHITE)

## ADHESIVE SEALANT

### SIKAFLEX 221

Single part polyurethane adhesive sealant. The professionals choice. Use to bond on roofs, panels, battens, doors, anything requiring bonding or sealing to anything else. Widely used on solar panel installations. All directly bonded windows and windscreens use Sikaflex. Full bond after a few hours, flexible & resistant to aging and weathering, over-paintable gives a very strong bond. Manufactured to ISO 9001 quality by SIKA. Available in Black, Grey & White. For externally visual fixing/sealing use 512 white. size 300ml cartridge.

**SIKA221B** SIKAFLEX 221 ADHESIVE SEALANT (BLACK)

**SIKA221G** SIKAFLEX 221 ADHESIVE SEALANT (GREY)

**SIKA221W** SIKAFLEX 221 ADHESIVE SEALANT (WHITE)



**SIKA710B** SIKALASTOMER-710 BUTYL SEALANT (BLACK)

**SIKA710G** SIKALASTOMER-710 BUTYL SEALANT (GREY)

**SIKA710W** SIKALASTOMER-710 BUTYL SEALANT (WHITE)

## ADHESIVE SEALANT SIKAFLEX 512 CARAVAN

A new sealant with all the qualities you would expect from a Sika product. Specially formulated for the sealing of joints, cappings and the installation of accessories on caravans. UV stable non yellowing formulation ensures visible sealant on joints stays white. Very similar properties to 221 but improved bond strength and cure times. Manufactured to ISO 9001 quality by SIKA. C.A.K. highly recommends this product.

**SIKA512CVN** SIKAFLEX 512 CARAVAN ADHESIVE SEALANT (WHITE)

## BUTYL SEALANT SIKALASTOMER

Sikalastomer 710 butyl sealant is a high quality non setting sealant used for a variety of joints in caravans and motorhomes. It is especially suitable for those situations where there is the possibility of future disassembly, such as edge trim on motorhomes, caravans and boats, windows, rooflights and airvents etc. Due to its very sticky non-setting flexibility it is ideal for re-sealing of edge trims that have been sealed with ordinary non-setting mastics which dry out. Available in black, grey & white, size 300ml cartridge.



**SEBSTR**



**FXSPYG5**



**T NUT**



**Sika Primer** - 209 is a black pigmented liquid of low viscosity. It is used to prime painted surfaces and plastic substrates (GRP ABS Polycarbonate ) prior to bonding with Sikaflex products. **SIKA209P250**

WE NOW OFFER INSTALLATION SERVICE BY [SupremeTech.co.uk](http://SupremeTech.co.uk)



0844 414 2324



0844 414 2425



### WALL & CEILING LINING CARPET

Special automotive carpet perfect for walls and ceilings. Widely used in the fitting out of Motorhomes, Campervans, Coaches, Minibuses, Horseboxes and Boats. Easily applied with hi-temp spray glue or brush able contact adhesive.

### STANDARD LINING CARPET

Available 2mtrs wide and around 4mm thick sold per linear metre or per 30m roll. The following colours are in stock. Other colours are available from time to time.

- ILC9965 Standard lining carpet Beige
- ILC2275 Standard lining carpet Arctic Blue
- ILC1527 Standard lining carpet Light Grey

### NEW HI-FLEX VELOUR LINING CARPET

Hi-flex velour highly flexible lining carpet. Designed to be extra flexible to fit around intricate shapes and be worked into the curves of the body structure without cutting in most situations.

Roll width 2.04m, approx 4mm thick. Sold per linear metre or per 30mtr roll. Other colours are available from time to time.

- ILCHFANT Hi-Flex velour anthracite
- ILCHFSLV Hi-Flex velour Silver
- ILCHFWE Hi-Flex velour Wheat

### NEW METALLIC CARBON BRUSHED EFFECT LINING VINYL

Carbon or brushed Metallic Effect Vinyl leatherette. Sold per linear metre or per roll. 137cm Wide 25Mtr roll. Other colours available.

- ILFMVCSIL Carbon Silver
- ILFMVCGRY Carbon Grey
- ILFMVBRSL Brushed Silver

### NEW SYNTHETIC LEATHER

Synthetic leather with p/e-knitted backing  
Sold per linear metre or per roll. Other colours available. 140CM WIDE 40MTR ROLL

- ILFGLD610 Light grey Synthetic Leather

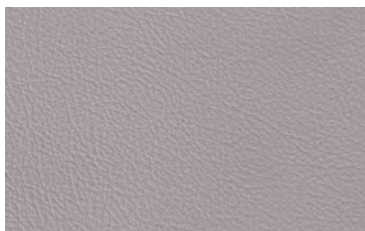

610 – Light grey

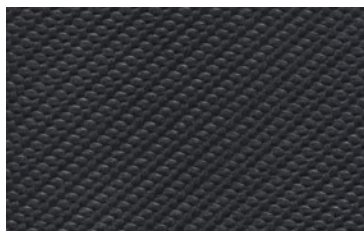

Carbon Grey



Brushed Silver

### NEW FLEXIBLE VELVET

Flexible/formable velvet fabric. Sold per linear metre or per roll. 140CM WIDE 30MTR ROLL  
Other colours available.

- ILFSIB722 Light grey Flexible Velvet



722 – Light grey

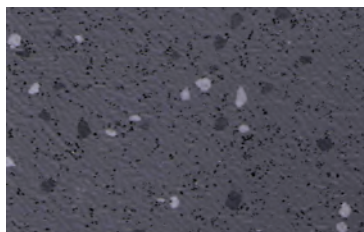

Eco Plus Rain Cloud

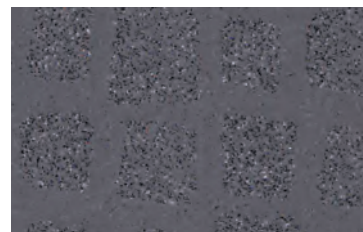

Centurion Grey Vinyl

### NEW VINYL FOORING

Hard wearing anti slip heavy duty vinyl flooring in a range of attractive colours and styles. Sold per linear metre or full rolls. Other colours and styles available from time to time.

- IVFC97894 CENTURION Grey with random 'cobble' design roll width 200cm length 12.5m. Sold per linear metre.
- IVFOS8401 ONESTEP Light Grey with random spotted effect roll width 200cm length 12.5m. Sold per linear metre.
- IVFOS8433 ONESTEP Sand with random spotted effect roll width 200cm length 12.5m. Sold per linear metre.
- IVFEPRNCD ECOPLUS Rain Cloud plain grey with random PVC flashing roll width 200cm length 15m. Sold per linear metre.

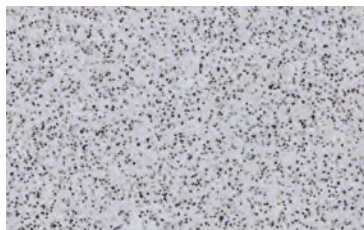

OneStep Light Grey Vinyl

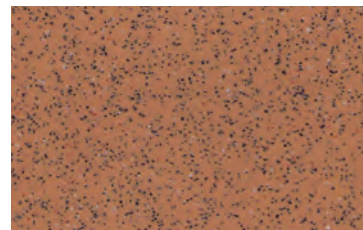

OneStep Sand Vinyl



Light Grey



Arctic Blue



Beige

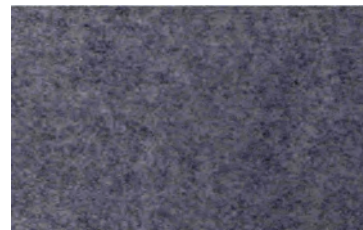

Hi-Flex Silver

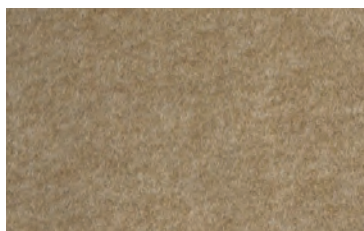

Hi-Flex Wheat

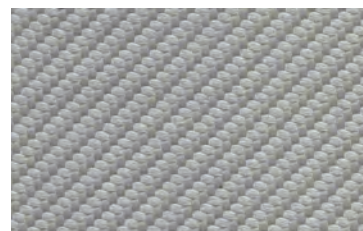

Carbon Silver

The photographs printed in this catalogue, may not accurately reproduce the tone/colour of each material. We cannot guarantee that different batches of the same material will be identical in colour so ensure you order sufficient material to complete your project

## CURTAIN RAIL AND ACCESSORIES

Standard Caravan and Motorhome curtain rail sold by the metre. Maximum single carriage. Made from tough but flexible uPVC.

- FCTRCB** CURTAIN RAIL BROWN PER METRE (A)
- FCTRCW** CURTAIN RAIL WHITE PER METRE (B)
- FCTRCEND** CURTAIN RAIL END STOP PACK 2 (C)
- FCTRCGL** CURTAIN RAIL GLIDER PACK 25 (D)
- FCTRCHK** CURTAIN RAIL CURTAIN HOOK PACK 25 (E)

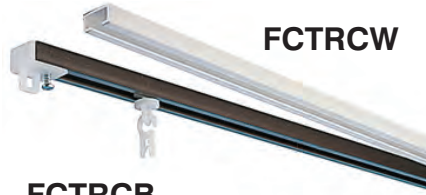

## ACRYLIC MIRROR TILE

Acrylic Mirror is a high quality plastic mirror sheet with tough protective back coating. Mirror grade Acrylic is 100 times stronger than glass but more lightweight, up to half the weight of an average glass panel, making it ideal for Caravan Motorhome and Marine applications. Supplied in A4 tiles 297 x 210mm for ease of installation, they are easily fastened by using double sided foam sticky pads. If you wish it can be easily drilled for screw fixing or cut to size using a fine tooth hacksaw.

**FFAMTA4** acrylic mirror tile silver



**FFAMTA4**

## ALUMINIUM CURTAIN RAIL

White coated aluminium curtain track Track comes pre-packed in 2 metre length with 2 end stops and 32 gliders.

**FCTACT382** 2m pack Aluminium curtain track

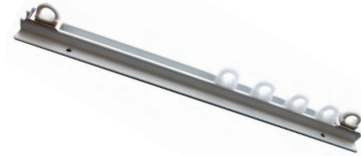

**FCTACT382**

## SECURON INERTIA REEL SEAT BELTS

500 series is a Lap & Diagonal 4 point mounting belt with Emergency Locking Retractor (ELR). Kits available in various buckle lengths and connections. 500 Series webbing length: Automatic Retractor to end Bracket 291cm. Retractor Angle: vertical. Dimensions are approximate and are from the centre of anchorage holes/mouths of buckles.

- SSB500-15** Inertia reel seat belt kit with 15cm metal strap buckle
- SSB500-30** Inertia reel seat belt kit with 30cm stalk/cable buckle
- SSB500-45** Inertia reel seat belt kit with 45cm stalk/cable buckle

- Webbing should pass across bone structure (the lap or centre of the shoulder).
- On lap and diagonal belts the buckle should lie just on or below the hip.
- There should be no slack webbing when the Seat Belt/Harness is worn.
- Where the Retractor has a pendulum (vehicle sensitive), the retractor angle is specific.
- These are complete Seat Belts/Harnesses - old/new parts should not be mixed.

Please note: these belts must be installed in accordance with the manufacturer's guidelines.



**SSB500**



**FCTACT382**



**SSB500**

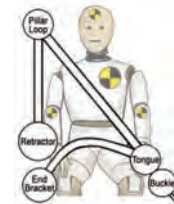

**SSB500**

## DOOR CURTAIN

Chenille type deluxe door curtain prevents insects and flies coming in through entrance door whilst it is open. Suitable for caravans, motorhomes, horseboxes, Narrowboats, catering units etc Can be easily trimmed to size in width by shortening header and removing strands, length by shortening strands.

Size 600mm wide x 1910mm deep

- DFCURTGW** DOOR CURTAIN GREY AND WHITE STRANDS
- DFCURTBL** DOOR CURTAIN BLUE AND GREY STRANDS
- DFCURTBG** DOOR CURTAIN BROWN AND GREY STRANDS
- DFCURTGY** DOOR CURTAIN GREY AND YELLOW STRANDS



## ROCK N' ROLL SEAT BED MECHANISM

Zinc plated hinge mechanism providing simple fold down action to turn dinette into double bed. Not suitable for modification to original driver & passenger front seats. Heavy duty construction zinc galvanised finish.

The sized drawings are given as a starting guide only. There are many variations in the way the hinge set can be installed to suit the intended usage.

**RNRHNG3** Rock n' Roll hinge handed pair.

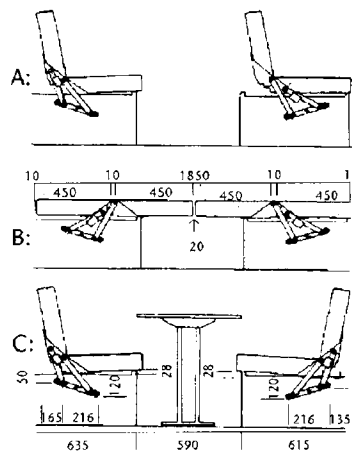
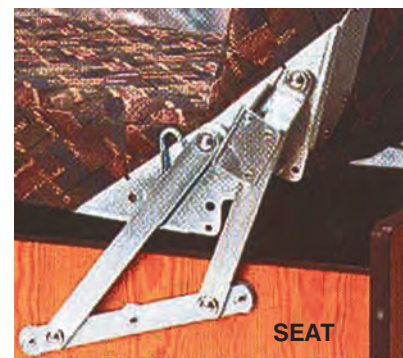

**A - TRAVELLING POSITION**  
**B - BED POSITION**  
**C - DINING POSITION**

WE NOW OFFER INSTALLATION AND SAFETY INSPECTION SERVICE BY [SupremeTech.co.uk](http://SupremeTech.co.uk)



0844 414 2324



0844 414 2425

## ALUMINIUM BUNK LADDERS LIGHTWEIGHT & STRONG



**BLA2175**



**BLA2150**

High quality anodised aluminium ladders for lightness & portability; anti-slip wide treads lightly profiled to be easy on your feet. Cap feet top and bottom to prevent ladder slipping. Being aluminium you can affix various brackets & clips to suit your own requirements. Ladders can be easily shortened. (265 tread width).

**BLAJH** Pair J locating hooks to fix on ladder

**BLAJB** Wall bracket for bunk ladder J hooks

**BLA2150** Aluminium bunk ladder 150 cm 4 rungs

**BLA2175** Aluminium bunk ladder 175.5 cm 5 rungs



## NEW BUNK SAFETY NETS

Two sizes available complete with installation accessories. Prevents luggage and children falling from overcab area or bunks.

**BSN1558** BUNK SAFETY NET 1500 x 580mm  
**BSN1858** BUNK SAFETY NET 1800 x 580mm

## GARAGE FIXING RAILS

Designed to secure items in the motorhome garage. The garage rails are a pair of anodized aluminium profiled rails to be fixed to the floor or walls. The pack of 2 rails come complete with 10 adjustable position tie point eyes. Rails are 2mtr long with end caps, fixing holes are at 305 mm centres. Sizes L 2000mm x W 35 mm x H 65mm Height includes fixbar eyes.

**FIXBAR2** GARAGE FIXING RAILS PACK OF 2  
**FIXBAYEYE** SPARE FIXING EYES PACK

## LUGGAGE NET

Luggage net ideal to stop your possessions moving about in your garage whilst traveling. Size expanded 80 x 80 cm.

**PS1012** LUGGAGE NET

## SIREN ALARM PADLOCK

**Fancy a padlock that is siren alarmed?**

The two tone alarm is set to sound for ten seconds every time it is disturbed, and resets itself automatically. This extra strong cast steel lock now provides the extra security and peace of mind that you are looking for. Countless locked sheds, garden outbuildings, garages and store rooms are broken into weekly with hardly a sound, but not any more. Disturb this little guy, and he'll make himself heard. Why tackle a lock that sounds an alarm when there are millions that don't?

Use it on bicycles, motorbikes, garden tools, furniture and ornaments, tool boxes, Motorhome bike racks, generators, vans, side gates, the list is endless. Why buy an ordinary padlock when you can buy one with a built in alarm at the same price? Can be used as a conventional non-alarmed lock as well. Works in all weather conditions, Tough HRC 50-60 shackle, batteries sealed in tamper proof steel chamber inaccessible when lock is engaged, sounds 2200 times on a set of batteries.

**PDLCKALRM** SIREN ALARM PADLOCK

## SLEEVED HIGH SECURITY CHAIN

High specification links produced from 10mm thick hardened steel square profile chain. Big internal link size of 16mm x 50mm for use with large shackles. Hard wearing synthetic canvas type fabric sleeved to prevent rubbing.

**SECCH60HD** HI SECURITY SLEEVED CHAIN 600MM  
**SECCH90HD** HI SECURITY SLEEVED CHAIN 900MM  
**SECCH120HD** HI SECURITY SLEEVED CHAIN 1200MM

## SECURITY CHAIN

Fully hardened round steel links. Increased link size (16mm x 38mm internal) for use with larger padlock shackles. PVC sheath for weather resistance.

**SECCH60** STEEL SECURITY CHAIN 600MM  
**SECCH90** STEEL SECURITY CHAIN 900MM

## HEAVY DUTY SECURITY CHAIN

Fully hardened square steel links. Increased link size (16mm x 38mm internal) for use with larger padlock shackles. PVC sheath for weather resistance.

**SECCH120** STEEL SECURITY CHAIN 1200MM  
**SECCH150** STEEL SECURITY CHAIN 1500MM

## 300KG CARGO LASH - FIXSTRAP300

Heavy duty polypropylene webbing tested to 300kg. Quick release high tension ratchet handle. Hook ends. 4.5m long x 25mm webbing. Conforms to EN12195-2

## BASIC RATCHET STRAP - PS1015

Great to have around for holding down awnings or stopping things moving about in your garage while traveling. 25mm webbing x 4.5m light duty.

## TIE DOWN CORKSCREW STAKE - PTS1705

Tie down stake is great to tie down awnings into soft ground. Screws into ground for a very solid anchor point. Also ideal to keep your dogs under control with a Medium Kennel chain (PTS1631 1.8m long.)



**FIXBAR2**



**FIXBAR2**



**SIREN ALARM PADLOCK**

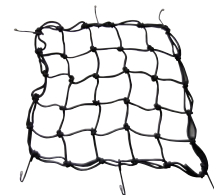

**SLEEVED HI SECURITY**



**SECURITY CHAIN**



**FIXSTRAP300**



**PS1015**



**TIE DOWN CORKSCREW STAKE**

WE NOW OFFER INSTALLATION AND SAFETY INSPECTION SERVICE BY [SupremeTech.co.uk](http://SupremeTech.co.uk)

Interior

Buy securely online at [Leisurelines.net](http://Leisurelines.net)



# WASH RACK, SEITZ S4 WINDOWS & FITTINGS



Interior

## SEITZ S4 WINDOW SYSTEM

Available in a large range of sizes, S4 is supplied as a complete kit of window and integrated Blind system, all in one box. The Seitz S4 is the window of choice by many motorhome and camper manufacturers throughout Europe. Easy installation and long life span are guaranteed: Outer and inner frame are simply screwed together from inside, clamping the window to the vehicle wall, for a lasting and continuous seal. For wall thicknesses 26 to 41mm (requires trimming of inner frame) Outer Black RAL9005 frame with Grey tinted acrylic double glazed pane. Inner frame is cream-white RAL9001. Blind material is white to the interior with a thermally reflective silver aluminised coating to the outside. Fly net is white with no pattern. High quality windows Highly recommended by CAK. S4 Top Hinged window has telescopic side arms for easy ventilation with integrated roller blind and fly net to the inside. Safety catches prevent window from being opened from outside. S4 Sliding window is installed with the fixed half pane to the rear of the aperture (based on driving direction) and the sliding pane to the front. Seitz S4 windows in all sizes are available manufactured to order. Depending on the time of year this can be 1 to 8 weeks.

- S4TH (SIZE)** Top hinged S4 windows (Sizes listed in price list)
- S4SL (SIZE)** Sliding S4 windows (Sizes listed in price list)

We keep a significant selection of the popular sizes in stock. Seitz S4 windows in the full range of all sizes are available manufactured to order. Depending on the time of year this can be 1 to 8 weeks.

- S4WCLEANKIT** Special Seitz window cleaning kit



SEITZ S4 TOP HINGED WINDOW



SEITZ S4 TOP HINGED OPENING



SEITZ S4 SLIDING WINDOW

## UNIVERSAL WINDOW WASHING RACK

Very useful washing rack that easily clamps to most window apertures. The washing rack is universal fitting; the width extends from 470mm to 900mm. Folds flat for easy storage. Metal clamps, moulded ends chromed metal rack tubes. Ideal for beach towels or wet clothing or to create shelves for shoes & clothing in wardrobes.

- WWL01** Window washing rack

## GAS STRUTS FOR FIXED BEDS AND LARGE ACCESS DOORS



- LDGS200** 200MM 90N
- LDGS244** 244MM 90N
- LDGS355** 355MM 180N
- LDGS400** 400MM 250N
- LDGS550** 550MM 200N
- LDGS600** 600MM 200N
- LDGS700** 700MM 250N



LDGS900



LDGS901



LDGS902



## GAS STRUT PIVOT MOUNTINGS

- LDGS900** 4 HOLE VERTICAL PIN BASE PLATE
- LDGS901** 2 HOLE CROSS AXLE BASE PLATE
- LDGS902** INNER THREADED PIVOT ANGLE PLATE
- LDGS903** OUTER THREADED PIVOT ANGLE PLATE
- LDGS904** THREADED PIVOT FLAT PLATE
- LDGS905** INNER BALL PIVOT ANGLE PLATE
- LDGS907** ANGLE PIVOT PLATE
- LDGS909** THREADED BALL PIVOT



LDGS903



LDGS904



LDGS905



LDGS907



LDGS909

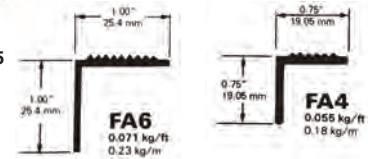

- FIXHNDL90** 90MM FOLDING TIE DOWN GALVANIZED
- B25L** LONG LEVER TENSION CLOSURE 140MM
- B25C** SHORT LEVER TENSION CLOSURE 102MM

- AETFA4** 19MM RIBBED ANTI SLIP FLOOR EDGE FINISHING ANGLE
- AETFA6** 25MM RIBBED ANTI SLIP FLOOR EDGE FINISHING ANGLE



B25L

B25C



FIXHNDL90



AETFFD674



AETFFD765



AETFFD766



AETFFD781



AETFFD789



AETINFILLBK



AETP2238

WE NOW OFFER INSTALLATION & REPAIR SERVICE BY [SupremeTech.co.uk](http://SupremeTech.co.uk)



0844 414 2324



0844 414 2425

Buy securely online at [Leisurelines.net](http://Leisurelines.net)

# STABILISING JACKS, ROOF LADDERS, EXHAUST FINISHERS, STEPS & LEVELLING BLOCKS



Exterior

The Stabilising Jacks are designed for use with Caravans, Motorhomes, Trailers and Specialist Vehicles requiring a steadying load capacity of 450 kg per jack. Fashioned in steel and protected by black powder coating or galvanised, this stabilising jacks differ from the traditional scissors design and affords notable practical advantages in operation. Just a few seconds are needed to move the jacks into the operating or the stowed traveling position.

## FITTING INSTRUCTIONS

- \* The jacks can be bolted (preferred method) or welded. Bolt the mounting flange to a suitable surface using self-locking nuts and bolts. In selecting a suitable position always take into consideration the 450-kg load capacity per jack.
- \* In some situations it may prove necessary to fabricate a bracket off the chassis/body to mount the jacks. In this case make sure it is sufficient to take the 450kg per jack loading.
- \* NB : in the stowed position, the jacks require a minimum inboard clearance of 350mm for model 45, and 450mm for model 55 (see fig 2).

## DIRECTIONS FOR USE

- \* The jacks have two detent positions, stowing horizontally for traveling and angled downwards for use.
- \* Simply pull the leg to the point of freeing the spring-loaded catch from the detent slot. Lock the leg in the jacking position detent.
- \* Lower the leg initially by holding down the locking tab and allowing inner jack tube to slide out to rest on the ground.
- \* Insert the jack rod through the front socket (fig3), ENSURING THAT THE END LOCATES IN THE SOCKET IN THE REAR WALL OF THE LEG, and apply downward hand pressure, with little effort the inner leg will extend down. Repeat the action until the vehicle or trailer is stable.
- \* To release the jacks, apply pressure to the locking tab, which can be loosened by tapping smartly with the rod if need be. The leg can now be retracted by hand without difficulty and swung upwards to lock automatically in the stowed position (fig 2)

## TECHNICAL DATA

Material:	Heavy gauge steel
Protection:	Zinc plated
Jack pad footprint:	25cm 2 per jack
Adjustment:	MDL 45 290mm to 450mm
	MDL 55 390mm to 550mm
<b>Stabilising capacity:</b>	450kg per jack static
<b>Jacking capacity:</b>	300kg per jack

The jacks are available in pairs, packaged as a kit with one jacking rod.

<b>ATSJ45G</b>	MD 45 jack kit galvanised
<b>ATSJ55G</b>	MD 55 jack kit galvanised

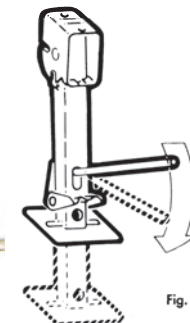
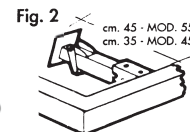
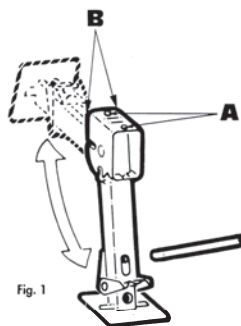
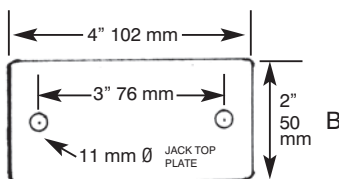

## ALUMINIUM FOLDING EXTERIOR ROOF ACCESS LADDERS

Supplied with four loose fixing brackets to fix to your choice (shown in photograph affixed for clarity). Folding stirrup on lower folding section to distance ladder away from bodywork for safe climbing. Ladder side rails extended above top rung to provide hand grip loop for safety while getting on and off the roof. Product may differ to picture. Spare mounting brackets available. **BLFSFB**

**BLF3210** Folding access ladder 9 steps & fixing brackets

**BLFLOCK** Security lock for BLF3210

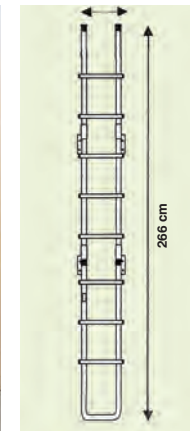

**BLF3210**

**BLF3210**

## EXHAUST END FINISHERS

Keeps your motorhome cleaner from exhaust soot deposits. While displaying a smart appearance to exhaust end. The finisher have been specially developed to direct exhaust exit down through base of finisher, while appearing to leave a normal round end to the exhaust. As no exhaust gases leave through this end it remains clean of black deposits, and so do your sidewalls. Gloss chrome finish adds to appearance, new aluminised finish will keep appearance longer than chrome plated (more corrosion-proof). L= length of finisher, ID= internal diameter, OD= outside diameter. All sizes mm.

<b>EXH103D70</b>	Finisher chromed straight exit L 360 ID 67 OD 70
<b>EXH180D60</b>	Finisher chromed straight exit L 256 ID 57 OD 60
<b>EXH183D63</b>	Finisher chromed straight exit L 255 ID 60 OD 63
<b>EXH181D60</b>	Finisher chromed downwards exit L 256 ID 57 OD 60
<b>EXH100D70</b>	Finisher chromed downward exit L 213 ID 67 OD 70
<b>EXH280D70</b>	Finisher aluminised downward exit L 213 ID 67 OD 70
<b>EXH101D70</b>	Finisher chromed downward exit L 258 ID 64 OD 70
<b>EXH281D70</b>	Finisher aluminised downward exit L 258 ID 64 OD 70
<b>EXH282D76</b>	Finisher aluminised downward exit L 206 ID 73 OD 76/70
<b>EXH283D79</b>	Finisher aluminised downward exit L 204 ID 76 OD 79/70
<b>EXH284D70</b>	Finisher aluminised downward exit L 290 ID 67 OD 70
<b>EXH285D70</b>	Finisher aluminised downward exit L 260 ID 67 OD 70

**Boxer/Ducato/Relay 1994-2002** EXH100D70, EXH280D70, EXH284D70, EXH285D70.

**Boxer/Ducato/Relay 2002-on** With rim cut off EXH101D70, EXH281D70.

**Ducato 14 2002 ON** Without rim cut off EXH282D76.

**Ducato 18 2002 ON** Without rim cut off EXH283D79.

**Daily, Sprinter/VW LT 97 on** With rim cut off EXH100D70, EXH280D70, EXH284D70 & EXH285D70.

## PLASTIC PORTABLE ENTRANCE STEP

New portable plastic entrance steps for caravans & motorhomes produced in high grade grey plastic. Produced in two versions. **ESP603G** our standard step has a safe load of 150 kg and dimensions of 410mm x 270mm x 220mm. **ESP601G** our OEM spec step is designed to meet EN1645 - 1646 for supply by manufacturers with original equipment. The step has a greater safe load of 250kg and larger dimensions of 450mm x 350mm x 250mm.

**ESP601G** ENTRANCE STEP PLASTIC GREY EN SPEC

**ESP603G** ENTRANCE STEP PLASTIC GREY STANDARD

## LEVELLING BLOCK SETS

Level blocks are designed to level up your vehicle on uneven pitches. Simply place the leveling chocks in front of the wheel you wish to raise and drive up the ramp slowly. Made of strong plastic, they are easy to clean and will not corrode. SUPPLIED 2 X BLOCKS IN A NEAT STORAGE BAG.

**LVC3230** LEVEL BLOCKS STANDARD CARAVAN

**LVC3231** LEVEL BLOCKS TRIO MOTORHOME

**LVC3232** PAIR OF ANTI SLIP PLATES FOR LEVEL BLOCKS

**LVC3233** LEVEL BLOCKS DUO MOTORHOME

**STORAGE BAG**

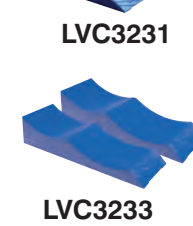
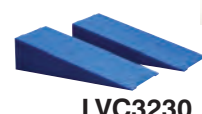

WE NOW OFFER INSTALLATION AND REPAIR SERVICE BY [SupremeTech.co.uk](http://SupremeTech.co.uk)

Buy securely online at [Leisurelines.net](http://Leisurelines.net)





# DOMETIC & CAREFREE AWNINGS

Exterior

## DOMETIC PREMIUM AWNINGS MANUAL & ELECTRIC MODELS

As the world's leading manufacturer of recreational vehicle awnings, Dometic has covered all approaches to motorhome awnings. This new motorhome awning eclipses its competitors by doing away with inconvenient support struts. This means you can use the entire space in front of your recreational vehicle. It completely eliminates the awkward, time-consuming setup of conventional awnings.

Both the Manual & Electric awnings show-stopper is the arm joint manufactured from forged steel – patent pending. This focal component of the ingenious mechatronics facilitates use of the awning without support struts. The electric variant of the Dometic Premium Awning is an innovation that is particularly convenient and safe. The electric version in particular is thus the benchmark regarding convenience and safety, fully automatic and operated at the touch of a button on the remote control. Also as standard on electric models is a wind sensor automatically retracts the awning when wind force reaches critical levels.

**All optional items for the awning range available to order.**



AWNING MANUAL			Housing white, fabric blue	Housing white, fabric silver	Housing silver, fabric blue	Housing silver, fabric silver	Housing anthracite, fabric blue	Housing anthracite, fabric silver
Width of Fabric (cm)	Extension (cm)	Weight (kg approx.)	ORDER CODE	ORDER CODE	ORDER CODE	ORDER CODE	ORDER CODE	ORDER CODE
260	250	22.9	DAM9108689939	DAM9108689943	DAM9108689941	DAM9108689944	DAM9108689942	DAM9108689945
313	250	27.0	DAM9108690073	DAM9108690076	DAM9108690074	DAM9108690077	DAM9108690075	DAM9108690078
355	250	27.2	DAM9108689548	DAM9108689652	DAM9108689866	DAM9108689875	DAM9108689867	DAM9108689876
405	250	31.1	DAM9108689868	DAM9108689654	DAM9108689869	DAM9108689877	DAM9108689870	DAM9108689878
474	250	41.8	DAM9108690087	DAM9108690090	DAM9108690088	DAM9108690091	DAM9108690089	DAM9108690092
505	250	44.2	DAM9108689653	DAM9108689879	DAM9108689871	DAM9108689880	DAM9108689872	DAM9108689881
AWNING ELECTRIC			ORDER CODE	ORDER CODE	ORDER CODE	ORDER CODE	ORDER CODE	ORDER CODE
256	250	25.0	DAE9108689953	DAE9108689956	DAE9108689954	DAE9108689957	DAE9108689955	DAE9108689958
308	250	28.0	DAE9108690079	DAE9108690083	DAE9108690080	DAE9108690085	DAE9108690082	DAE9108690086
350	250	29.3	DAE9108689547	DAE9108689550	DAE9108689964	DAE9108689966	DAE9108689965	DAE9108689967
400	250	33.1	DAE9108689968	DAE9108689552	DAE9108689969	DAE9108689971	DAE9108689970	DAE9108689972
469	250	43.8	DAE9108690093	DAE9108690096	DAE9108690094	DAE9108690097	DAE9108690095	DAE9108690098
500	250	46.2	DAE9108689551	DAE9108689983	DAE9108689980	DAE9108689982	DAE9108689981	DAE9108689984

## CAREFREE FREEDOM AWNINGS- 12 VOLT AND MANUAL AWNINGS

- Sleek Look, Light Weight
- Same Small box design no matter the awning length
- Mounts using awning rail or mounting brackets
- Support arms adjust easily with flip lock controls
- Patented floating roller technology that keeps roll tube straight and canopy tight
- Features sturdy Aluminium Case and end caps- No Plastic!
- Full or partial extension- if you don't have the space to fully extend, you can stop at any point and set up the Freedom Awning
- Manual override on 12v model in case of power loss

The Carefree Freedom Awning is available in Wall or Roof Mount Versions. It can be operated by simply holding a button (12 volt models) or by easily winding the crank. Due to the arms being stored within the lead bar they are never far from reach. There is a choice of 3 magnificent hardware colours and 2 stunning vinyl options. If you already have a Freedom Manual awning and would like the Electric Version then don't despair! Upgrading to an Electric Version is easy. All you would need is the 12v Upgrade Kit, which will fit into your existing Carefree awning hardware.



Mounting brackets, awning rooms and accessories available. Satin Silver casing options available and other awning sizes ask for availability.

AWNING MANUAL WALL MOUNT			Housing white, fabric blue slate fade	Housing white, fabric silver fade
Width of Casing (cm)	Extension (cm)	Weight (kg approx.)	ORDER CODE	ORDER CODE
257	200	20.4	CFAW257WBFM	CFAW257WSFM
300	250	23.7	CFAW300WBFM	CFAW300WSFM
350	250	26.4	CFAW350WBFM	CFAW350WSFM
400	250	28.9	CFAW400WBFM	CFAW400WSFM
450	250	34.3		
500	250	37.0		
AWNING ELECTRIC WALL MOUNT			ORDER CODE	ORDER CODE
257	200	21.7	CFAW257WBFE	CFAW257WSFE
300	250	25.0	CFAW300WBFE	CFAW300WSFE
350	250	27.7	CFAW350WBFE	CFAW350WSFE
400	250	30.2	CFAW400WBFE	CFAW400WSFE
450	250	36.5		
500	250	39.2		

AWNING MANUAL ROOF MOUNT			Housing white, fabric blue slate fade	Housing white, fabric silver fade
Width of Casing (cm)	Extension (cm)	Weight (kg approx.)	ORDER CODE	ORDER CODE
257	200	23.0		
300	250	25.4	CFAR300WBFM	CFAR300WSFM
350	250	29.7	CFAR350WBFM	CFAR350WSFM
400	250	32.2	CFAR400WBFM	CFAR400WSFM
450	250			
500	250			
AWNING ELECTRIC ROOF MOUNT			ORDER CODE	ORDER CODE
257	200	22.6		
300	250	26.3	CFAR300WBFE	CFAR300WSFE
350	250	29.3	CFAR350WBFE	CFAR350WSFE
400	250	32.2	CFAR400WBFE	CFAR400WSFE
450	250			
500	250			

WE NOW OFFER INSTALLATION AND REPAIR SERVICE BY [SupremeTech.co.uk](http://SupremeTech.co.uk)



0844 414 2324



0844 414 2425

Buy securely online at [Leisurelines.net](http://Leisurelines.net)

# FOLDING ELECTRONIC STEPS & CHASSIS ACCESSORIES



## NEW ELECTRONIC FOLDING STEPS BEHIND SKIRT FIT

Very clever disappearing motion allows the step, installed behind the side skirt, to have the fibreglass skirt fixed to the mechanism. On folding away the step brings the section of skirt to line up and hides the step installation. High quality construction for reliable operation. Galvanized and painted steel structure, Gear motor on ball bearings, Quick manual release system for emergency, Multifunction electronic control unit for total control of all step functions. Steps are supplied with motor on left as pictured.

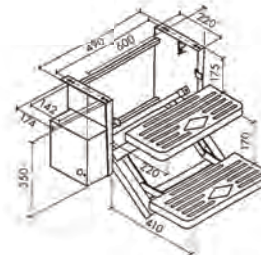

ES1057040

ES1057040

## NEW DOUBLE STEPS

Electronic double step with disappearing motion, Anti-slip, soft polyurethane footboard without sharp corners, Opening and closing by impulse, Automatic closing when starting the vehicle's engine, Gear motor protection system in case of excessive stress, Sensor for "open step" warning light. Footboard width: 400 mm. • Weight: kg. 15,000. Energy input: 3 A.

**ES1057040** DOUBLE SOFT STEP 400MM WIDE FOOT BOARD

Electronic double step with disappearing motion in 2 widths, Anti-slip anodized aluminium footboard, Opening and closing by impulse, Automatic closing when starting the vehicle's engine, Gear motor protection system in case of excessive stress, Sensor for "open step" warning light. Footboard width: 480 mm. = weight kg. 16,900, 527 mm. = weight kg. 17,400. Energy input: 3 A.

**ES1057448** DOUBLE STEP 480MM WIDE FOOT BOARD

**ES1057453** DOUBLE STEP 527MM WIDE FOOT BOARD

Electronic double step with disappearing motion, Anti-slip anodized aluminium footboard, Opening and closing by impulse, Automatic closing when starting the vehicle's engine, Gear motor protection system in case of excessive stress, Sensor for "open step" warning light. Footboard width: 440 mm. = weight kg. 15,600. Energy input: 3 A.

**ES1057744** DOUBLE STEP 440MM WIDE FOOT BOARD

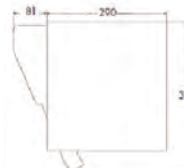

ES1057448 - ES1057453

ES1057448 - ES1057453 - ES1057744

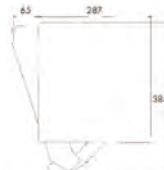

ES1057744

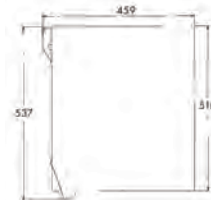

ES1057653

ES1057653

## NEW TRIPLE STEP

For the larger vehicle a well engineered Triple Electronic step completely disappearing under the vehicle, Anti-slip anodized aluminium footboard, Footboard width: 527 mm.

Weight: kg. 29,000, Energy input: 5 A

**ES1057653** TRIPLE STEP 527MM WIDE FOOT BOARD

## TOWING ELECTRICAL & ALKO COMPONENTS



**R913S** 13pin towbar socket



**R409/R** Adapter for 7 pins plug / 13 pins socket



**R410/R** Adapter 13pins plug / 7 pins socket



**R177013** Pin Socket to 7N & 7S Plugsocket



**R1750** 13 Pin Plug to 7N & 7S Coupling Socket

**R913P**

13-pin trailer or caravan plug to suit the newer European type 13-pin towbar sockets.

**R912SP**

7-Pin grey plastic trailer plug – Supplementary S-Type to suit grey towbar socket for powering trailer/caravan internal electrics.

**R912NP**

7-pin trailer plug in black plastic housing. N-type to suit black towbar socket for powering trailer/caravan road lights.

## ALKO AXLE HUB NUTS

These nuts MUST NOT be reused, always fit new nuts, and torque to 290 Nm

**ALKO1202**

AL-KO one shot axle nut, suits 2361 hub drums, 36 mm across flats.

**ALKO1079**

AL-KO one shot axle nut, suits 1637 and 2051 hub drums, 32 mm across flats.

**ALKO0977**

Safety breakaway cable for all couplings with burst ring and hook. Legal requirement.

**ACHBJ450**

800mm Jack winding handle

**ACH0300**

CARAFOOT JACK PADS SET OF 4



**R913P**



**R912SP**



**R912NP**



**ALKO1202**



**ALKO1079**



**ALKO0977**



**ACHBJ450**



**ACH0300**

WE NOW OFFER INSTALLATION SERVICE IN KENILWORTH BY [SupremeTech.co.uk](http://SupremeTech.co.uk)

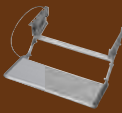

## ENTRANCE STEPS MANUAL & ELECTRIC

All our steps are made with quality galvanised steel construction for strength and long reliability. The steps are mostly produced with anodised aluminium ribbed anti slip treads with rounded edge and end caps. The Step range fully complies with the EN1646 European standards and has been subject to stringent testing. All steps have a built in safety switch to provide a step open warning when wired to a warning light (not supplied) use CBE **MCB** on page 88. All electric steps come with remote open/close wall switch with pre wired harness to enable trouble free operation and easier installation with just a few wires to connect. The steps have dual safety switches built into the steps. Steps are universal and are easily DIY adapted to fit most vehicles. They are not designed as a lift. All electric models 12 Volt DC only

## RV Wrap Around Step Rug

Adjusts to fit almost any RV step. Just wrap around your existing RV step and hook springs into the holes that fit your step. No screws, glue or tools needed. Helps to keep your RV clean by cutting down on tracked-in dirt. For manual or electric RV steps.



**ETSMATT** GREY WRAP AROUND STEP RUG

**MS1247344** Manual single step 436mm (5.8KG)

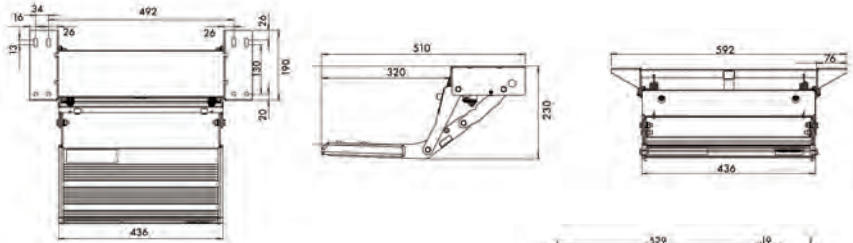

**MS1247450** Manual single step 492mm (6.0KG)

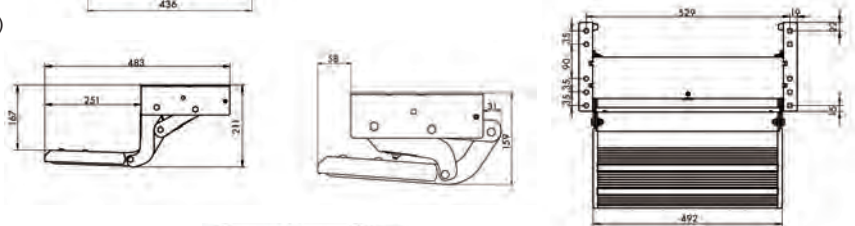

**ES1085644** Electric cassette step 440MM (13.7KG)

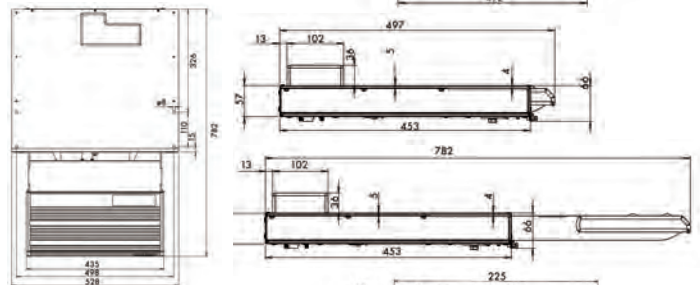

**ES1075150** Electric slim step 500MM (9.1KG)

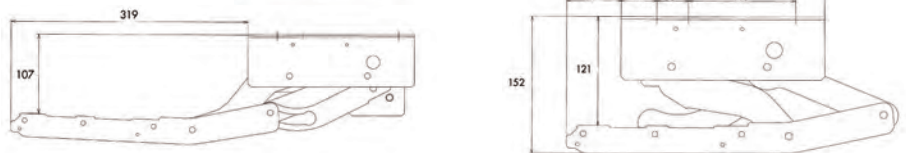
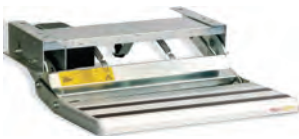

**ES1075155** Electric step 550MM (9.1KG)

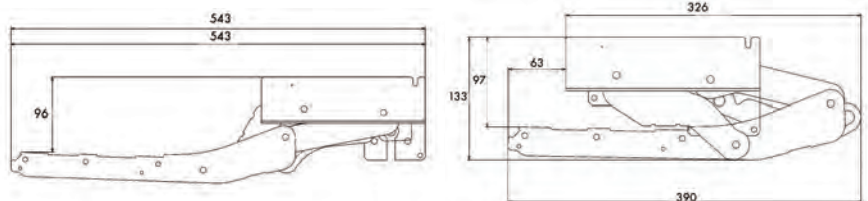
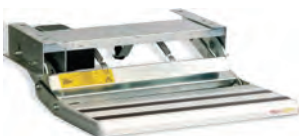

**ES1075044** Electric single step standard

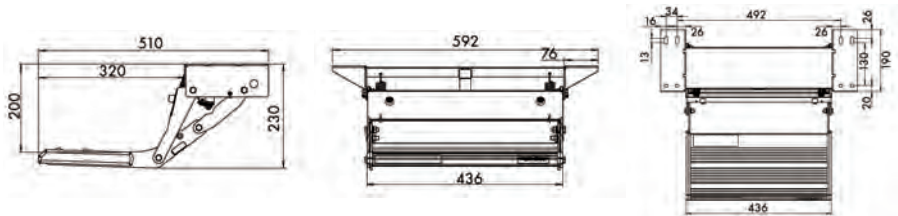

**ES1075055** Electric single step wide

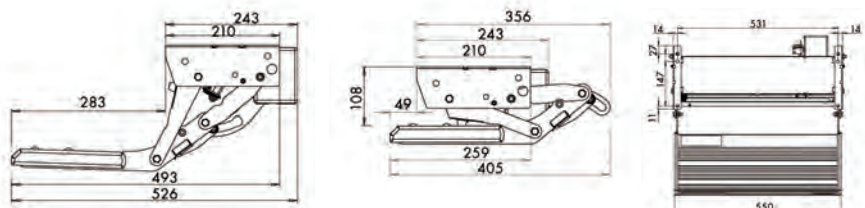

WE NOW OFFER INSTALLATION AND REPAIR SERVICE BY [SupremeTech.co.uk](http://SupremeTech.co.uk)



0844 414 2324



0844 414 2425

# FIRE EXTINGUISHERS, AUXILIARY MIRRORS AND SAFETY PRODUCTS



Safety

## FIRE BLANKET

The high performance, compact fire blanket is highly efficient in smothering fires in the earliest stages, by immediately starving the fire of oxygen. Fast and effective control of any fire is vital, so the fire blanket is manufactured to the highest specifications. Tested, approved and certified to the current British & European Standard BSEN 1869: 1997, and are kitemark certified. Top quality fire blanket packed in a flat wall-mounting container to suit most applications. They can be used in domestic, industrial and leisure environments. When combined with a Dry powder Fire Extinguisher, a total fire safety system is easily created. Container size H205mm x W175mm x D45mm

**EXTFB1** Fire Blanket W1000 x H1000mm BSEN1869

## DRYPOWDER FIRE EXTINGUISHERS

Dry powder fire extinguishers supplied complete with mounting bracket. They are Non-toxic and safe in confined spaces, Versatile and suitable for most types of fire including, Class A (combustible materials, wood, paper etc, Class B (flammable liquid fires, petrol, paint, oil etc) Class C (gaseous fires, butane, propane, natural gas etc) and electrical fires up to 1000 volts.

1KG ABC Multi purpose dry powder extinguisher with pressure gauge. Fire rating 8A/34B, minimum duration 7 seconds. Weight with mounting bracket 2.15kg. CE certifies and BSEN kitemarked.

Dimensions: 340mm x 120mm

**EXTG10** 1kg Dry Powder Fire Extinguisher Class A, B & C

600g ABC Powder Aerosol Extinguisher. Quality kitemark certified to BS615 stored pressure ABC powder extinguisher suitable for use on class A, B and C fires. Ideally suited for domestic and leisure use. Highly effective against petrol and volatile liquids, which make them ideal for vehicle protection. 3A 21B fire rating. Minimum Discharge Time 6 seconds - Range of Discharge 2 - 3 m. Operating Temperature -20 degrees to +50 degrees. Size 287mm H x 66mm OD. Weight (with bracket) 0.77kg. 5 Year Guarantee.

**EXTABC06R** Class ABC 600g Dry Powder Fire Extinguisher RED

**EXTABC06S** Class ABC 600g Dry Powder Fire Extinguisher SILVER

950g BC Powder Aerosol Extinguisher. Quality kitemark certified to BS615 stored pressure BC powder extinguisher suitable for use on class B and C fires. Ideally suited for domestic and leisure use. Highly effective against petrol and volatile liquids, which make them ideal for vehicle protection. 34B fire rating. Minimum Discharge Time 6 seconds - Range of Discharge 2 - 3 m. Operating Temperature -20 degrees to +50 degrees. Size 287mm H x 66mm OD. Weight (with bracket) 1.12kg. 5 Year Guarantee.

**EXTBC095R** Class BC 950g Dry Powder Fire Extinguisher RED

**EXTBC095S** Class BC 950g Dry Powder Fire Extinguisher SILVER

## FIRE BUCKET

Important camping safety item Plastic 'D' Shape Fire Bucket - Suitable for use with water or sand - Holds 2.5 gallons or 25lb of sand

**EXFB1** Plastic 'D' Shape Fire Bucket (7)

## MINI BLINDSPOT MIRRORS

Great view reduces blind spots, no distortions, and extra help for continental driving. Easy to install - just stick onto existing mirror.

**HEBSM11** RECTANGULAR ADJUSTABLE BLIND SPOT MIRROR

## EMERGENCY MIRROR REPAIR KIT

Very useful emergency kit provides important safety aid for continental driving. Easy to cut to shape and fix. Reliable temporary repair to prevent loss of important mirror views.

**HEMREP** MIRROR EMERGENCY REPAIR KIT

## EMERGENCY SPARE BULB KITS

Important emergency kit provides 1 spare of each bulb type & some fuses. The kit is a compulsory item of equipment to be carried on foreign travels.

**STBKCVN** EMERGENCY BULB & FUSE KIT CARAVAN

**STBKH1N** EMERGENCY BULB & FUSE KIT + H1 HALOGEN

**STBKH4N** EMERGENCY BULB & FUSE KIT + H4 HALOGEN

**STBKH7N** EMERGENCY BULB & FUSE KIT + H7 HALOGEN

## COMPACT FOLDING HAZARD WARNING TRIANGLE

The warning Triangle is a compulsory item of equipment to be carried on foreign travels. This neat folding warning triangle is ultra compact and lightweight for ease of storage.

Legal requirement in many countries.

**STCFWT** Compact folding hazard warning triangle.

## HI VIZ SAFETY WAISTCOAT

Very important safety item. Keep it in the drivers door pocket. If you are pulled over on the motorway by the local police **Don't exit the vehicle at night without wearing it.** The Police in a lot of European countries will fine you on the spot for exiting the vehicle at night without wearing a safety vest.

One vest is required to be in the vehicle for every passenger.

**STYV1** Hi Viz yellow safety waistcoat Adult

**STYV2** Hi Viz yellow safety waistcoat Child up to 12

## EMERGENCY SPARE BULB KITS

Important emergency kit provides 1 spare of each bulb type & some fuses.

The kit is a compulsory item of equipment to be carried on foreign travels.

**STBKCVN** EMERGENCY BULB & FUSE KIT CARAVAN

**STBKH1N** EMERGENCY BULB & FUSE KIT + H1 HALOGEN

**STBKH4N** EMERGENCY BULB & FUSE KIT + H4 HALOGEN

**STBKH7N** EMERGENCY BULB & FUSE KIT + H7 HALOGEN

**EXTFB1**



**EXTG10**



**EXTABC06R**



**EXTABC06S**



**EXFB1**

## HERCULES AUXILIARY MIRROR

Wide-angle view, no distortions, reduces blind spots, ideal for continental driving. Compact is easy to install above existing side mirrors. Hercules auxiliary mirror is mounted on top of your ordinary side mirrors. It provides an even greater secondary angle that can be individually adjusted from conventional side mirrors. The auxiliary mirror assures you safer travel with easier lane changing and overtaking. Great for continental driving, you can see much better as blind spots are eliminated. Parallel parking has never been easier

**HERCM**

Hercules compact blind spot mirror (2)



**PERSONAL FIRST AID KIT - STYFAK152**

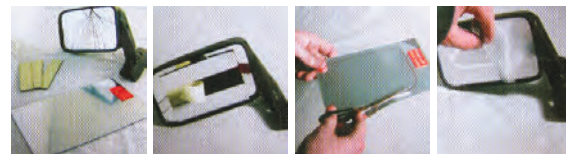
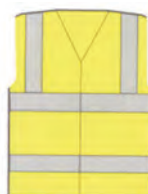

**H1**



**H4**



**H7**



WE NOW OFFER INSTALLATION SERVICE IN KENILWORTH BY [SupremeTech.co.uk](http://SupremeTech.co.uk)



Buy securely online at [Leisurelines.net](http://Leisurelines.net)

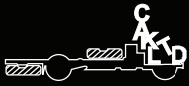

# SEAT SWIVELS RANGE



## VERY HIGH QUALITY ENGINEERED SEAT SWIVEL BASES CE APPROVED

As a safety critical item seat swivels are CE approved for peace of mind. You only find out how good your seat swivel is when you survive to tell the tale. Build quality of seat swivels is imperative, as it has to meet or exceed the strength of the vehicle manufactures design criterion for seat & seat belt mountings. Short cutting in this area is unsafe and unwise. Within the FASP, CTA and RIB ranges are swivels engineered to the highest automotive standards to meet or exceed the requirements of the Original Vehicle Manufacturer. The swivels are fabricated from heavy gauge steel & swivel around a large central pivot. The swivel plates sandwich a special self lubricating nylon wear plate thereby making the swivel virtually maintenance free.

Fixing bolts are not supplied with FASP swivels; use the equivalent or stronger bolts to the same design as the bolts installed by vehicle manufacturer. The strength rating is usually stamped into the head of the bolt (8.8, 10.2 or 12) as well as the size (M8, M10, etc.) please ensure you use suitable bolts.

CE certification standards (a) TESTED and APPROVED according to CEE 96/38 & or 2005/41/CE. (b) HOMOLOGATED according to CEE 96/37 - 96/38

Please note Fiat Ducato, Peugeot Boxer and Citroen Relay are one and the same chassis with no differences in seat swivel installation.



Universal seat Swivel+ Ducato, Talbot Express, Citroen. Pre 1994 only 430 x 350mm. FASP  
**SWVL1R** For RH seat  
**SWVL1L** For LH seat



**SWVL3R** Boxer, Ducato, Relay, RH drivers 1994 to 2006 model year.  
**SWVL3L** Boxer, Ducato, Relay, LH passenger 1994 to 2006 model year. Re-use seat belt mounting on seat 430 x 350mm (3R pictured) FASP



**SWV3CT** For LH or RH seat 1994-2006 Ducato, Boxer & Relay. CTA



X250 swivel for New Ducato, Boxer and Relay. 2006 on. FASP  
**SWVL7R** For RH seat  
**SWVL7L** For LH seat



X250 swivel for New Ducato, Boxer and Relay. 2006 on. CTA  
**SWV7CT44** For LH or RH seat H=44mm Need to trim existing seat box front cover. Or use code to get new box front below,

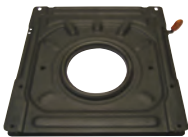

Mercedes Vito Pre 2004.  
**SWVL12R** RH Drivers  
**SWVL12L** LH Passenger  
Picture for illustration of FASP swivel

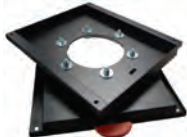

**SWV14CT** For LH & RH seat. New Master, Movano, NV400. 2011 on. 70mm FOR STANDARD HANDBRAKE



**SWV24CT-EPB** For LH & RH seat. New Master, Movano, NV400. 2011 on. 33mm FOR ELECTRONIC PARKING BRAKE



VW T4 swivel pre 96. Threaded pegs on seat box. 426 x 404mm  
**SWVL4R** VW T4 pre 96 RH  
**SWVL4L** VW T4 pre 96 LH (4R pictured) FASP

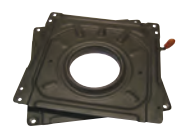

VW T4 swivel 1997 on. Bolt holes on seat box. 426 x 404mm  
**SWVL6R** For RH seat  
**SWVL6L** For LH seat FASP



Mercedes Vito / Viano 2004 on.  
**SWVL122R** RH Drivers  
**SWVL122L** LH Passenger

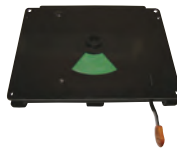

**SWVL16R** For RH seat  
**SWVL16L** For LH seat  
New VW T5 seat swivel 2004 on. 454mm x 464mm Drivers requires a handbrake lowering bracket to install. FASP



**SWV10CT** For LH or RH seat. Master, Movano, Interstar 2004 on. CTA



**SWVL17R** For RH seat  
**SWVL17L** For LH seat  
New Renault Traffic Vauxhall Vivaro Primastar seat swivel 2002 on  
Picture for illustration(not of product) FASP

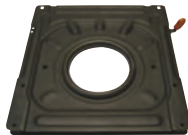

**SWVL5R** Merc Sprinter 96-> 06  
VW LT 1997 on. RH drivers.  
**SWVL5L** Merc Sprinter 96-> 06  
VW LT 1997 on. LH passenger. 440 x 425mm (5L pictured)



**SWV18CT** For LH & RH seat. Mercedes Sprinter VW Crafter 2006 on



Mercedes Sprinter VW Crafter 2006 on  
**SWV18RIBR** RH Drivers  
**SWV18RIBL** LH Passenger  
**SWV18RIBHB** Soft Handbrake cover to install swivel

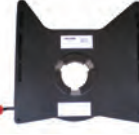

Citroen Dispatch, Peugeot Expert, Fiat Scudo 2007 ON  
**SWV20RIBR** RH Drivers  
**SWV20RIBL** LH Passenger  
Picture for illustration(not of product)



Mercedes Vito / Viano 2004 on.  
**SWV12RIBR** RH Drivers  
**SWV12RIBL** LH Passenger



**SWV13CT** Ford Transit 2000 On. Left or Right hand seat. CTA



**SWV15CT** For LH or RH seat Iveco Daily 1999/2000 onwards. CTA

### SEAT SWIVEL INSTALLATION GUIDANCE

For most installations the seat swivel will be installed onto the seat box with the seat and seat runners on top of the swivel. Firstly where fitted remove the seat belt from the anchor point on rear end of seat slide. Then remove the four or six bolts holding seat to sliders and retain. Now remove the four or six bolts holding sliders to seat box and retain. Purchase from the vehicle manufacturers main dealer four or six bolts to the same strength specification as the ones removed from the seats. Bolt the swivel onto the seat box with the original bolts used. Now bolt the seat back onto the top plate of the swivel using the new bolts purchased. Next bolt the seat back onto the seat slides using the original bolts. Finally re fit the seat belt to its anchor point if removed. For some applications it will be the case that the swivel is installed between the sliders and the seat. This will be evident by the bolt hole positions.

### STANDARD SEAT SWIVELS

Are needle bearing standard swivels (BAS codes) to suit most seat boxes provide a lower cost alternative, while maintaining high quality engineering standards. Pressure plate technology maintains strength. (Not certified)



**BAS1C** Standard swivel + pre 94 Ducato. 425 x 355mm



**BAS1C02** Standard swivel 02-06 Ducato. 425 x 355mm

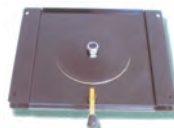

**BAS5C** Standard swivel Merc Sprinter 96->06 / VW LT. 470 x 425mm

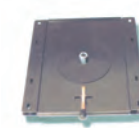

**BAS6C** Standard swivel Master, Movano, Interstar 470 x 425mm



**BASTR00** Standard swivel Ford Transit 2001- 2006 and 2006 on. 480 x 470mm

WE NOW OFFER INSTALLATION AND SAFETY INSPECTION SERVICE BY [SupremeTech.co.uk](http://SupremeTech.co.uk)



0844 414 2324



0844 414 2425

Seat Swivels

Buy securely online at [Leisurelines.net](http://Leisurelines.net)



### STAINLESS 316 (A4) DECK FILLERS

All have cap chains to prevent loss, except waste versions where cap chain would prevent pump out suction. Can be used in marine and other applications.

316 A4 STAINLESS C/W COLOUR CODED NYLON KEYLESS CAP (pic A)

DFS38PKD DIESEL (RED CAP) 38 mm (WAS 09338)

316 A4 STAINLESS C/W STAINLESS KEYLESS CAP (pic B)

DFS38SKD DIESEL 38 mm (WAS 09838)

DFS38SKP WASTE PUMP OUT 38 mm (WAS 09938)

316 A4 STAINLESS KEYED CAP (pic C)

DFS38BKD DIESEL 38 mm (WAS 08860)

DFS38BKP WASTE PUMP OUT 38 mm (WAS 08860)

### BLACK NYLON SCREENED VENT

Use for neat through wall venting of tanks. Ideal for fillers without a vent connection. Can be used to vent toilet holding tanks. Suitable for 15-19mm hose.

DFV74200 BLACK NYLON SCREENED VENT. (pic E)

### MARINE SKIN FITTINGS

A vital component in the bilge pump system where strength and quality should not be compromised. Made from lightweight, non corrosive Acetal they are strong and very high quality. Available in 4 sizes: 16mm (5/8"), 19mm (3/4"), 25mm (1") & 38mm (1 1/2")

WSF5018 16mm (5/8") SKIN FITTING

WSF5131 19mm (3/4") SKIN FITTING

WSF5204 25mm (1") SKIN FITTING

WSF5425 38mm (1 1/2") SKIN FITTING

### MARINEFLEX HOSE

Flexible marine sanitation hose we have developed to ensure it is odour permeation proof. Essential for marine toilets and waste water to prevent nasty smells. Smooth bore to prevent clogging available in sizes 38mm, 25mm & 19mm.

M5S 38 MM MARINEFLEX Marine Toilet & Waste Hose

M2S 25 MM MARINEFLEX Marine Toilet & Waste Hose

M3S 19 MM MARINEFLEX Marine Toilet & Waste Hose

### SHOWER CATCHMENT TANKS

Installed in Boats for automatic collection and pumping of wastewater from showers or outlets below the water line or inlet of holding tank. Also used for the automatic transfer of waste over long pipe runs to holding tank.

We build up the tank to suit your installation, any number of inlets are welded into the plastic tank, we install our automatic level switch and set up the tank to take your choice of bilge pump, this can be a submersible bilge pump or an external inline bilge pump. Almost any combination is possible. The most popular of our tanks used for a catchment tank is the 250T tank. This is usually fitted with bilge pump MBP570115 and automatic float MAS850105.

### Pressure Pump Strainer

WFV2060 - Pressure Pump Strainer

For Direct Connection To 13 mm (1/2") Plumbing Systems

- Easily maintained without disconnecting from pipework
- Clear bulb for easy inspection
- Ideal for use with freshwater pumps
- Prevents debris from entering the pump



WFV2060

### ORCA BILGE PUMP RANGE

Orca Electric Bilge Pumps Compact and Powerful

- Simple to install multiple wire locations
- High performance - low amp draw means long battery life
- Easy maintenance access to motor cartridge and filter area
- Available in 500, 950 and 1300 GPH models
- 3 year Warranty

WBE0500 (500 US GPH 12 V d.c.)

WBE0950 (950 US GPH 12 V d.c.)

WBE1450 (1300 US GPH 12 V d.c.)

WBE1454 (1300 US GPH 24 V d.c.)



ORCA BILGE PUMPS

### Float Switch WBE9002

Float switch Ideal for use with Electric Bilge Pumps

Including Whale Supersub or Orca Ranges

- Environmentally friendly - no toxic mercury
- Easy to install mounted on either horizontal or vertical surface (e.g. bulkhead or hull)
- Suitable for installations where amp draw is up to 15 amps
- Compact design
- Can be used as a high water bilge alarm (when vertically mounted)



WBE9002

### SUPERSUB SMART 650 WSS5212

Low profile fully automatic bilge pump. Narrow design ideal for tight spaces, automatically senses bilge water level and switches on and off. 12volt 3.4 A, Size L 212 x W 54 H 75 height includes outlet in vertical position, swivel 3/4" 19mm outlet, Flow rate at 1mtr (3ft) head 2040 litres per hour (550 US GPH)

- Quick and easy installation
- Unaffected by wave motion
- Environmentally friendly - mercury free
- Includes manual override facility
- Solid state Electric Field Sensor Technology switching - no moving parts.



WSS5212

### STAINLESS 316 (A4) DECK FILLERS



KEYLES

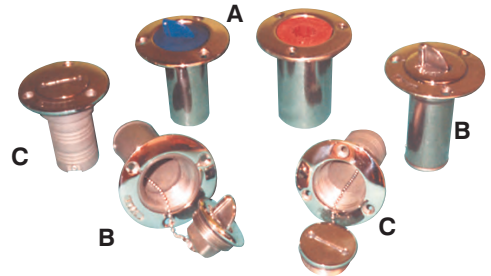

D

DFK09901



E

DFV74200



SKIN FITTING  
WSF5018



MARINEFLEX HOSE

### Strum Box

3/4" (19mm) Strum Box with Multi-Directional Port and Non-Return Valve

- Ideal for use with remote mounting bilge pumps (see page 45)
- Easy installation - multi directional port options for either top or side entry
- Non-return valve prevents back flow into the bilge
- Designed to fit deep down in the bilge



WSB3422

### JABSCO ECO-Switch

The Rule ECO-Switch is an ecologically sound automatic bilge pump control switch. Featuring a non-mercury design, the pump operates with simple air pressure. As water rises in the bilge, air rises in the air tube that is attached to the switch. The air pressure activates the switch which controls your pump. All wiring is out of the water and there are no submerged electrical connections at all. Offering complete reliability and outstanding performance, the Rule ECO-



JMBS39



## JABSCO LITE FLUSH TOILETS

A NEW Electric Toilet designed to give your bathroom a modern, stylish look. The Lite Flush is JabSCO's new stylish low power consuming electric toilet. The installation is quick and straight forward with Integral rinse and waste pump system with low water usage of only 1.2 litres. The compact and lightweight design with its ceramic bowl, slow close seat and lid and plastic outer casing makes it very easy to clean. It is fitted with a new quiet and efficient flush pump which has large clearances to help prevent blockages.

Supplied with a new multi-function "one touch" wall mounted control panel.

**Fitting:** Connections for 1/2" (19mm) ID inlet hose and 1 1/2" (38mm) outlet hose.

**Size:** 14 1/2" (37cm) high x 15 1/2" (40cm) wide x 15 1/2" (40cm) deep.

**Weight:** 24lb (11kg).

**JM58500-1012** LITE FLUSH 12V TOILET & CONTROL PANEL



**JM58500-1012**



**JM58040**

## JABSCO DELUXE FLUSH TOILETS 17" STRAIGHT BACK

The Deluxe Flush range is JabSCO's newest offering to the top of the range electric toilet market. The stylish and extremely compact design is carefully contoured to conceal the flush pump, wiring and plumbing, whilst still featuring a full-size household seat. The toilets feature a NEW multifunctional 'one touch' control pad, Choice of four rinse options for minimum water usage 1.5 US Quarts (1.5 litres), Anti-blocking centrifugal flush pump, High vitreous china bowl, No 'dirt traps' for maximum hygiene and easy cleaning. Series are supplied with a solenoid valve and syphon breaker assembly for connection to any existing pressurised water system capable of delivering 2.9 US gpm (11 lpm) or more. The siphon breaker ensures there is no backflow from the toilet into the water system. **Fitting:** Connections for 3/4" (19mm ID inlet hose and 1 1/2" (38mm) outlet hose. **Size:** 17 1/4" high x 14 1/2" wide x 17 1/2" deep (44.0cm x 37.0cm x 44.5cm).

**Weight:** 58040 Series - 69lb (31kg).

**JM58040-1012** 12V DELUXE FLUSH 17" STRAIGHT BACK ELECTRIC TOILET WITH SOLENOID

**JM58040-1024** 24V DELUXE FLUSH 17" STRAIGHT BACK ELECTRIC TOILET WITH SOLENOID



**JM29015**



**JM29295**

## JABSCO WASTE PUMP

Robust diaphragm pump passes solids, effective in emptying holding tanks. Multi-positional pump head offers a variety of installation options. 5 gpm (19 lpm) output, Self-priming up to 10ft (3m). Capable of extensive dry running, Compact and simple design. **Fitting:** Connections for 1 1/2" (38mm) ID hose. **Size:** 10.9" long x 6.1" wide x 4.4" high (27.7cm x 15.5cm x 11.1cm). **Weight:** 6lb (2.7kg).

**JM50890-1000** WASTE PUMP 12V 5GPM 19LPM

## JABSCO Run-Dry Macerator Waste Pump

Now with a fully sealed motor and a new more four bladed chopper added to further reduce the possibility of clogging. Detects the absence of fluid then shuts-off pump before impeller is damaged. Sensor provides adequate run-dry period to allow initial priming of the pump. Self-priming to 4ft (1.2m) vertical lift. **Fitting:** Inlet Port: 1 1/2" (38mm) Hose Barb plus 1 1/2" NPT. Inlet Port, **Size:** 11 3/8" long x 4 3/4" wide x 3 5/8" high (29cm x 12cm x 9cm).

**JM18590-2092** MACERATOR PUMP 12V 12GPM 45LPM



**JM30573**

## JABSCO Y-Valve

Robust Y-Valve with rotating ports allow for variable routing of hoses onto the valve. Waste and corrosion resistant construction. Padlock can be added so that waste can only go to the holding tank to comply with some local regulations throughout. **Fitting:** Connections for both 1 1/2" (38mm) ports and 1" (25mm) inlet port. **Size:** 7 5/8" long x 7 1/4" wide x 4 5/8" high (20cm x 19cm x 12cm).

**JM45490-1000** Y INLINE DIVERTER VALVE 38mm & 25mm



**50890**



**JM18590**

## JABSCO Shower Drain Pump

Robust diaphragm pump suitable for shower and sink drain applications with a multi-positional pump head, 4.2 gpm (16 lpm) open flow output at 3ft (1m) head, Self-priming up to 10ft (3m) vertical lift allows mounting above wet bilges, Flexible Installation, Compact and simple design, Filter-less, Quiet running, Capable of extensive dry running, Corrosion resistant parts. **Fitting:** Connections for 3/4" (19mm) ID Hose. **Size:** 11.7" long x 5.9" wide x 4.4"

**JM50880-1000** SHOWER DRAIN PUMP 12V 16LPM



**JM45490**



**JM50880**

## RULE Electric Submersible Pumps

This is just a selection of the most popular products from the range. All models are available to order if we don't have it in stock.

3/4" (19mm) discharge outlet.

**JMBP24** 12V 360GPH 1363LPH SUB BILGE PUMP

**JMBP25D** 12V 500GPH 1893LPH SUB BILGE PUMP

**JMBP20R** 12V 800GPH 3028LPH SUB BILGE PUMP

**JMBP21R** 24V 800GPH 3028LPH SUB BILGE PUMP

1" (25mm) discharge outlet.

**JMBP27D** 12V 1100GPH 4162LPH SUB BILGE PUMP

**JMBP28D** 24V 1100GPH 4162LPH SUB BILGE PUMP

## Rule-A-Matic® Float Switch

Latest design now has removable base for easy cleaning & servicing, a mercury free snap switch tested to over one million cycles and marine grade "blocked" wire. Designed for pumps drawing up to 14 Amps at 12 volt DC. **Size:** 2 1/4" x 5" x 1 3/4" (57 x 127 x 58mm).

**JMBS35A** RULE A MATIC FLOAT SWITCH 12V 14A 24V 7A

**JM59510-0012** MAGNETIC DRIVE HOT WATER CIRCULATION PUMP 12V 19MM CONNECTIONS



**JMBP24R**



**JMBP25D**



**JMBP20R**



**JM59510**



**JMBP27D**



**JMBS35A**

## VENTED LOOPS

**JM29015-000** 3/4" 19MM VENTED LOOP

**JM29015-0010** 1 1/2" 38MM VENTED LOOP

**JM29015-0020** 1" 25MM VENTED LOOP

## In-Line Non-Return Valves

Non-return valves fit in a pump's suction hose to aid priming and prevent backflow of water into the bilges.

**JM29295-1000** INLINE NON RETURN VALVE 25MM 1"

**JM29295-1010** INLINE NON RETURN VALVE 40MM 1 1/2"

**JM29295-1011** INLINE NON RETURN VALVE 19MM 3/4"

## Pressurized Accumulator Tank

Improves all pressure controlled water systems. **Fitting:** Connections for 1/2" (13mm) ID hose, optional ports available. **Size:** 21oz (0.6 liter) - 4 3/8" deep x 4 3/4" wide x 7" high (11cm x 12cm x 18cm).

**JM30573-0003** JABSCO ACCUMULATOR 0.6LTR





# MANUAL PUMPS, WASTE & BILGE ACCESSORIES



## DIVERTOR VALVES

Allows one pump to draw from two locations enabling flexibility of pump installations. Smooth lever operation, Precision machined eliminating seepage and odour problems. Teflon lubricated non-stick operation. Complies with USCG rules for Type 3 waste systems. Handle extension WEK5634 (optional) enables fitting behind bulkhead or panel. 2 models for 1" (25 mm) and 1 1/2" (38 mm) hose.

**WDV5606 1 1/2" (38 mm) DIVERTOR VALVE.**

**WDV5630 1" (25 mm) DIVERTOR VALVE.**

## SUBMERSIBLE BILGE PUMPS

**SUPERSUB 360 / 500** is a low profile design for narrow bilges. It can be installed with horizontal or vertical outlet position. The strainer is removable for easy cleaning & is designed to leave a minimum water level of 10mm (3/8") in bilge. The pump is also easy to clean with "twist lock" assembly/disassembly. There is a choice of flow rate of 25 or 35 litres per min (360 or 500 gals per hour). The pump can be mounted on horizontal or vertical surfaces. Outlet connection 19mm, If a 19mm non return valve is fitted inline (Use WL1219) it stops water flowing back into bilge. Very low power consumption (360 1.9A average, 500 2.5A average). 12 V DC Only.

**WSS3612 SUPERSUB 360 BILGE PUMP**

**WSS5012 SUPERSUB 500 BILGE PUMP**

**GULPER 320 REMOTE MOUNTED BILGE PUMP**

**GULPER 320** Remote mounting Bilge Pump Specially designed to pump waste water at outputs up to 20 Litres per minute. The pump has non-choke valves is self-priming. Will run dry and pump a mixture of air and water. No filter is required. Easy to install in confined spaces because of multi directional head so can be mounted almost anywhere. Quiet running with Low power consumption makes the GULPER 320 the ideal choice remote bilge pump. Performance meets ISO15083 Small Craft Bilge Pump standard for vessels up to 12m (39.4 ft).

**WBP2052B GULPER 320 BILGE PUMP 12 VOLT**

**WBP2054B GULPER 320 BILGE PUMP 24 VOLT**

## SHOWER DRAIN & WASTE WATER PUMP

**GULPER 220** Shower Drain & Waste Water Pump Specially designed to pump waste water at outputs up to 14 litres (3.7 US gals) per minute. Quiet running with low power consumption. Large single diaphragm, with virtually non-choke valves & double outlet valve ensuring a continuous flow. No filter required, Will run dry without damage and pump a mixture of air and water, Self-priming up to 3 metres (10 ft). Easy to install in confined spaces with Multi directional head so Can be mounted almost anywhere.

**WBP1552 GULPER 220 shower & waste water pump 12 VOLT**

**WBP1554 GULPER 220 shower & waste water pump 24 VOLT**

## ELECTRIC TOILET WASTE PUMP

**GULPER TOILET PUMP** For Holding Tanks & Vacuum Systems pumps Up to 18 litres (4.75 US gal) per minute. Easy to maintain large Virtually unblockable, single diaphragm has a rotatable inlet and outlet allowing flexibility, while being installed in awkward locations so it can be mounted in the most convenient part of boat. Can run dry without damage & is self-priming up to 3m (9.8 ft). Pumps unmacerated waste & a mixture of air and waste. Ideal for self pump out on Narrow boats.

**WBP2552 GULPER TOILET WASTE PUMP 12 VOLT**

**WBP2554 GULPER TOILET WASTE PUMP 24 VOLT**

## MANUAL TOILET WASTE PUMP

**SANITATION PUMP** Can be mounted in various orientations/positions. High quality lightweight yet tough ABS plastic housing keeps in nasty smells. Easy to clean (no tools required) with large unblockable valves. Output up to 56 litres (14.8 US gals) per minute. Maximum lift is 4.5 m (15ft) & Maximum head is 4.5 m (15ft). Pump has 38mm (1 1/2") inlet and outlet. Ideal for industrial applications and mobile toilet units as a backup.

**WBP0527 SANITATION PUMP BULKHEAD MOUNT**

## BILGE STRAINERS

**BILGE STRAINERS** are fitted at end of suction hose deep in bilges (allowing maximum amount of water to be pumped from bilges while stopping debris entering suction hose).

Fitted non-return valve prevents drain back while removable straining plate enables easy cleaning. Available in top entry (for deeper bilges) or side entry (shallower bilges).

Suitable for 1" (25mm) and 1 1/2" (38mm) hose.

**WSB4222 STRAINER SIDE ENTRY**

**WSB5865 STRAINER TOP ENTRY**

## HAND & FOOT OPERATED MANUAL PUMPS

**WGP0418 FLIPPER PUMP MK 4 Hand pump**

Light easy to & fro movement pumps 7 litres per minute. Swiveling outlet makes it suitable for use with two sinks. Good flow control, suitable for fresh & salt water.

**WGP0650 'V' PUMP MK 6 Hand pump**

Smooth flow discharges on each up and down stroke, pumps approx. 8 litres per minute. Narrow footprint and swiveling action allows installation between two sinks. Height adjustable when in use. Suitable for fresh & salt water.

**WGP0550 GUSHER GALLEY MK 3 Foot pump**

Smooth, double acting, pumps on up and down stroke to supply 16 litres per minute. Many mounting variations are possible with multi directional water connections. Suitable for fresh & salt water usage.

**WGP1309 TIPTOE PUMP MK 4 Foot pump**

Neat thru-floor mounted plunger, locks down flush with floor when not in use. Easy smooth action for output of 7 litres per minute. Suitable for fresh & salt water usage.

**WGP4618 BABY FOOT PUMP MK 2**

Compact, low-cost single acting, useful in restricted spaces. Smooth performance provides 8 litres per minute. Comfortable pumping action, easy to install



1 YEAR WARRANTY

WSS3612



WDV5630



WBP2052B

3 YEAR WARRANTY



WBP1552

1 YEAR WARRANTY



WBP2552

1 YEAR WARRANTY

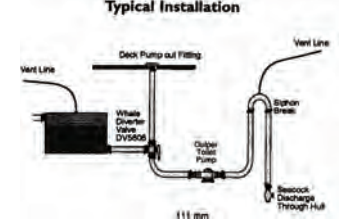

Typical Installation



SB4222 Side Entry



SB5865 Top Entry



WBP0527

5 YEAR WARRANTY

## Gusher Galley Mk 3



5 YEAR WARRANTY



Flipper Pump Mk 4

5 YEAR WARRANTY

## Tiptoe Pump Mk 4



5 YEAR WARRANTY



V Pump Mk 6

5 YEAR WARRANTY

## Babyfoot Pump Mk 2



5 YEAR WARRANTY

WE NOW OFFER INSTALLATION SERVICE IN KENILWORTH BY [SupremeTech.co.uk](http://SupremeTech.co.uk)

Marine

Buy securely online at [Leisurelines.net](http://Leisurelines.net)



## NEW NAUTIC PRODUCTS FLEXIBLE WATER, WASTE & FUEL TANKS

The technique of storing and transporting liquids through the use of flexible tanks has many advantages: - lightweight but immensely strong - handy shape and size - extremely adaptable due to inherent flexibility easy installation.

**NAUTIC FLEXIBLE TANKS** provide many advantages over rigid tanks and have therefore, become very popular with both yacht-builders and boat owners.

Each of these tanks uses an extremely rugged 935-dtex nylon fabric, coated on both sides with a neoprene / nitrile compound.

Heavily lapped seams are inside-reinforced with a "doubler" to provide extra strength. All **NAUTIC** tanks are vulcanised to assure leak proof panels and seams for years of trouble-free service.

Because of their flexibility and the range of sizes, these tanks can fit into almost any space, especially those odd-shaped places that would otherwise be wasted.

**NAUTIC PRODUCTS** tanks are very easy to work with allowing custom placement of fittings to suit your particular requirements and making it simple to install them (See Fittings for Nautic Products Flexible Tanks)

### Fresh Water Tank

Our most popular application is also the easiest way to increase or replace water capacity on boats whose tank is inadequate or deteriorated.

**NAUTIC** flexible water tanks use an exclusive Tedlar inside lining to maintain a taste-free system compared to most fiberglass and metal tanks that contribute a distinct, unpleasant taste to fresh water, Tedlar does not. No venting is required for water tanks; only a fill pipe and a simple draw line to head and / or gallery pumps.

### Waste holding tank

The more rigorously enforced laws against overboard discharge now make non-compliance extremely costly. A **NAUTIC** flexible holding tank, on the other hand, provides a relatively inexpensive Type III solution. In addition, the Tedlar lining of these **NAUTIC** tanks prevents gas permeation, thus stopping a major odour problem with many other holding tanks. Combined with a few other components, this solution is both legal and far less costly than replumbing a vessel or installing a more complex and expensive Type I or Type II system: it occupies less space and requires no electrical power. *(The illustrated example would allow those travelling into unrestricted waters to pump overboard.)*

You cannot use an unvented flexible tank for waste holding, it MUST be a vented tank, and the vent line must exit to the outside the boat.

### Portable fuel tanks

**NAUTIC** Products Flexible Portable Fuel Tanks are a remarkable improvement over the conventional metal fuel tanks. Their rubber construction cannot leave rust or rings on wood, fiberglass or metal decks; the soft structure will not scrape off paint. They bring the convenience of fitting into small spaces and being able to be rolled up when empty. **NAUTIC** tanks are both easier to carry and easier to tie down afloat, don't rattle underway and show by their size how much fuel remains. They are also heat resistant.

#### NAUTIC - Fuel Tanks & used water holding tanks (Large Capacity)

CODE	Capacity (L/Gal)	Dimensions cm
NFT5621	300 / 80	139 x 127
NFT5622	470 / 125	139 x 151
NFT5623	600 / 160	139 x 173
NFT5624	750 / 200	139 x 204
NFT5625	1000 / 265	139 x 256
NFT5626	1150 / 300	139 x 278
NFT5627	1325 / 350	139 x 320
NFT5628	1500 / 400	139 x 362
NFT5630	1600 / 422	139 x 382
NFT5629	2000 / 530	139 x 466

### ADDITIONAL FITTINGS

We have designed a comprehensive range of nylon fittings to be used only on **NAUTIC** tanks. Each type of fitting is composed of 3 parts which ensure together with the rubber seal and the rubber coated fabric a complete seal.. Generally, vent fittings are required on holding or gas tanks (not required on water), should be positioned at the higher end of the tank, while draw fittings are best located at the lower end. Under no condition should fittings be installed on the bottom side of the tank. All fittings should be installed in the top half of the tank and not closer than 4" to the edge and not through a seam doubler.

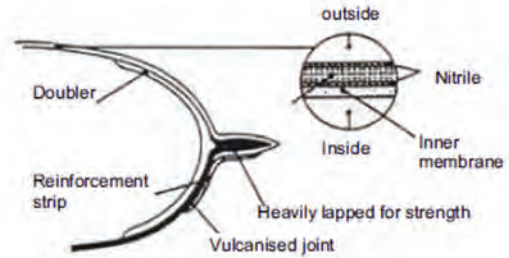

CONSTRUCTION



#### NAUTIC - Tanks for fresh water and drinking water

CODE	Capacity (L/Gal)	Dimensions cm
NFT1120	55 / 14 ½	67 x 62
NFT1150	90 / 23 ½	67 x 85
NFT1160	135 / 35 ½	67 x 115
NFT1170	260 / 68 ½	85 x 139
NFT1180	200 / 52 ½	67 x 158
NFT1210	150 / 39 ½	110 x 152 x 152

#### NAUTIC - Fuel Tanks & used water holding tanks

CODE	Capacity (L/Gal)	Dimensions cm
NFT5120	55 / 14 ½	69 x 64
NFT5150	95 / 25	69 x 87
NFT5160	140 / 37	69 x 117
NFT5180	200 / 52	69 x 160

#### NAUTIC - Portable Fuel Tanks for Outboard Motors

CODE	Capacity (L/Gal)	Dimensions cm
NFT51100	25 / 6	42 x 23 x 25
NFT51101	35 / 9	42 x 32 x 25
NFT51102	50 / 13	42 x 45 x 25
NFT51103	70 / 18	42 x 61 x 25
NFT51151T	35 / 9	73 x 45 x 35 x 17
NFT51153T	70 / 18	73 x 45 x 35 x 30





# NAUTIC BOILERS



## CALORIFIER & MAINS ELECTRIC STORAGE WATER HEATERS.

Our range of Nautic water storage heaters have been developed to ensure high quality and reliable water heaters are available in a wider range. Many features, normally supplied as extras or options, are included as standard with the Nautic boiler range.

### NAUTIC BOILER RANGE

Manufactured in six models the 19 litre model is rectangular, the 12, 22, 30, 45 & 60 litre models are horizontal cylinders. The Nautic boilers are highly energy efficient, using the waste heat from your engine cooling system to provide hot water to your pumped domestic water system. To ensure water is available in all situations, the Nautic boilers come as standard with 1200 watt electric immersion elements with adjustable thermostat. The highly efficient design and construction of the nautic boilers provide quick heat up rates, large surface area copper heat exchanger enables effective heat transfer to the stored water. A brass access flange permits easy interior inspection of Nautic models.

Please note BB1912 cannot be mounted on its side as picture it is purely this way for photography. Connections must be at the top or base.

All Nautic Boiler models provide high levels of performance and efficiency and are equipped with the following additional standard features,

- ⌘ Glass lined steel tank for strength & very long life.
- ⌘ Strong stainless steel mounting saddle and brackets.
- ⌘ Pressure release safety valve (4 bar + - 1).
- ⌘ Magnesium anode protects boiler from galvanic currents.
- ⌘ Boilers tested to 8 (bar) 200 % of operating pressure to ensure safety and product quality.
- ⌘ High quality outer casing to protect thermally efficient polyurethane insulation jacket.
- ⌘ Boiler element voltage 230-240 volt 50 hz.

Due to the closed cell polyurethane foam insulation and outer casing the water temperature losses will be less than 1°C per hour. This enables water to be stored and remain warm for a longer period.

- 1, Cold water in 1/2" BSP male
- 2, Domestic hot water out 1/2" BSP male
- 3, Engine cooling water in 1/2" BSP male
- 4, Engine cooling water out 1/2" BSP male

PRODUCT SPECIFICATIONS	NAUTIC BOILERS					
BOILER MODEL	BB1212	BB1912	BB2212	BB3012	BB4512	BB6012
HEAT EXCHANGER	YES	YES	YES	YES	YES	YES
MAINS ELEMENT WATTS	1200W	1200W	1200W	1200W	1200W	1200W
VOLTAGE	230V	230V	230V	230V	230V	230V
WATER CAPACITY LTR	12	19	22	30	45	60
WEIGHT KG	12	13	14	16	20	24
MAX LENGTH L1 (mm)	395	495	475	620	880	1060
CASING LENGTH L2 (mm)	250	420	400	545	805	985
FIXING CENTRES L3 (mm)	175	360	300	445	710	885

### NAUTIC BOILER SIZES

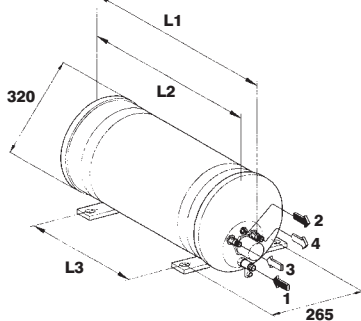

BB22/30/45/60

### NAUTIC BOILER SIZES

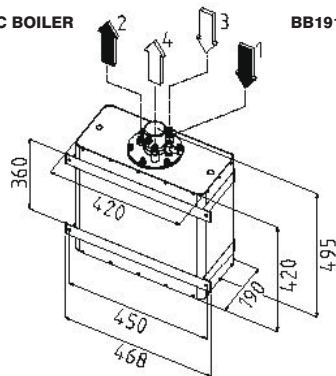

BB1912

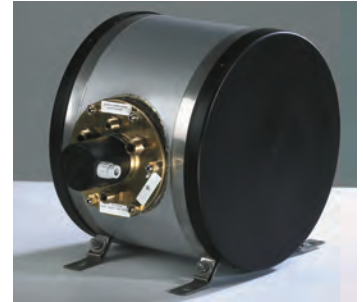

NAUTIC BB12

### STAINLESS TANK NAUTIC BOILERS (Mains element + Calorifier)

The Nautic Stainless has all the features of our standard single coil Nautic range with the added advantage of ANSI 316L stainless steel tank for long-term reliability in highly corrosive installations. Polyurethane injected foam insulated with outer casing as standard. Specially designed for saltwater or other corrosive environments. Sizes the same as standard nautic boilers. Stainless models all connections 1/2" BSP male thread.

**BB2212X 22 LITRE + MAINS 1200 WATT ELEMENT + CALORIFIER**



BB2212X

### THERMOSTATIC MIXER VALVE FOR NAUTIC BOILERS

Our new Thermostatic mixer valve kit is manufactured in plated brass. Suitable for installation directly to the boiler with hose and connectors. The Mixer valve automatically adds cold water to the hot water being drawn from your water heater to prevent scalding water arriving at your tap. Those at greatest risk of scald injury include children, disabled and diabetics.

**BBTMIXV THERMOSTATIC MIXER VALVE FOR NAUTIC BOILERS 3/8" BSP**  
**BBTMIXV12 THERMOSTATIC MIXER VALVE FOR NAUTIC BOILERS 1/2" BSP**

### NAUTIC CALORIFIER XT® (Mains element + Single /Twin coil)

A new development of our range, the Nautic Calorifier XT® is produced with single or twin coils & XT® technology. Electric element is installed with the hot and cold water connections, thermostatic anti scald mixer valve and 4 bar pressure release safety valve. The twin coil version allows engine cooling system and a direct feed by a Webasto or Eberspacher supplementary heater to be used individually or together in independent circuits. The boiler is made from 100% copper for exceptional performance and reliability benefits. Polyurethane insulation jacket enables the boiler to retain heat for up to 24 hours. Supplied with stainless steel mounting brackets and domestic water connections ready for 15mm push fit and barbed engine coil connections. A 230-240 volt electric element is installed with the hot and cold water connections, a thermostatic anti scald mixer valve and 4 bar pressure release safety valve. Operating pressure 16- 45 psi (1-3 bar), built in 4 BAR pressure relief safety valve. Adjustable thermostat set to 80°C max. Adjustable thermostatic mixer valve for water temperature outputs of 45°C to 65°C.

The twin coil version allows for the engine cooling system and a direct feed by a Webasto or Eberspacher supplementary heater to be used individually or together in independent circuits.

We have other boiler sizes in development so please ask if you want something different.

- BC4012C 40 LITRE + MAINS 1250 WATT ELEMENT + SINGLE CALORIFIER**  
Length 760mm, Height 350mm, Width 340mm. Dry weight 12.5 kg.
- BC5512TC 55 LITRE + MAINS 1250 WATT ELEMENT + TWIN CALORIFIER**  
Length 975mm, Height 350mm, Width 340mm. Dry weight 14 kg.
- BC6512C 65 LITRE + MAINS 1250 WATT ELEMENT + SINGLE CALORIFIER**  
Length 855mm, Height 410mm, Width 400mm. Dry weight 16 kg.
- BC7512TC 75 LITRE + MAINS 1250 WATT ELEMENT + TWIN CALORIFIER**



BC5512TC

WE NOW OFFER INSTALLATION SERVICE IN KENILWORTH BY [SupremeTech.co.uk](http://SupremeTech.co.uk)

Marine

Buy securely online at [Leisurelines.net](http://Leisurelines.net)

# NAUTIC PRODUCTS



We have manufactured and supplied a wide range of quality equipment for over 45 years. We endeavour to specify products to the highest quality to ensure long term reliability and performance in use. We have collected into this section a selection of our product range suitable for marine use. Many of the items in other sections are specified to marine grade standards to meet our commitment to the utmost reliability in our products.

In our kitchen section you will find the comprehensive SMEV sink and hob range these products are specified with flame failure devices as standard making them eminently suitable for Narrowboat use, many of these items are also available in full offshore marine spec produced entirely in stainless steel for saltwater applications. Please contact us to have this specification manufactured to order by request.

Our New Nautic glass cooker tops are full marine spec as standard, marine pan holders are available to order with the hobs having the location point installed by request. We carry in stock a range of High spec AGM batteries. We have from stock the well received Waeco CR & MDC compressor refrigerator range with marine installation frames available. Pages 30-35 contain our highly regarded range of chromed brass Designer Ultimate taps and showers operating with ceramic valves for reliability. On page 127 we have a great range of Marine heads at a great price without any compromise on our reputation for quality products. We also have an extensive range of flexible Nautic tanks to allow additional water, waste & fuel to be carried in the most awkward shaped places.

## MARINE Page 126-131

<b>DECK FILLERS</b>	<b>TOILET WASTE PUMPS</b>
<b>SCREENED VENT</b>	<b>BILGE STRAINERS</b>
<b>SKIN FITTINGS</b>	<b>HAND &amp; FOOT OPERATED PUMPS</b>
<b>MARINEFLEX HOSE</b>	<b>ELECTRIC TOILETS</b>
<b>PUMP STRAINER</b>	<b>Y VALVES</b>
<b>BILGE PUMPS</b>	<b>CARBON VENT FILTER</b>
<b>FLOAT SWITCHES</b>	<b>VENTED LOOPS</b>
<b>SUPERSUB PUMP</b>	<b>NAUTIC BOILERS &amp; CALORIFIERS</b>
<b>DIVERTER VALVES</b>	<b>SHURFLO MARINE FRESH PUMPS</b>
<b>DRAIN &amp; WASTE PUMPS</b>	<b>NAUTIC FLEXIBLE TANKS</b>

Take a browse through the complete catalogue to pinpoint products that meet all your needs. Any queries then please drop us a mail or give us a call, we are always here to help.

**WE CAN NOW OFFER THE FULL JABSCO, RULE AND FLOJET HIGH QUALITY MARINE PRODUCTS RANGE. PLEASE CONTACT WITH YOUR REQUIREMENTS AND WE WILL CONFIRM PRICES**

**AQUA HOUSE, 10 PRINCES DRIVE INDUSTRIAL ESTATE, KENILWORTH, WARWICKSHIRE, CV8 2FD.**

**ORDERLINE 0844 414 2324 FAX: 0844 414 2425**

**sales@nauticproducts.co.uk www.nauticproducts.co.uk**

**sales@caktanks.com www.caktanks.com**

**Trade & Export enquiries: sales@caktanks.co.uk**

### NEW SHURFLO MARINE FRESH WATER PUMPS

#### Shurflo Aqua King Pumps

SHURflo Marine pumps guarantee quiet operation and smooth performance while providing the ultimate in durability and reliability. Designed and built specifically for the harsh marine environment, SHURflo pumps are equipped with sealed switches and seamless e-coated motors. CE marked, Thermally Protected & Ignition Protected. 3 Year Warranty. Filters for Aquaking pumps see pics A to D page 27)

**SFM3901-0213** Aqua King Standard 3.0 12v DC 5A Flow 11.35 Lpm (3GPM) 30psi Size 184 x 127 x 118mm (pic B)

#### PAR-Max 1

Miniature multi outlet water pressure pump serves 1 or 2 3/8" (10mm) outlets at any one time. Models include both automatic and manual pumps. 1.1 gpm (4.3 lpm) open flow output. Self-priming up to 4ft (1.2m), Dual diaphragm operation, Thermal overload protection automatically stops motor should it overheat due to overload, with auto re-start feature, Diaphragm design allows dry running, Pressure switch cut-in 22 psi (1.5 bar), cut-out 35 psi (2.4 bar), Fitting: Connections for 3/8" (10mm) ID hose and slip-on 1/2" (13mm) bushings. Size: 6.4" long x 3.5" wide x 2.3" high (16cm x 9cm x 6cm).

**JM42630-2900** PARMAX 1 4.3LPM 22-35PSI 12V AUTO

**JM42631-2900** PARMAX 1 4.3LPM 12V MANUAL

#### JABSCO MARINE PAR-Max 1.9

The PAR-Max 1.9 Water System Pumps is designed for vessels requiring a smooth low flow, 12 or 24 volt DC pump at an attractive low price. This new pump is internally grounded, three chamber diaphragm on-demand pump with the performance characteristics to match the needs of a typical vessel with a shower, water heater and up to three faucets. Fitting: Hose barb or NPT (both supplied). Size: 9" long x 4.5" wide x 4.5" high (23cm x 11cm x 11cm). Weight: 3lb (1.4kg). Flow: 0-1.9 gpm (0-7.2 lpm).

**JM31295-0092** PARMAX 1.9 PUMP 12V 25PSI 7.2 LPM 1.9GPM

#### JABSCO MARINE PAR-Max 2.9

The PAR-Max 2.9 Water System offers a smooth flow of up to 2.9 gpm (10.9 lpm) and is fitted with a built in pulsation dampening bypass to control unwanted cycling and noise. We include quick-connect fittings for ease of pump installation. Self priming up to 6-10ft (2-3m), Dry running, Soft rubber mounts, Complies with ISO 8846 MARINE (Ignition Protection), Low noise, Less pulsation in the flow, Screw-less diaphragm design eliminates possible leak paths, Distinctive style, Can eliminate the requirement for an accumulator tank. Fitting: Hose barb or NPT (both supplied). Size: 9" long x 4.5" wide x 4.5" high (23cm x 11cm x 11cm). Weight: 4lb (1.8kg). Flow: 0-2.9 gpm (0-10.9 lpm).

**JM31395-0092** PARMAX 2.9 PUMP 12V 25PSI 10.9 LPM 2.9GPM

**JM31395-0094** PARMAX 2.9 PUMP 24V 25PSI 10.9 LPM 2.9GPM

**JM31395-0392** PARMAX 2.9 PUMP 12V 40PSI 10.9 LPM 2.9GPM

**JM31395-0394** PARMAX 2.9 PUMP 24V 40PSI 10.9 LPM 2.9GPM

#### PAR-Max 3.5 Water System Pump

This conventional pressure switch controlled pump enjoys the same pulsation free 3 chamber diaphragm design as our PAR-Max 2.9 & 1.9 but incorporates a heavy duty motor, giving higher flows and long life for such a small footprint. Like all Jabsco water pressure system pumps it is inherently quiet, self-priming and can run dry without damage. Quickconnect fittings are included. Self priming up to 3m (10ft). Fitting: 2 x 1/2" Male.

**JM32600-0292** PARMAX 3.5GPM 13.2LPM 12V 25PSI

**JM32600-0294** PARMAX 3.5GPM 13.2LPM 24V 25PSI



**JM42630**



**JM31295**



**JM31395**



**JM32600**

**0844 414 2324 ORDERLINE**  
sales caktanks.com www.caktanks.com

**THE COMPLETE WATER SYSTEMS AND  
INTERIOR EQUIPMENT SPECIALIST**

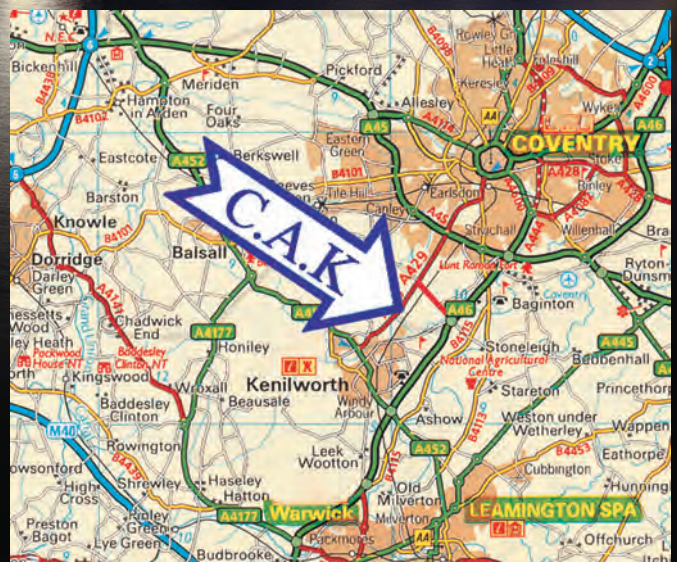
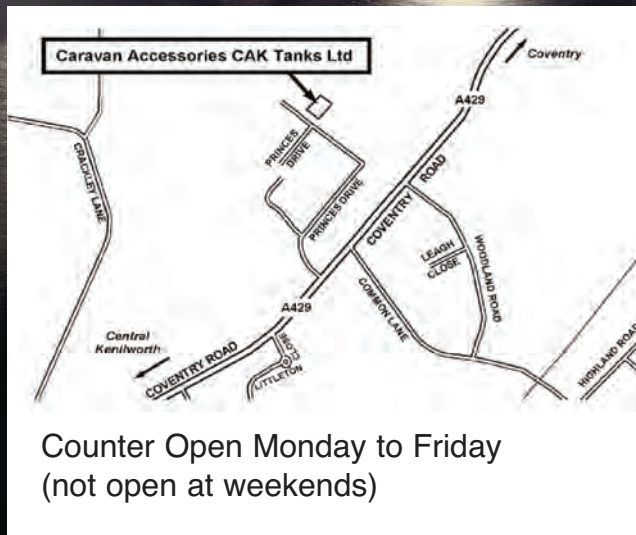

**AQUA HOUSE**

10 PRINCES DRIVE IND ESTATE, KENILWORTH,  
WARWICKSHIRE, CV8 2FD. UNITED KINGDOM

**FAX: 0844 414 2425**

**Telephone International: 44(0)1926 854271**

**CARAVAN ACCESSORIES C.A.K. TANKS LTD**